

CENTURY  
LIGHTING



ARCHITECTURAL LIGHTING



We are specialising on "Lighting Innovation".  
Let people feel the joy of light.

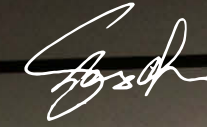



INDEX

**NAKO**

Visible



Invisible



**P001**

---

**FOCUS**



**P023**

---

**KAKU**



**P043**

**MOBO**

Glass



Diffuse



**P057**

---

**DEEP AUDA**



**P073**

---

**AUDA**



**P097**

**A01**

**SIMP A**



**P117**

---

**SIMP B**



**P139**

**TINA**



**P149**

---

**INCO**



**P163**

---

**WATA**



**P173**

INDEX

**PODO**



**P189**

---

**ROSU**



**P197**

---

**P197**

**A02**

**STAR**

Recessed



Surface-mounted



**P217**

---

**PANA**



**P235**



INDEX

**RONO R**



**P241**

**RONO S**

Visible



Invisible



**P257**

**FUTW**

Visible



Invisible



Surface-mounted



**P289**

**BOX**

Visible



Invisible



**P315**

**MILA**



**P345**

**TOPO**



**P355**

**TODO**

Surface-mounted



Pendant



**P381**

**PEDA**



**P389**

INDEX

**LINA**

Surface-mounted



Pendant



**P399**

**DACU**



**P411**

**SOPO**

Track



Surface-mounted



Recessed



**P423**

A03

A04



# INDEX

## WALA

Interior



Exterior



**P481**

## FOCE

Recessed



Pendant



**P507**

## DRIVER

**P521**

---

## LIGHT SOURCE

**P522**

---

**DATA**

**P523**

---

**ICONS**

**P525**

---

## PRODUCT CODES

**P526**

# PRODUCTS

- Track Spot Light
- Surface-Mounted Spot Light
- Recessed Spot Light
- Down Light
- Wall Wash Light
- Wall Light
- Surface-Mounted Light
- Pendant Light
- Office Light



# NAKO

Superior optical lens for different beam angles.  
The nice baffles for different finishing colors.  
Visible and invisible installation types for option.

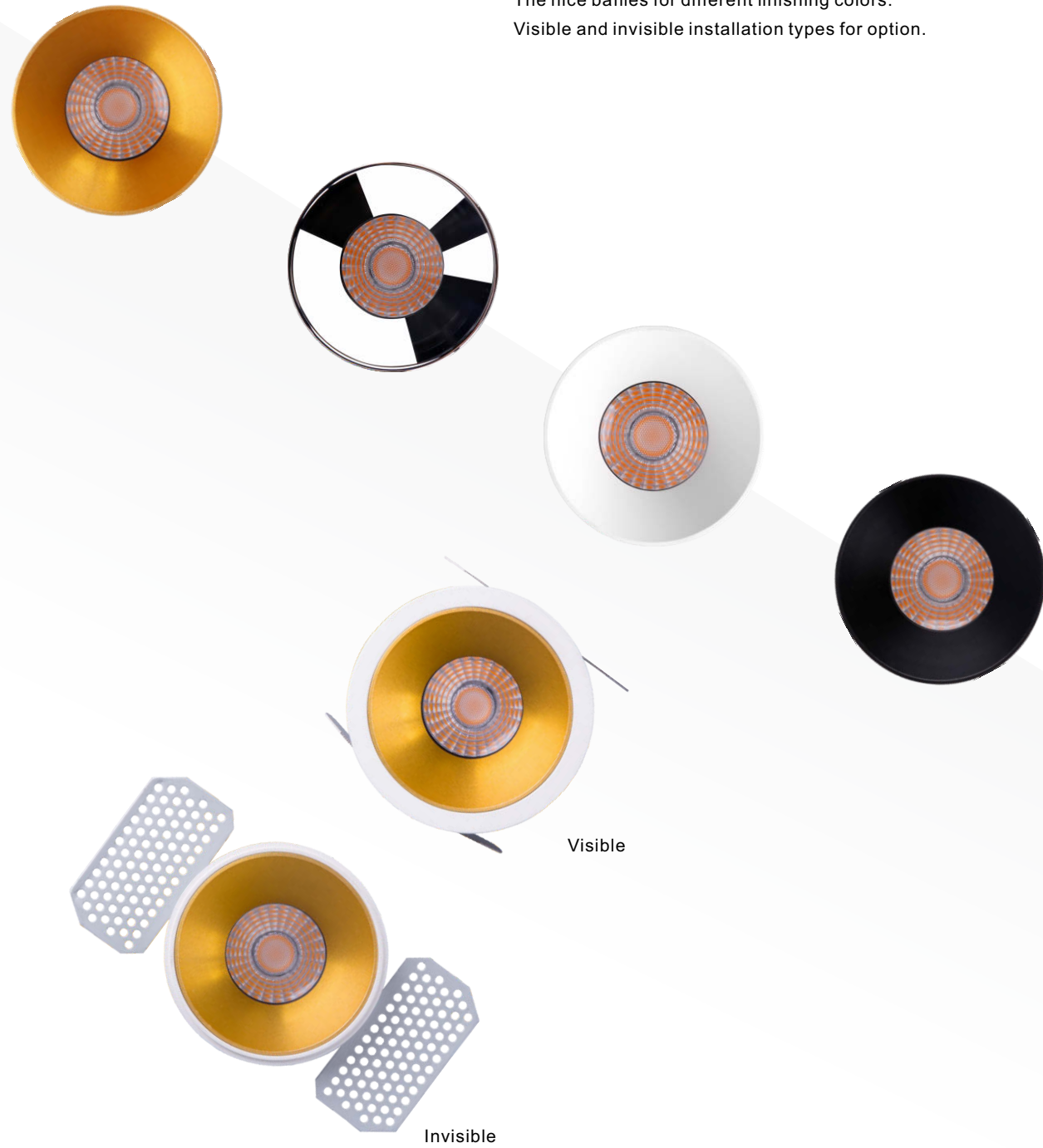

# NAKO

Invisible

Visible



First,  
install the mounting frame to the ceiling;

Second,  
install power lines;

Third,  
embed the lamp in the component.



NAKO



Spring Ball  
Sticking

Combine with ceiling components  
Install lamps more easily



003

NAKO



COB LED  
6W 10W  
24° 36° 60°

Reflector  
Lamp body

Mounting Frame  
Invisible and Visible Versions

004



NAKO



005

NAKO



006

NAKO



007

NAKO

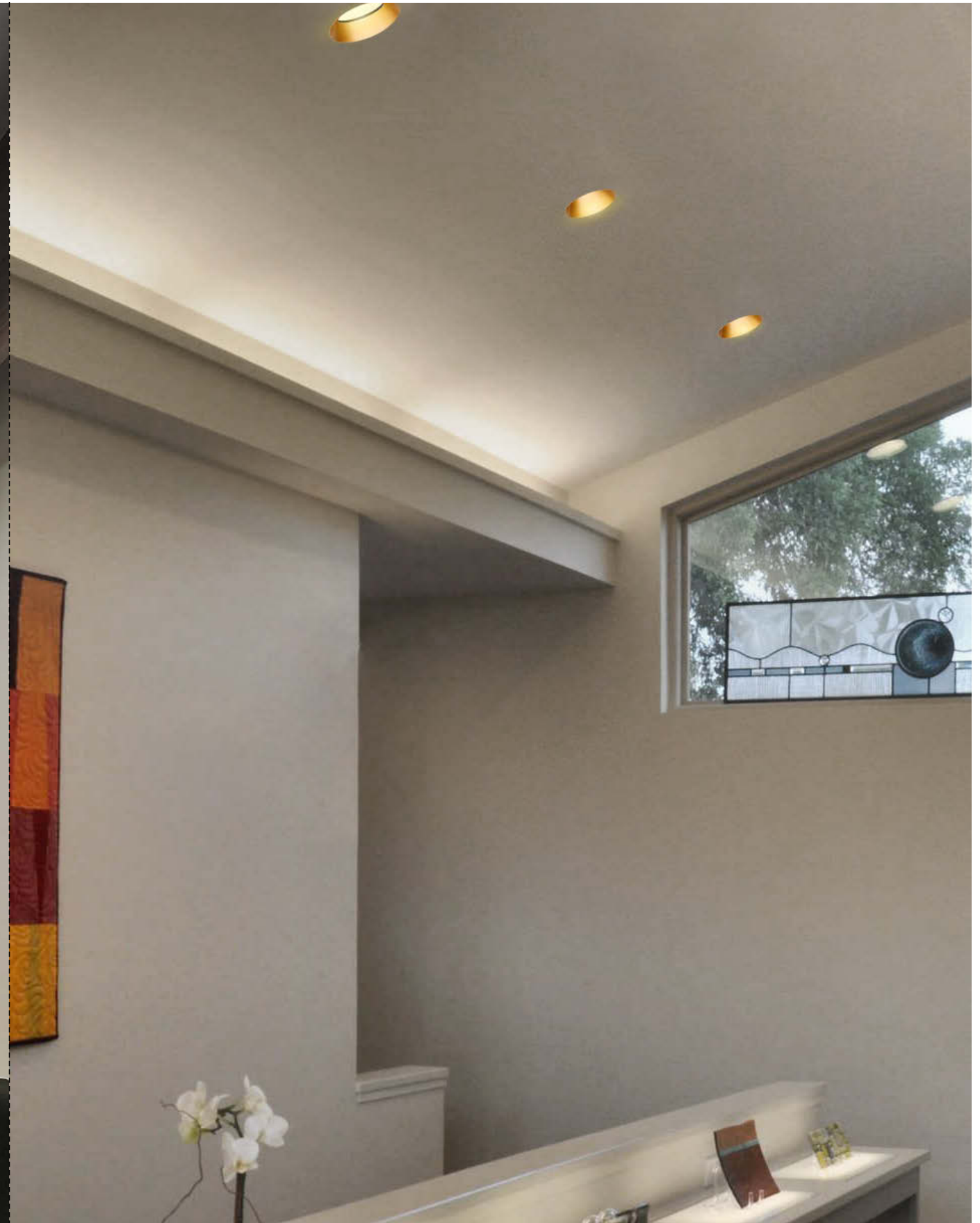

008



# NAKO

## Visible-fixed



RG (gold)



RM (mirror)



RW (white)



RB (black)



P011



P012



P013



P014



P015



P016

S Ø 88mm 6W 10W / 15W

M Ø 100mm 15W 20W

L Ø 124mm 20W 25W

Ø 100mm 10W

Ø 100mm 6W 10W

# NAKO

## Invisible-fixed



RG (gold)



RM (mirror)



RW (white)



RB (black)



P017



P018



P019



P020



P021



P022

S Ø 78.5mm 6W 10W / 15W

M Ø 90mm 15W 20W

L Ø 112mm 20W 25W

Ø 92mm 10W

Ø 92mm 6W 10W



**COB LED CRI≥80 IP44 CE RoHS**

Reflector color:     
 RG RM RW RB

Mounting frame color: White Silver Black  
 Color temperature: 2700K 3000K 4000K  
 Beam angle: 24° 36° 60°

Driver gear for LED: Non-Dimmable  
 1-10V Dimmable  
 DALI Dimmable  
 Triac Dimmable

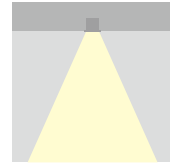

- Housing: Cast aluminum.
- Mounting ring: Pure aluminum.
- Anti-dazzle ring: Pure aluminum.
- Light source: COB LED with a lens of optical.
- Embedded parts make it easy to install and remove so as to protect ceiling.
- The light can be compatible with emergency battery.
- UGR<19.

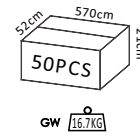
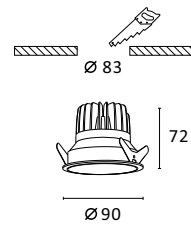

**R6340 6W 460lm**  
 With LED Driver 36V-135mA  
 230V-50Hz

NW  
 0.27kg

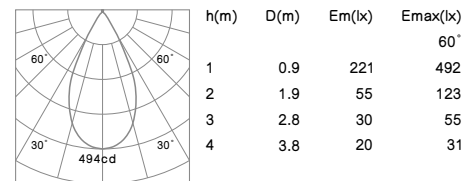
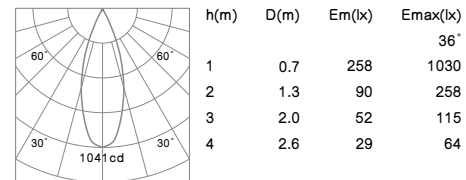
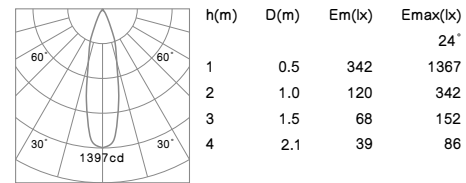

**R6340 10W 800lm**  
 With LED Driver 36V-250mA  
 230V-50Hz

NW  
 0.27kg

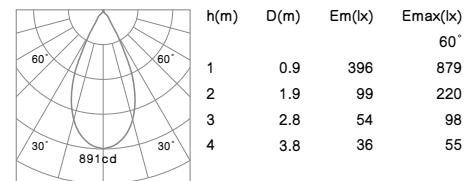
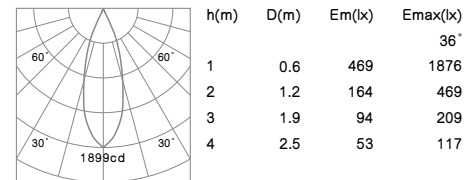
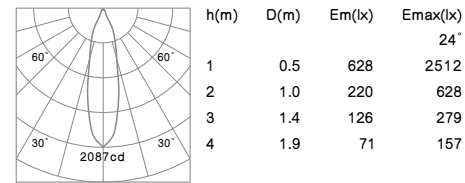

**COB LED CRI≥80 IP44 CE RoHS**

Reflector color:     
 RG RM RW RB

Mounting frame color: White Silver Black  
 Color temperature: 2700K 3000K 4000K  
 Beam angle: 15° 24° 36° 60°

Driver gear for LED: Non-Dimmable  
 1-10V Dimmable  
 DALI Dimmable  
 Triac Dimmable

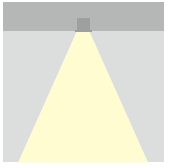

- Housing: Cast aluminum.
- Mounting ring: Pure aluminum.
- Anti-dazzle ring: Pure aluminum.
- Light source: COB LED with a lens of optical.
- Embedded parts make it easy to install and remove so as to protect ceiling.
- The light can be compatible with emergency battery.
- UGR<19.

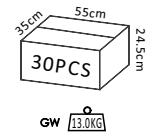
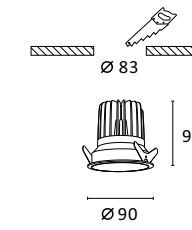

**R6341 15W 1000lm**  
 With LED Driver 36V-350mA  
 230V-50Hz

NW  
 0.35kg

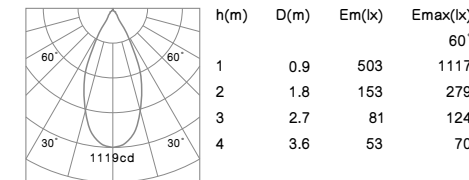
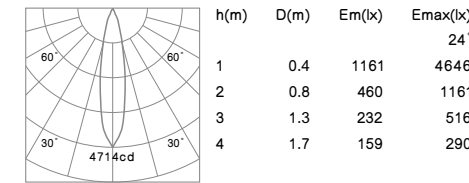
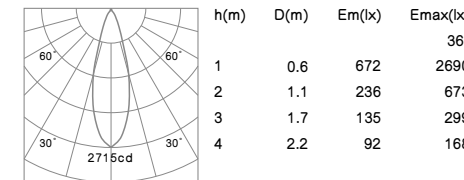
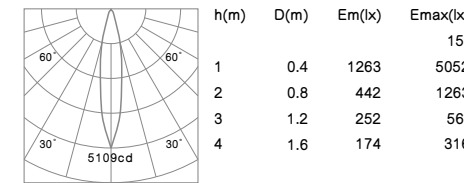



NAKO Visible-fixed M



COB LED	CRI≥80	IP44	CE	RoHS
Reflector color:				
	RG	RM	RW	RB
Mounting frame color:				
	White	Silver	Black	
Color temperature:				
	2700K	3000K	4000K	
Beam angle:				
	15°	24°	36°	
Driver gear for LED:				
	Non-Dimmable			
	1-10V Dimmable			
	DALI Dimmable			
	Triac Dimmable			

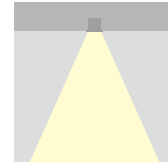

- Housing: Cast aluminum.
- Mounting ring: Pure aluminum.
- Anti-dazzle ring: Pure aluminum.
- Light source: COB LED with a lens of optical.
- Embedded parts make it easy to install and remove so as to protect ceiling.
- The light can be compatible with emergency battery.
- UGR<19.

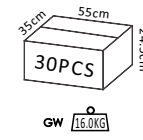
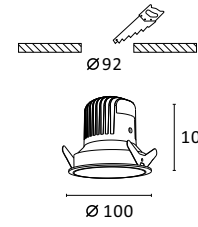

R6342 15W 1200lm  
With LED Driver 36V-350mA  
230V-50Hz

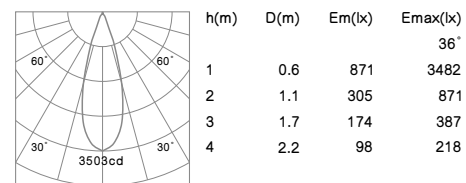
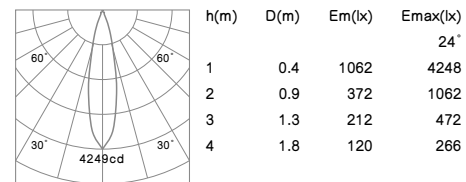
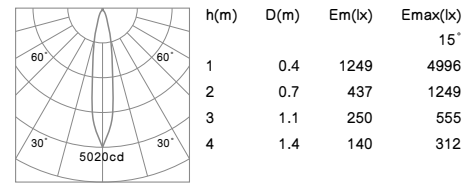

R6342 20W 1450lm  
With LED Driver 36V-500mA  
230V-50Hz

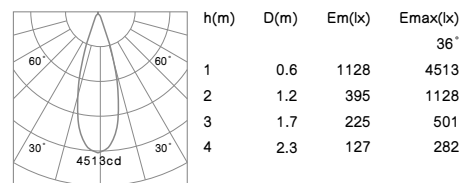
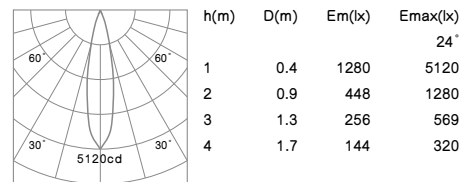
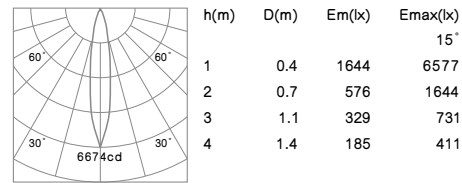

NAKO Visible-fixed L



COB LED	CRI≥80	IP44	CE	RoHS
Reflector color:				
	RG	RM	RW	RB
Mounting frame color:				
	White	Silver	Black	
Color temperature:				
	2700K	3000K	4000K	
Beam angle:				
	15°	24°	45°	
Driver gear for LED:				
	Non-Dimmable			
	1-10V Dimmable			
	DALI Dimmable			
	Triac Dimmable			

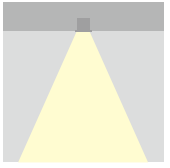

- Housing: Cast aluminum.
- Mounting ring: Pure aluminum.
- Anti-dazzle ring: Pure aluminum.
- Light source: COB LED with a lens of optical.
- Embedded parts make it easy to install and remove so as to protect ceiling.
- The light can be compatible with emergency battery.
- UGR<19.

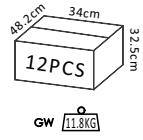
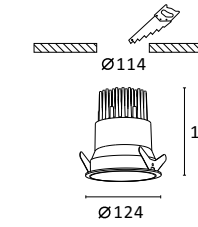

R6343 20W 1900lm  
With LED Driver 36V-500mA  
230V-50Hz

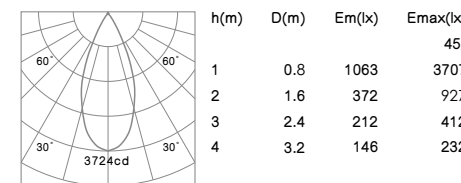
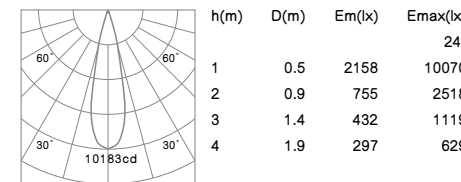
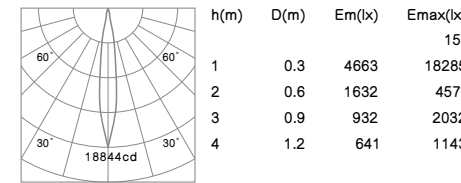

R6343 25W 2390lm  
With LED Driver 36V-600mA  
230V-50Hz

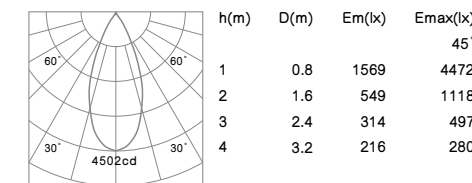
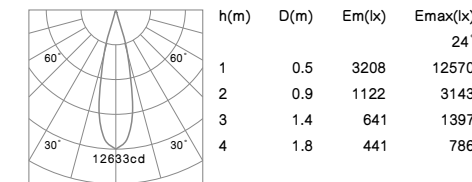
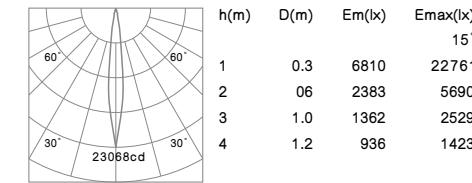

# NAKO Visible-adjustable T

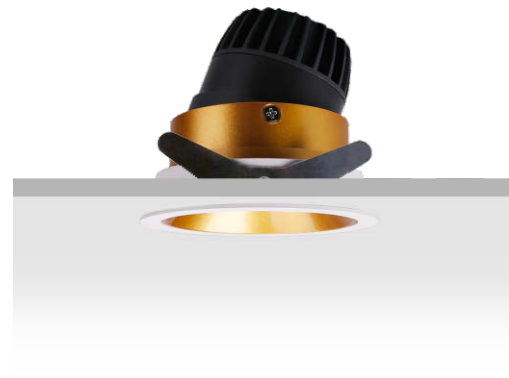

COB LED CRI≥80 IP65 CE RoHS

Reflector color:      
 RG RM RW RB

Mounting frame color: White Silver Black  
 Color temperature: 2700K 3000K 4000K  
 Beam angle: 24° 36° 60°

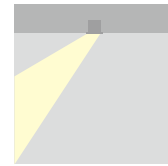

- Housing: Cast aluminum.
- Mounting ring: Pure aluminum.
- Anti-dazzle ring: Pure aluminum.
- Light source: COB LED with a lens of optical.
- The spot light tilts to a maximum of 0-30° onto the vertical plane.
- Embedded parts make it easy to install and remove so as to protect ceiling.
- The light can be compatible with emergency battery.
- UGR<19.

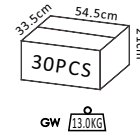
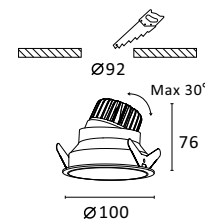

**E6028 10W 700lm**  
 With LED Driver 36V-250mA  
 230V-50Hz

NW  
 0.35kg

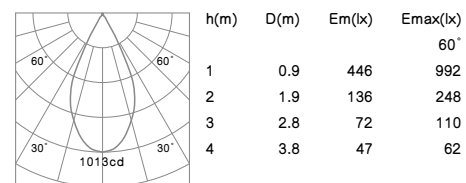
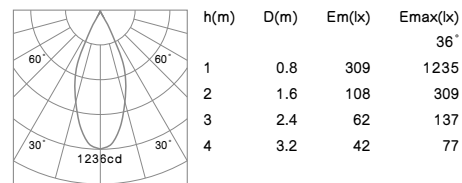
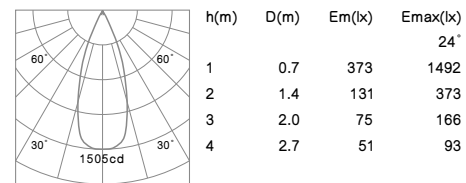

# NAKO Visible-adjustable T



COB LED CRI≥80 IP44 CE RoHS

Reflector color:      
 RG RM RW RB

Mounting frame color: White Silver Black  
 Color temperature: 2700K 3000K 4000K  
 Beam angle: 24° 36° 60°

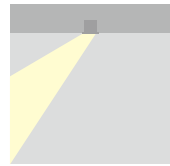

Driver gear for LED: Non-Dimmable  
 1-10V Dimmable  
 DALI Dimmable  
 Triac Dimmable

- Housing: Cast aluminum.
- Mounting ring: Pure aluminum.
- Anti-dazzle ring: Pure aluminum.
- Light source: COB LED with a lens of optical.
- The spot light tilts to a maximum of 0-30° onto the vertical plane.
- Embedded parts make it easy to install and remove so as to protect ceiling.
- The light can be compatible with emergency battery.
- UGR<19.

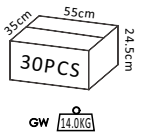
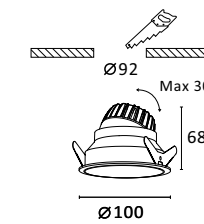

**R6897 6W 380lm**  
 With LED Driver 36V-135mA  
 230V-50Hz

NW  
 0.39kg

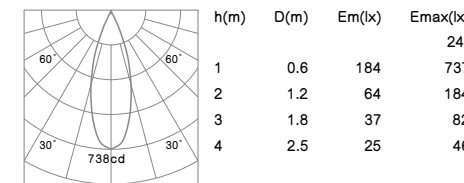

**R6897 10W 650lm**  
 With LED Driver 36V-250mA  
 230V-50Hz

NW  
 0.39kg

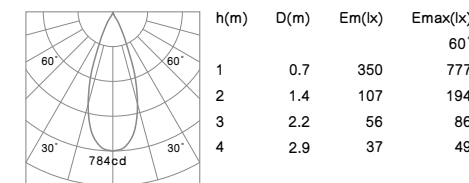
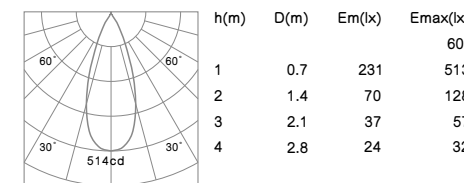
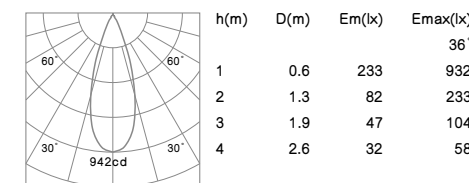
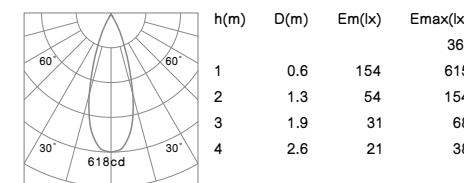
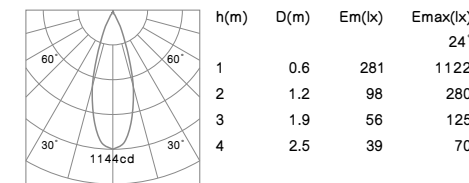





COB LED CRI≥80 IP44 CE RoHS

Reflector color:      
 RG RM RW RB  
 Color temperature: 2700K 3000K 4000K  
 Beam angle: 24° 36° 60°

Driver gear for LED: Non-Dimmable  
 1-10V Dimmable  
 DALI Dimmable  
 Triac Dimmable

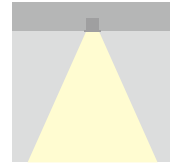

- Housing: Cast aluminum.
- Mounting ring: Pure aluminum.
- Anti-dazzle ring: Pure aluminum.
- Light source: COB LED with a lens of optical.
- Embedded parts make it easy to install and remove so as to protect ceiling.
- The light can be compatible with emergency battery.
- UGR<19.

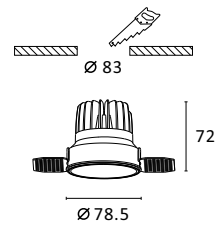

COB LED

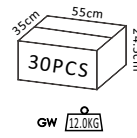

R6309 6W 460lm  
 With LED Driver 36V-135mA  
 230V-50Hz

NW  
 0.32kg

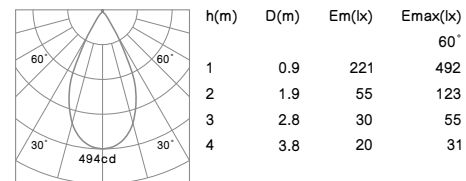
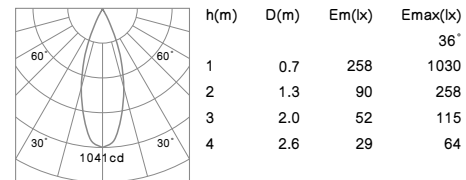
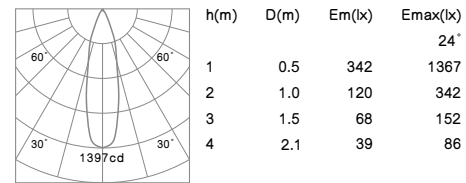

R6309 10W 800lm  
 With LED Driver 36V-250mA  
 230V-50Hz

NW  
 0.32kg

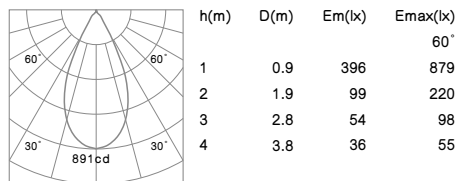
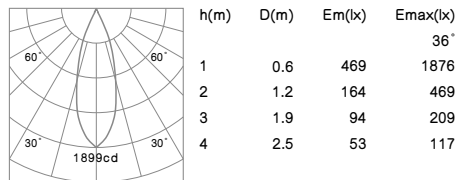
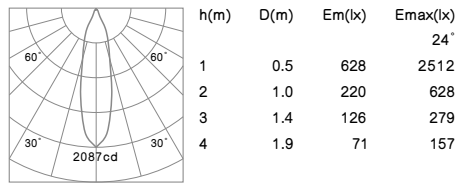

COB LED CRI≥80 IP44 CE RoHS

Reflector color:      
 RG RM RW RB  
 Color temperature: 2700K 3000K 4000K  
 Beam angle: 15° 24° 36° 60°

Driver gear for LED: Non-Dimmable  
 1-10V Dimmable  
 DALI Dimmable  
 Triac Dimmable

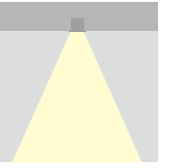

- Housing: Cast aluminum.
- Mounting ring: Pure aluminum.
- Anti-dazzle ring: Pure aluminum.
- Light source: COB LED with a lens of optical.
- Embedded parts make it easy to install and remove so as to protect ceiling.
- The light can be compatible with emergency battery.
- UGR<19.

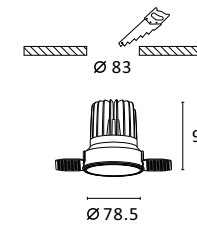

COB LED

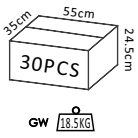

R6315 15W 1000lm  
 With LED Driver 36V-350mA  
 230V-50Hz

NW  
 0.54kg

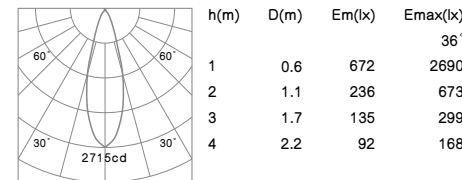
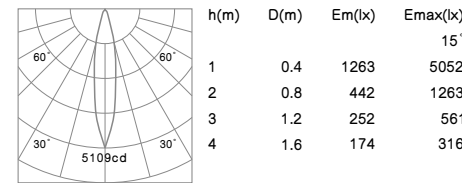

NAKO Invisible-fixed M



COB LED CRI≥80 IP44 CE RoHS

Reflector color:      
 RG RM RW RB  
 Color temperature: 2700K 3000K 4000K  
 Beam angle: 15° 24° 36°

Driver gear for LED: Non-Dimmable  
 1-10V Dimmable  
 DALI Dimmable  
 Triac Dimmable

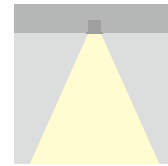

- Housing: Cast aluminum.
- Mounting ring: Pure aluminum.
- Anti-dazzle ring: Pure aluminum.
- Light source: COB LED with a lens of optical.
- Embedded parts make it easy to install and remove so as to protect ceiling.
- The light can be compatible with emergency battery.
- UGR<19.

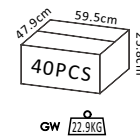
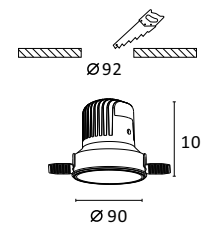

R6310 15W 1200lm  
 With LED Driver 36V-350mA  
 230V-50Hz

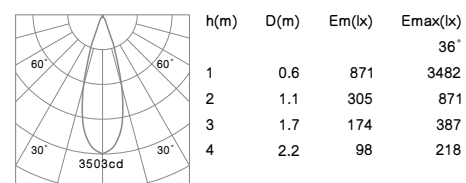
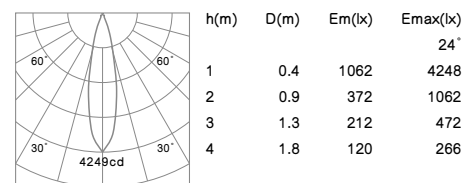
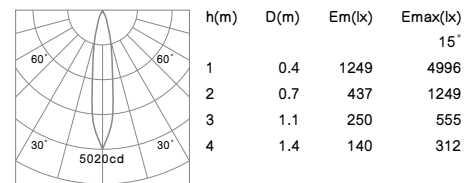

R6310 20W 1450lm  
 With LED Driver 36V-500mA  
 230V-50Hz

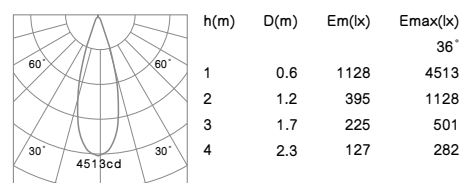
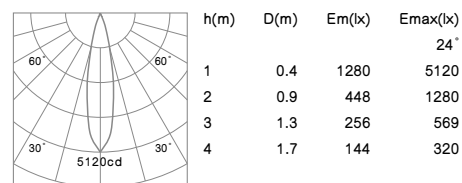
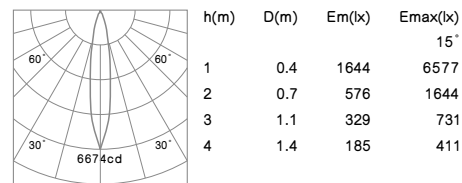

NAKO Invisible-fixed L



COB LED CRI≥80 IP44 CE RoHS

Reflector color:      
 RG RM RW RB  
 Color temperature: 2700K 3000K 4000K  
 Beam angle: 15° 24° 45°

Driver gear for LED: Non-Dimmable  
 1-10V Dimmable  
 DALI Dimmable  
 Triac Dimmable

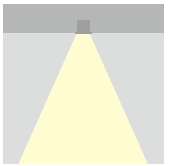

- Housing: Cast aluminum.
- Mounting ring: Pure aluminum.
- Anti-dazzle ring: Pure aluminum.
- Light source: COB LED with a lens of optical.
- Embedded parts make it easy to install and remove so as to protect ceiling.
- The light can be compatible with emergency battery.
- UGR<19.

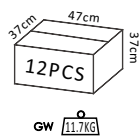
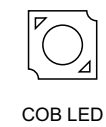
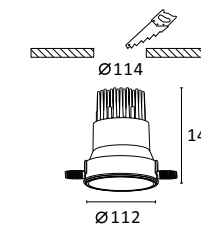

R6311 20W 1900lm  
 With LED Driver 36V-500mA  
 230V-50Hz

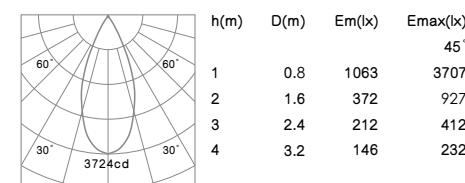
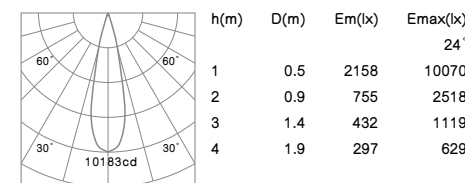
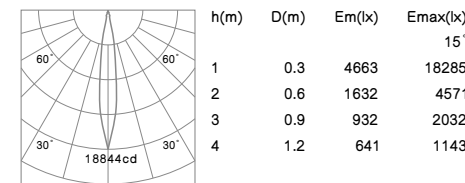

R6311 25W 2390lm  
 With LED Driver 36V-600mA  
 230V-50Hz

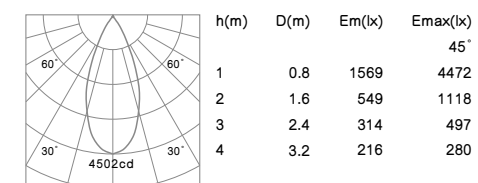
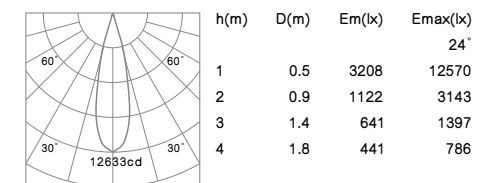
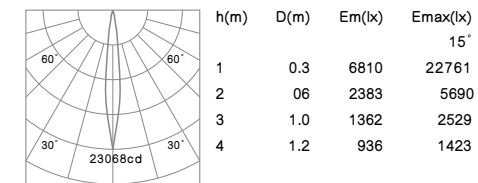

NAKO Invisible-adjustable T



COB LED CRI≥80 IP65 CE RoHS  
 Reflector color: RG RM RW RB  
 Color temperature: 2700K 3000K 4000K  
 Beam angle: 24° 36° 60°

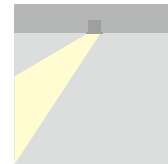

- Housing: Cast aluminum.
- Mounting ring: Pure aluminum.
- Anti-dazzle ring: Pure aluminum.
- Light source: COB LED with a lens of optical.
- The spot light tilts to a maximum of 0-30° onto the vertical plane.
- Embedded parts make it easy to install and remove so as to protect ceiling.
- The light can be compatible with emergency battery.
- UGR<19.

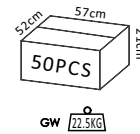
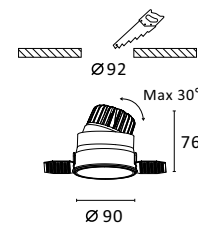

E6027 10W 700lm  
 With LED Driver 36V-250mA  
 230V-50Hz

NW  
 0.38kg

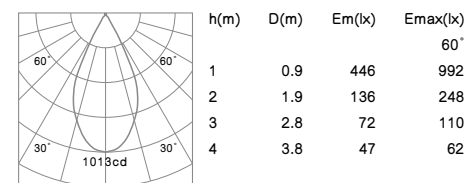
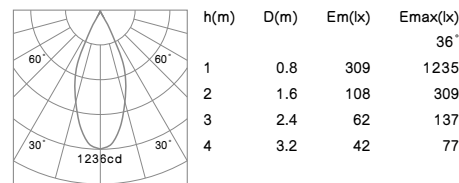
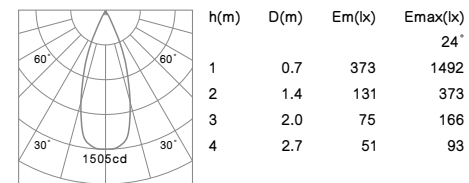

NAKO Invisible-adjustable T



COB LED CRI≥80 IP44 CE RoHS  
 Reflector color: RG RM RW RB  
 Color temperature: 2700K 3000K 4000K  
 Beam angle: 24° 36° 60°

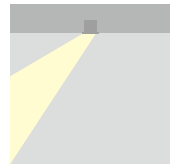

Driver gear for LED: Non-Dimmable  
 1-10V Dimmable  
 DALI Dimmable  
 Triac Dimmable

- Housing: Cast aluminum.
- Mounting ring: Pure aluminum.
- Anti-dazzle ring: Pure aluminum.
- Light source: COB LED with a lens of optical.
- The spot light tilts to a maximum of 0-30° onto the vertical plane.
- Embedded parts make it easy to install and remove so as to protect ceiling.
- The light can be compatible with emergency battery.
- UGR<19.

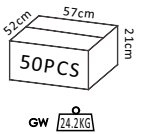
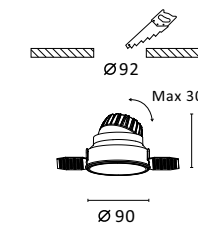

R6894 6W 380lm  
 With LED Driver 36V-135mA  
 230V-50Hz

NW  
 0.42kg

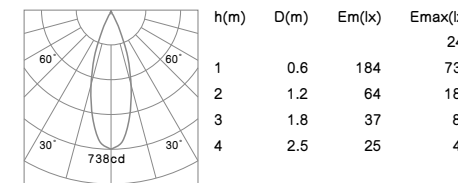

R6894 10W 650lm  
 With LED Driver 36V-250mA  
 230V-50Hz

NW  
 0.42kg

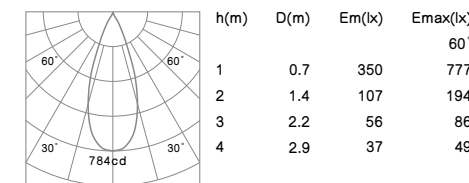
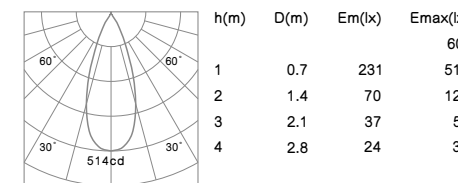
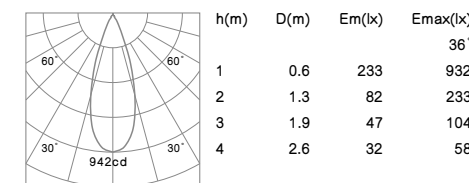
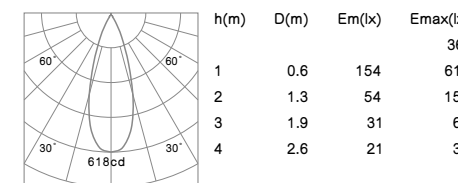
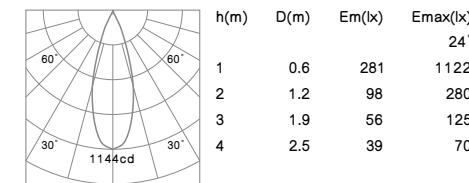



# FOCUS



Visible  
RM (mirror)



Invisible  
RG (champagne gold)



Visible  
RD (dark chrome)

023

# FOCUS

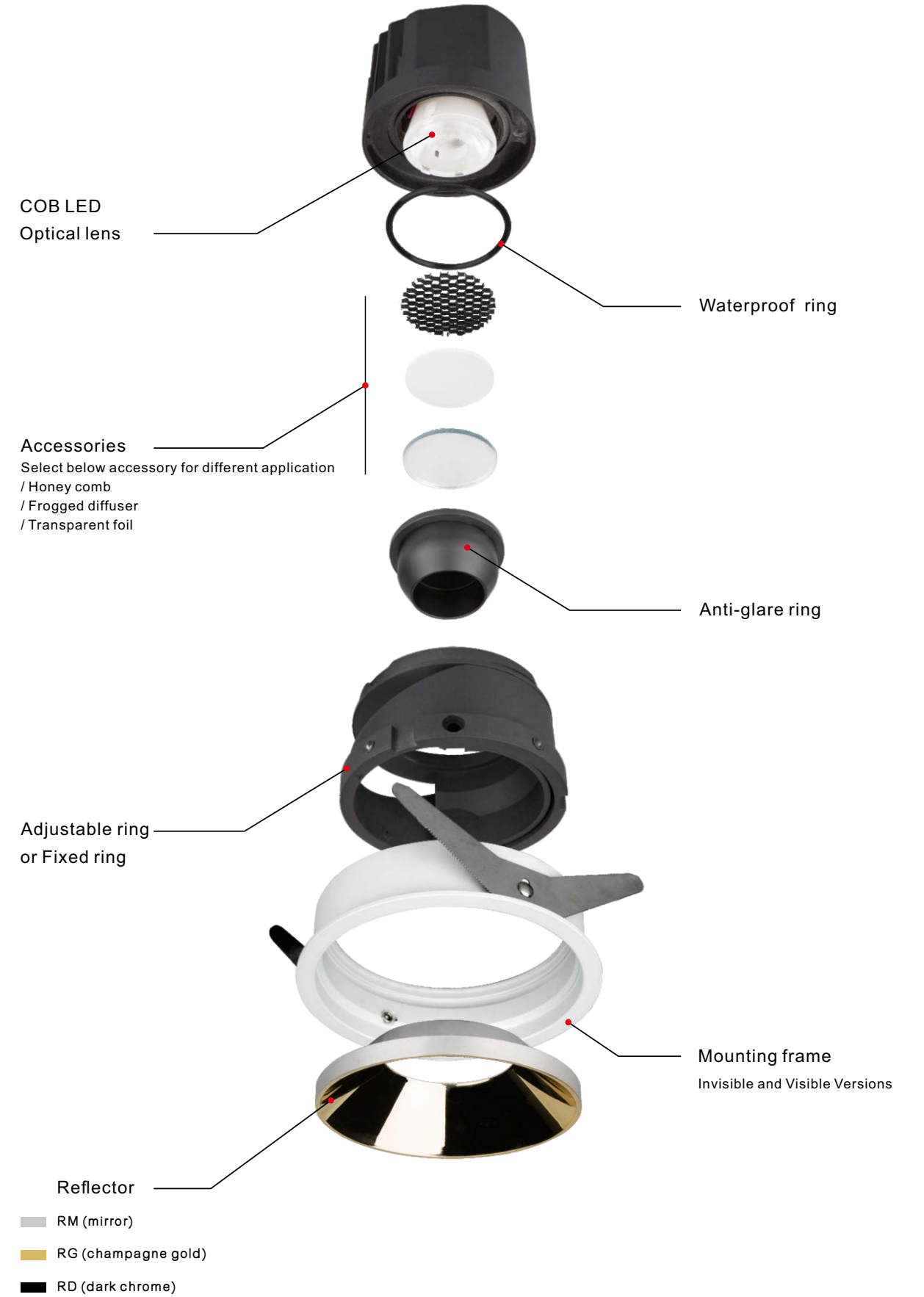

024

## FOCUS



- Die casting process, simple and exquisite appearance, and good heat dissipation performance.
- The new design of trimless and narrow edge frame to blend the ceiling perfectly
- Split structure and the design of frame embedded to avoid ceiling damage during maintenance.
- The reflector structure can make extreme anti-glare and excellent lighting effect.
- Vertical rotation at 30 degrees, horizontal rotation at 355 degrees, suitable for various applications.
- Silver mirror, dark chrome, champagne gold, multi-color reflectors can be provided, suitable for various environments.
- IP65 is available.
- UGR $\leq$ 10.

025

## FOCUS

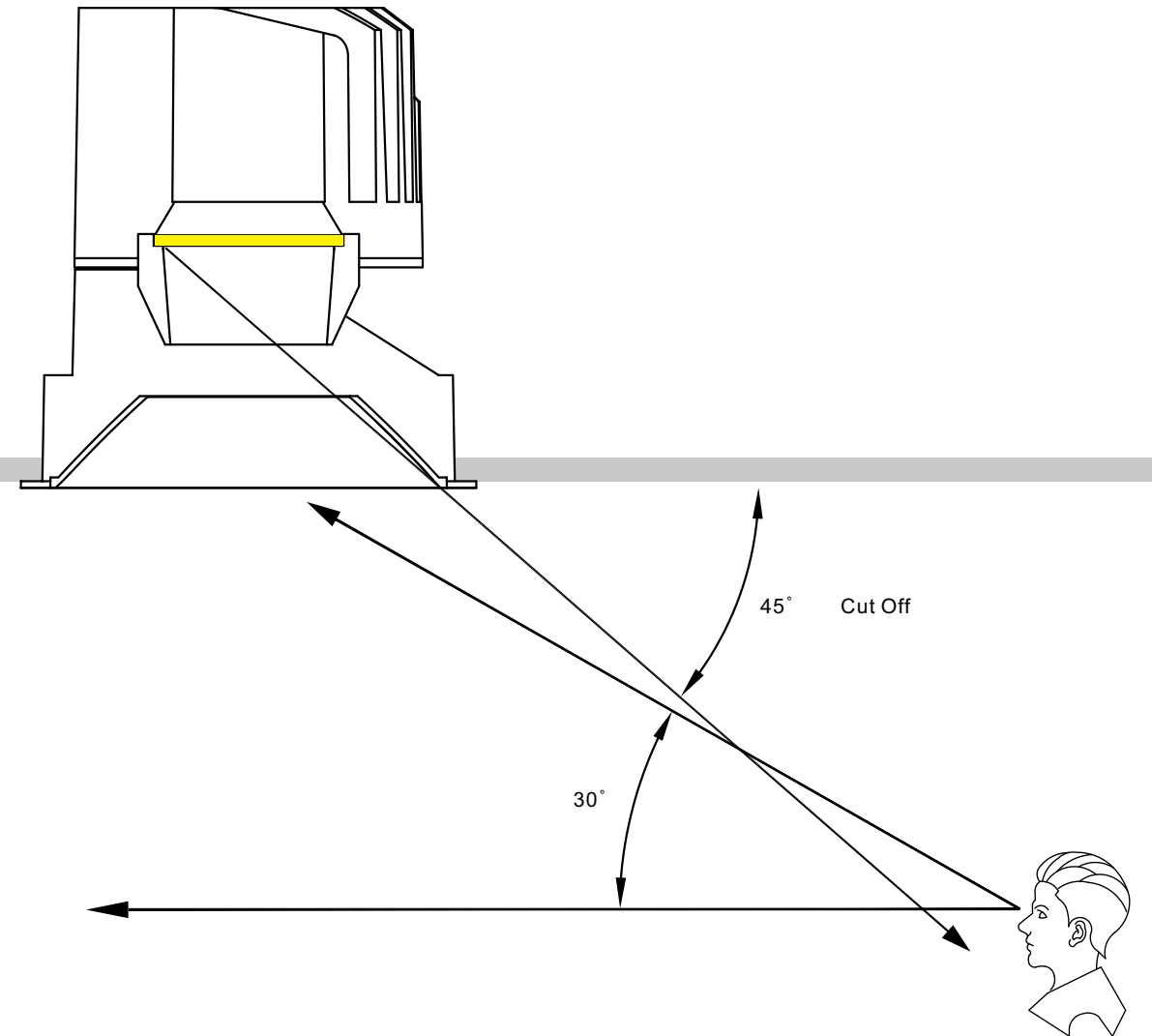

**Cut Off Angle**

026



FOCUS

FOCUS





# FOCUS



# FOCUS

## Visible



RM (mirror)



RG (champagne gold)



RD (dark chrome)



Ø 110mm 6W 10W 15W 20W

P031



Ø 110mm 6W 10W 15W 20W

P034

## Invisible



RM (mirror)



RG (champagne gold)



RD (dark chrome)



Ø 102mm 6W 10W 15W 20W

P037



Ø 102mm 6W 10W 15W 20W

P040

# FOCUS Visible-fixed



**COB LED CRI≥80 IP44 CE RoHS**

Reflector color:      
RM RG RD

Mounting frame color: White Silver Black  
Color temperature: 2700K 3000K 4000K  
Beam angle: 10° 24° 36°

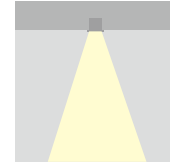

Driver gear for LED: Non-Dimmable  
1-10V Dimmable  
DALI Dimmable  
Triac Dimmable

- Die casting process, simple and exquisite appearance, and good heat dissipation performance.
- The new design of narrow edge frame to blend the ceiling perfectly.
- Split structure and the design of frame embedded to avoid ceiling damage during maintenance.
- The reflector structure can make extreme anti-glare and excellent lighting effect.
- Silver mirror, dark chrome, champagne gold, multi-color reflectors can be provided, suitable for various environments.
- IP65 is available.
- UGR≤10.

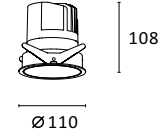
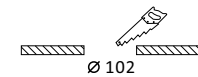

COB LED

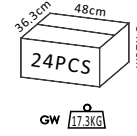

**R6299 6W 560lm**  
With LED Driver 36V-135mA  
230V-50Hz

NW  
0.65kg

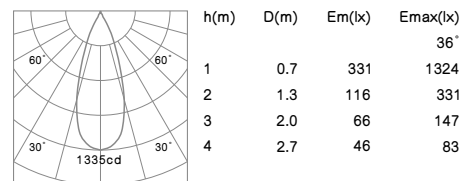
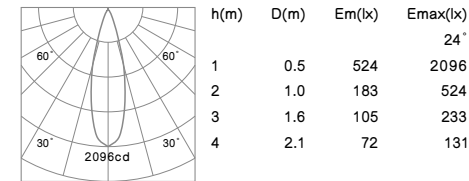
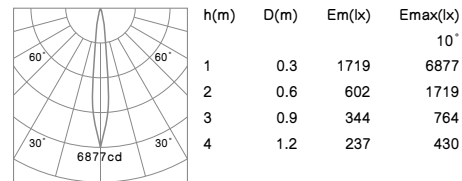

**R6299 10W 970lm**  
With LED Driver 36V-250mA  
230V-50Hz

NW  
0.65kg

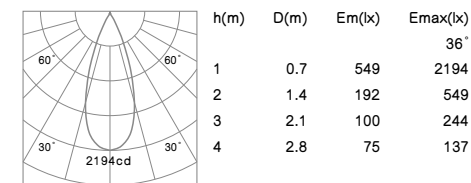
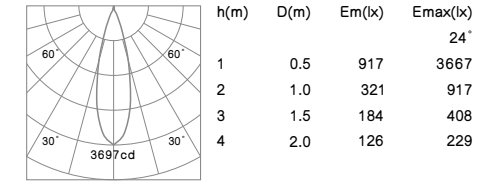
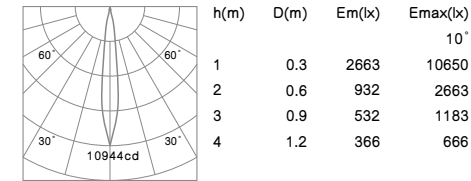

**R6299 15W 1300lm**  
With LED Driver 36V-350mA  
230V-50Hz

NW  
0.65kg

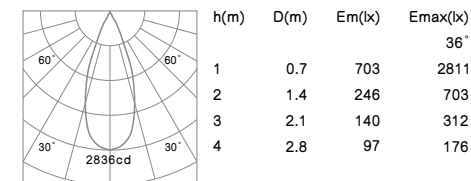
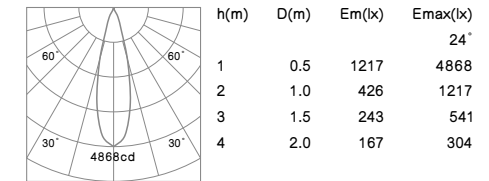
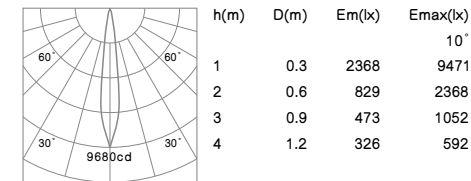



**FOCUS** Visible-fixed

**R6299 20W 1770lm**  
With LED Driver 36V-500mA  
230V-50Hz

NW  
0.65kg

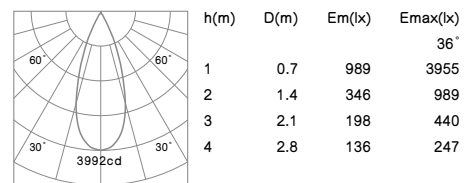
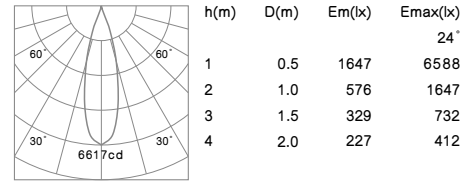
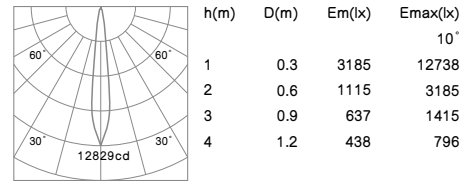

**FOCUS** Visible-adjustable



**COB LED CRI≥80 IP44 CE RoHS**

Reflector color:     
RM RG RD

Mounting frame color: White Silver Black  
Color temperature: 2700K 3000K 4000K  
Beam angle: 10° 24° 36°

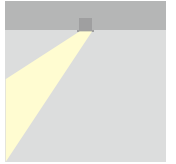

Driver gear for LED: Non-Dimmable  
1-10V Dimmable  
DALI Dimmable  
Triac Dimmable

- Die casting process, simple and exquisite appearance, and good heat dissipation performance.
- The new design of narrow edge frame to blend the ceiling perfectly.
- Split structure and the design of frame embedded to avoid ceiling damage during maintenance.
- The reflector structure can make extreme anti-glare and excellent lighting effect.
- Vertical rotation at 30 degrees, horizontal rotation at 355 degrees, suitable for various applications.
- Silver mirror, dark chrome, champagne gold, multi-color reflectors can be provided, suitable for various environments.
- IP65 is available.
- UGR≤10.

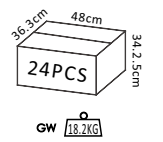
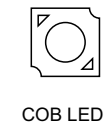
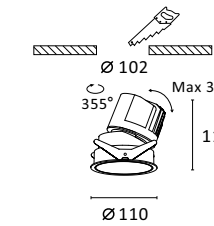

**R6296 6W 560lm**  
With LED Driver 36V-135mA  
230V-50Hz

NW  
0.69kg

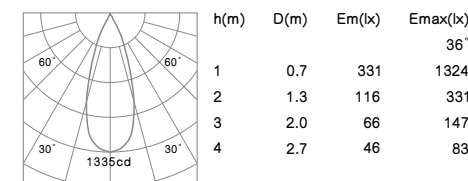
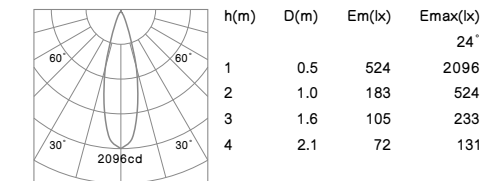
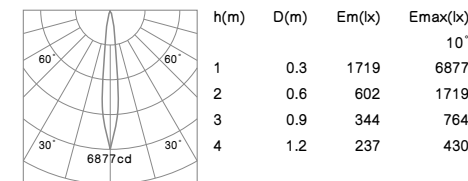

**R6296 10W 970lm**  
With LED Driver 36V-250mA  
230V-50Hz

NW  
0.69kg

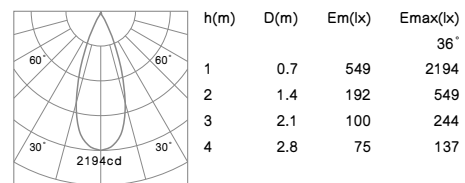
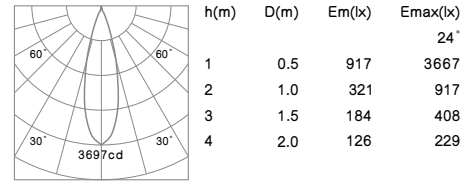
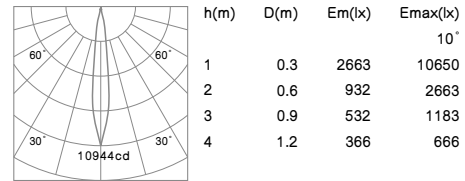

**R6296 15W 1300lm**  
With LED Driver 36V-350mA  
230V-50Hz

NW  
0.69kg

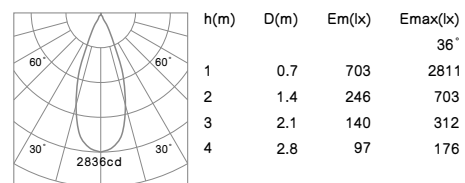
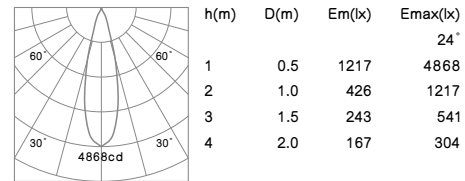
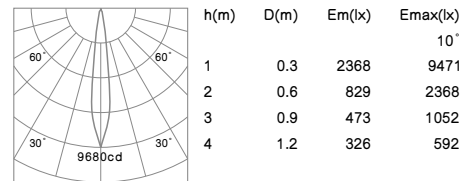

**R6296 20W 1770lm**  
With LED Driver 36V-500mA  
230V-50Hz

NW  
0.69kg

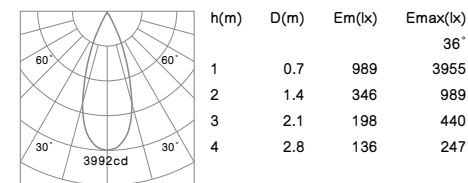
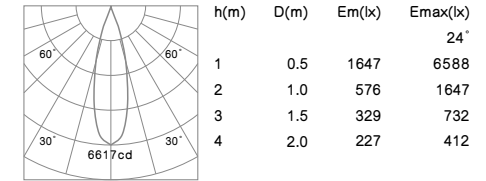
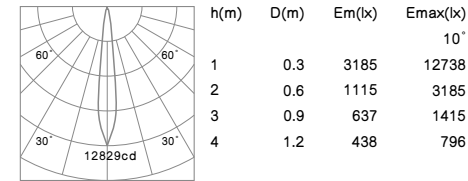

# FOCUS Invisible-fixed



COB LED CRI≥80 IP44 CE RoHS

Reflector color:     
RM RG RD

Color temperature: 2700K 3000K 4000K  
Beam angle: 10° 24° 36°

Driver gear for LED: Non-Dimmable  
1-10V Dimmable  
DALI Dimmable  
Triac Dimmable

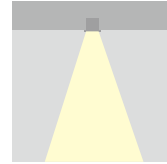

- Die casting process, simple and exquisite appearance, and good heat dissipation performance.
- The new design of narrow edge frame to blend the ceiling perfectly.
- Split structure and the design of frame embedded to avoid ceiling damage during maintenance.
- The reflector structure can make extreme anti-glare and excellent lighting effect.
- Silver mirror, dark chrome, champagne gold, multi-color reflectors can be provided, suitable for various environments.
- IP65 is available.
- UGR≤10.

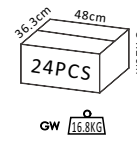
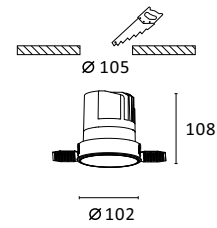

## R6300 6W 560lm With LED Driver 36V-135mA 230V-50Hz

NW  
0.63kg

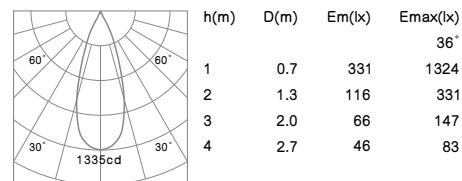
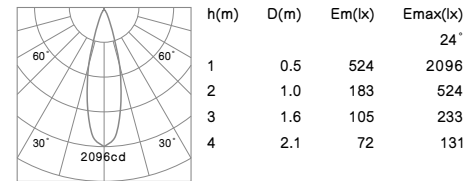
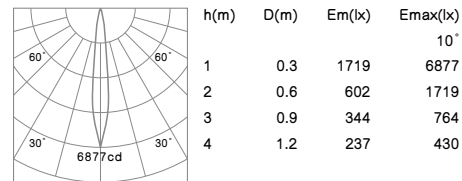

## R6300 10W 970lm With LED Driver 36V-250mA 230V-50Hz

NW  
0.63kg

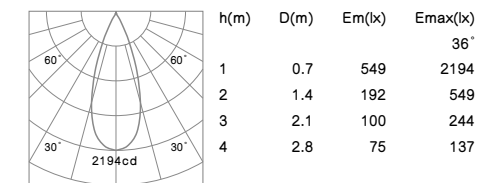
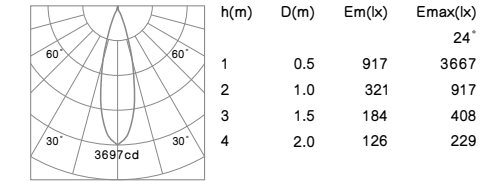
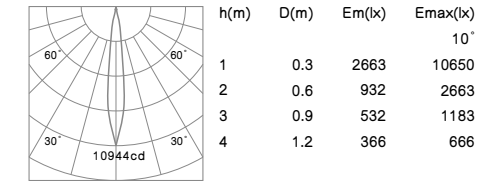

## R6300 15W 1300lm With LED Driver 36V-350mA 230V-50Hz

NW  
0.63kg

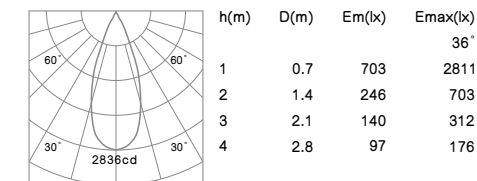
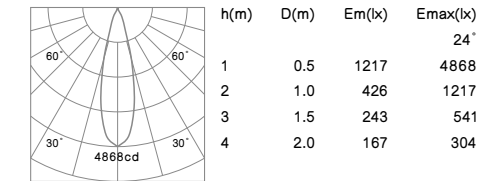
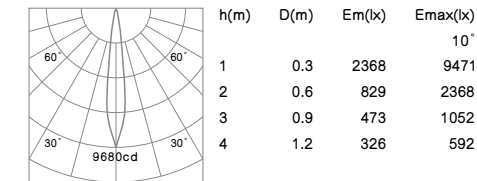



**FOCUS** Invisible-fixed

**R6300 20W 1770lm**  
With LED Driver 36V-500mA  
230V-50Hz

NW  
0.63kg

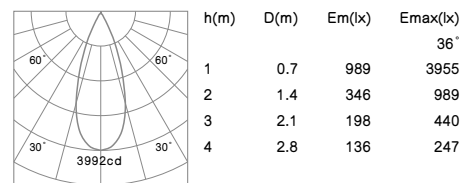
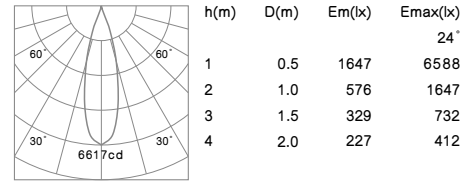
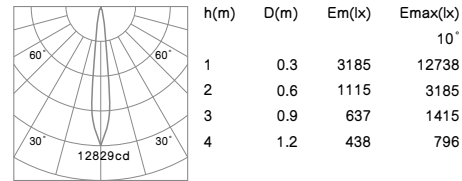

**FOCUS** Invisible-adjustable



**COB LED** **CRI≥80** **IP44** **CE** **RoHS**

Reflector color:     
RM RG RD

Color temperature: 2700K 3000K 4000K  
Beam angle: 10° 24° 36°

Driver gear for LED: Non-Dimmable  
1-10V Dimmable  
DALI Dimmable  
Triac Dimmable

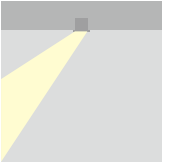

- Die casting process, simple and exquisite appearance, and good heat dissipation performance.
- The new design of narrow edge frame to blend the ceiling perfectly.
- Split structure and the design of frame embedded to avoid ceiling damage during maintenance.
- The reflector structure can make extreme anti-glare and excellent lighting effect.
- Vertical rotation at 30 degrees, horizontal rotation at 355 degrees, suitable for various applications.
- Silver mirror, dark chrome, champagne gold, multi-color reflectors can be provided, suitable for various environments.
- IP65 is available.
- UGR≤10.

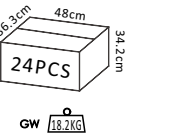
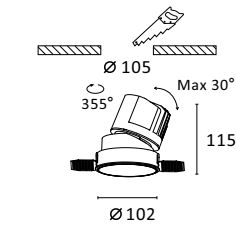

**R6297 6W 560lm**  
With LED Driver 36V-135mA  
230V-50Hz

NW  
0.68kg

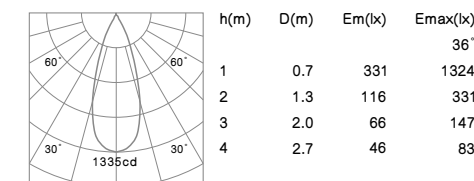
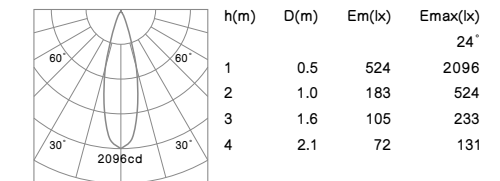
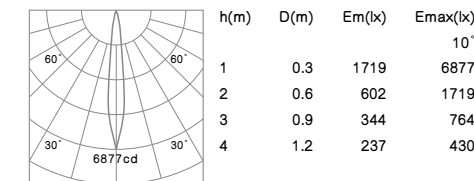

**R6297 10W 970lm**  
With LED Driver 36V-250mA  
230V-50Hz

NW  
0,68kg

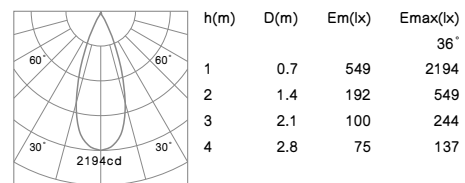
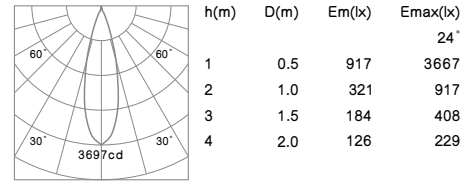
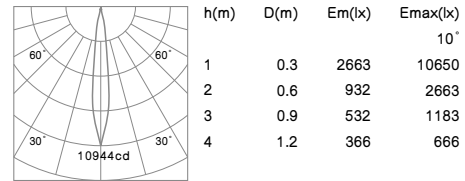

**R6297 15W 1300lm**  
With LED Driver 36V-350mA  
230V-50Hz

NW  
0,68kg

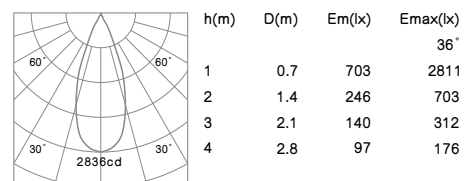
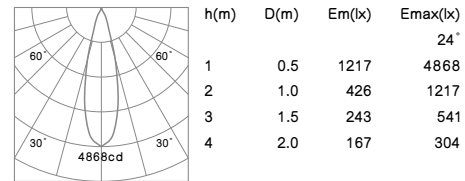
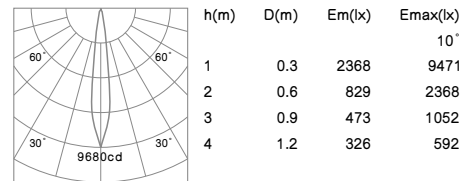

**R6297 20W 1770lm**  
With LED Driver 36V-500mA  
230V-50Hz

NW  
0,68kg

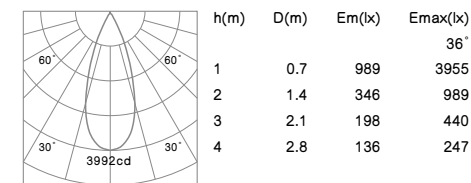
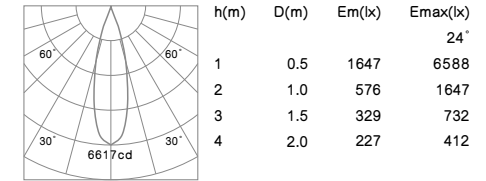
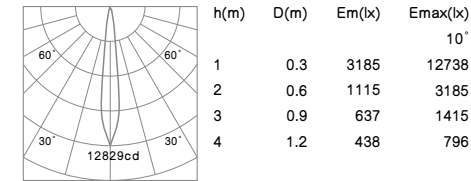

# KAKU

3 kinds of size.

3 kinds of finishing color reflectors for option.  
Rose gold, mirror and dark chrome.



RM (mirror)



RD (dark chrome)



RG (champagne gold)

# KAKU



First, break the spring; plug in the ceiling;  
The springs are automatically fastened to the ceiling.



KAKU

**Reflector Changeable**

The reflector can be changed, even if the light fixture is installed.



Remove the reflector and replace it

045

KAKU

Light Source:  
COB LED with high optical lens.



Installation:  
Spring assembly

The heat sink:  
Efficient laminar and columnar  
array structure.



046

KAKU



047

KAKU

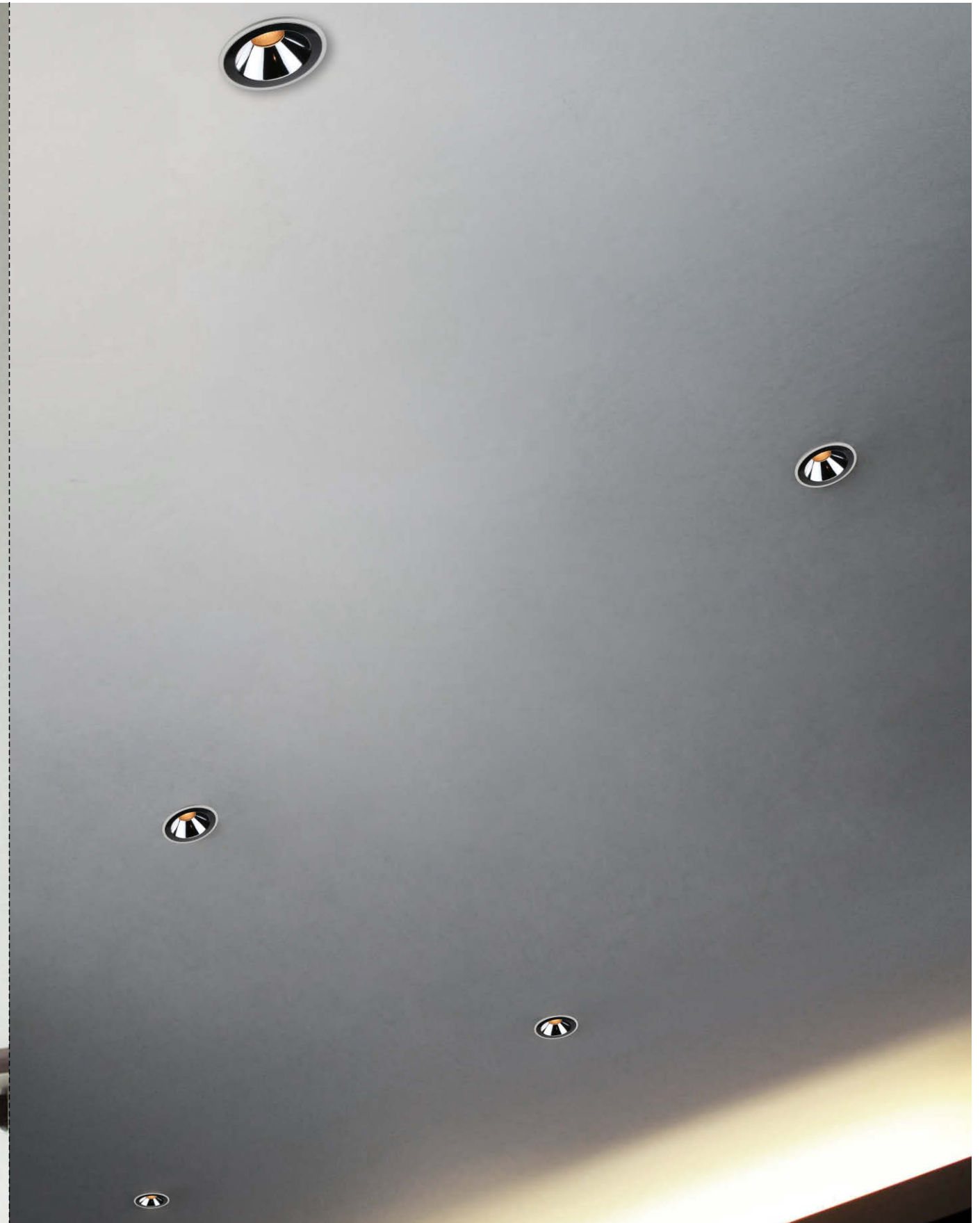

048

# KAKU



## High anti-glare

The reflector:  
Three color options for various applications.

# KAKU



RG (gold)



RM (mirror)

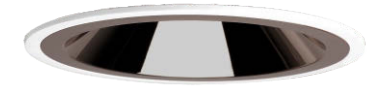

RD (dark chrome)



S Ø 115mm 6W 10W P051



M Ø 115mm 10W 15W P052



L Ø 150mm 15W 20W P053



H Ø 180mm 25W 30W P055



# KAKU



**COB LED CRI≥80 IP44 CE RoHS**

Reflector color:     
 RG RM RD

Mounting frame color: White Silver Black  
 Color temperature: 2700K 3000K 4000K  
 Beam angle: 24° 36° 45°

Driver gear for LED: Non-Dimmable  
 1-10V Dimmable  
 DALI Dimmable  
 Triac Dimmable

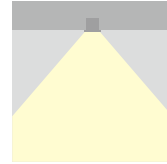

- Housing and Mounting frame: Cast aluminum.
- Light source: COB LED with a lens of optical.
- Reflector: Dark chrome, Mirror finish, champagne-gold to meet different requirements.
- Secondary optics bring the perfect lights effect without more side spot.
- UGR<19.
- The light can be compatible with emergency battery.

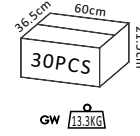
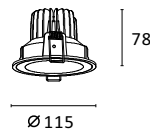
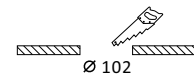

**R6136 6W 570lm**  
 With LED Driver 36V-135mA  
 230V-50Hz

NW  
 0.33kg

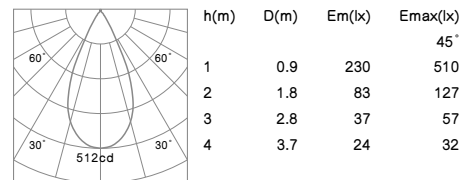
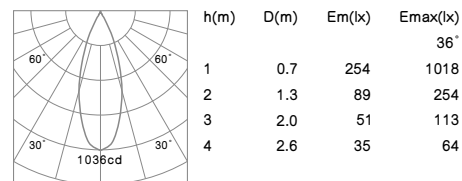
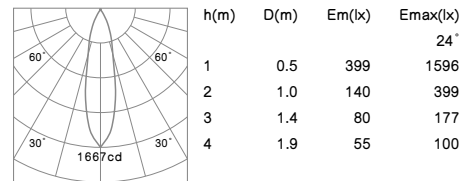

**R6136 10W 710lm**  
 With LED Driver 36V-250mA  
 230V-50Hz

NW  
 0.33kg

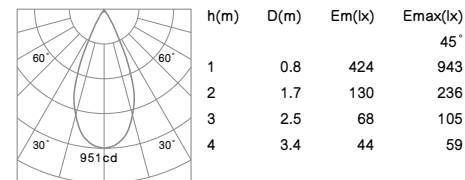
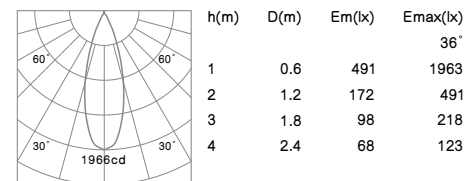
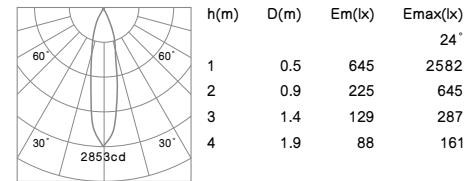

# KAKU



**COB LED CRI≥80 IP44 CE RoHS**

Reflector color:     
 RG RM RD

Mounting frame color: White Silver Black  
 Color temperature: 2700K 3000K 4000K  
 Beam angle: 24° 36° 45°

Driver gear for LED: Non-Dimmable  
 1-10V Dimmable  
 DALI Dimmable  
 Triac Dimmable

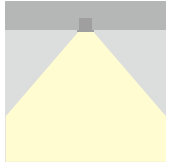

- Housing and Mounting frame: Cast aluminum.
- Light source: COB LED with a lens of optical.
- Reflector: Dark chrome, Mirror finish, champagne-gold to meet different requirements.
- Secondary optics bring the perfect lights effect without more side spot.
- UGR<19.
- The light can be compatible with emergency battery.

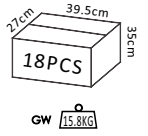
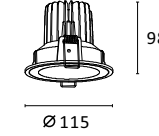
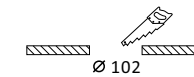

**R6188 10W 710lm**  
 With LED Driver 36V-250mA  
 230V-50Hz

NW  
 0.40kg

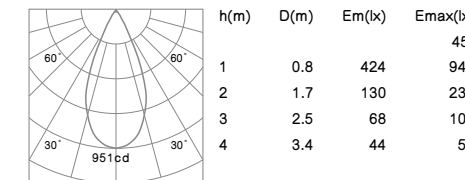
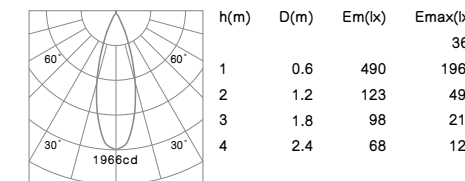
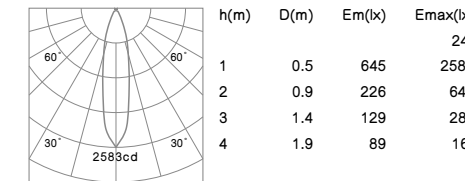

**R6188 15W 930lm**  
 With LED Driver 36V-350mA  
 230V-50Hz

NW  
 0.40kg

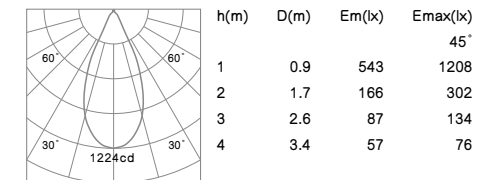
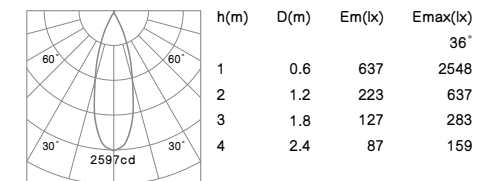
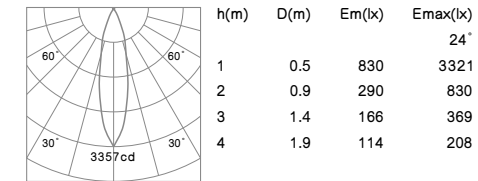

# KAKU



**COB LED CRI≥80 IP44 CE RoHS**

Reflector color:     
RG RM RD

Mounting frame color: White Silver Black  
Color temperature: 2700K 3000K 4000K  
Beam angle: 15° 24° 36°

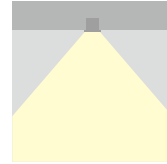

Driver gear for LED: Non-Dimmable  
1-10V Dimmable  
DALI Dimmable  
Triac Dimmable

- Housing and Mounting frame: Cast aluminum.
- Light source: COB LED with a lens of optical.
- Reflector: Dark chrome, Mirror finish, champagne-gold to meet different requirements.
- Secondary optics bring the perfect lights effect without more side spot.
- UGR<19.
- The light can be compatible with emergency battery.

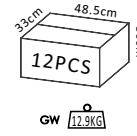
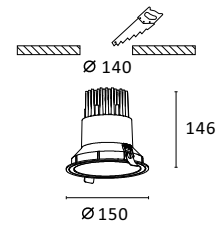

**R6298 15W 1550lm**  
With LED Driver 36V-350mA  
230V-50Hz

NW  
0.89kg

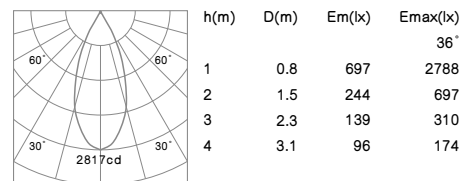
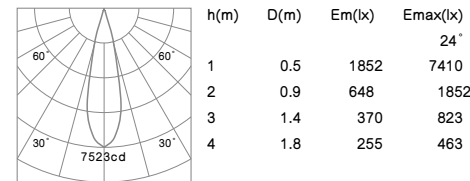
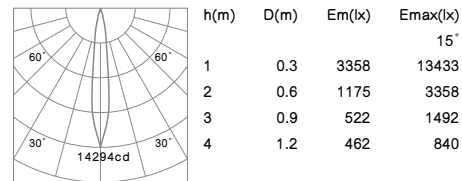

**R6298 20W 2150lm**  
With LED Driver 36V-500mA  
230V-50Hz

NW  
0.89kg

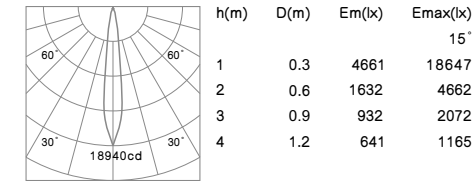

# KAKU

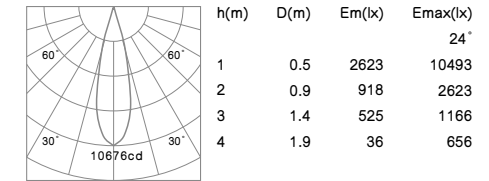
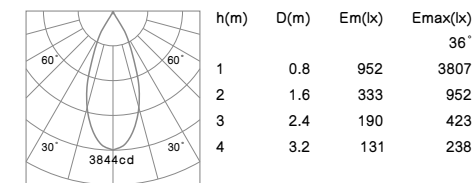

**R6298 25W 2590lm**  
With LED Driver 36V-600mA  
230V-50Hz

NW  
0.89kg

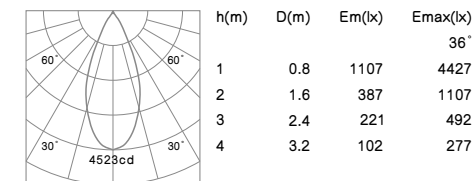
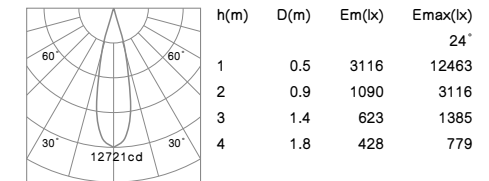
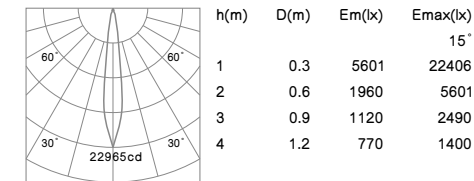

# KAKU



**COB LED CRI≥80 IP44 CE RoHS**

Reflector color:     
 RG RM RD

Mounting frame color: White Silver Black  
 Color temperature: 2700K 3000K 4000K  
 Beam angle: 15° 24° 36°

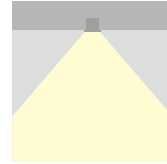

Driver gear for LED: Non-Dimmable  
 1-10V Dimmable  
 DALI Dimmable  
 Triac Dimmable

- Housing and Mounting frame: Cast aluminum.
- Light source: COB LED with a lens of optical.
- Reflector: Dark chrome, Mirror finish, champagne-gold to meet different requirements.
- Secondary optics bring the perfect lights effect without more side spot.
- UGR<19.
- The light can be compatible with emergency battery.

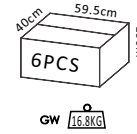
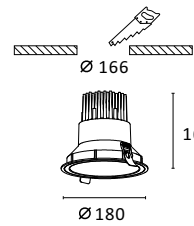

**R6338 25W 2610lm**  
 With LED Driver 36V-600mA  
 230V-50Hz

NW  
 1.10kg

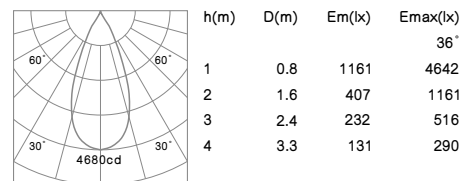
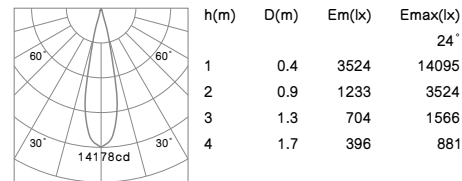
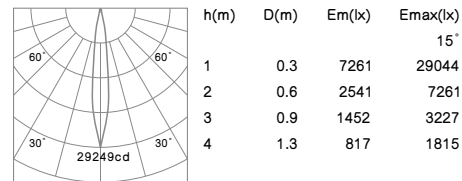

# KAKU

**R6338 30W 3320lm**  
 With LED Driver 36V-800mA  
 230V-50Hz

NW  
 1.10kg

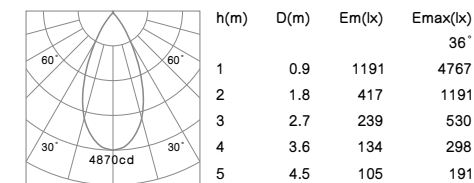
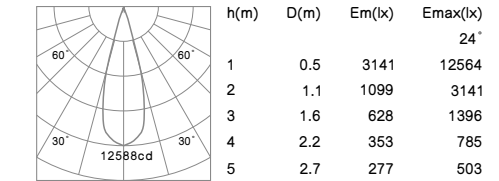
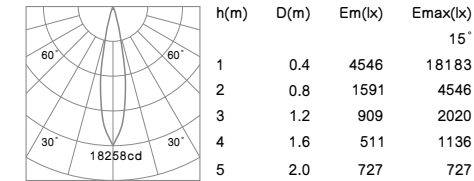

**R6338 40W 4100lm**  
 With LED Driver 36V-1050mA  
 230V-50Hz

NW  
 1.10kg

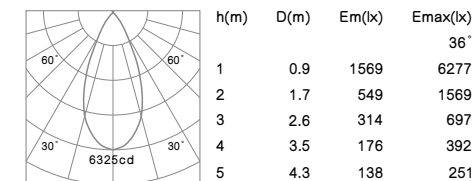
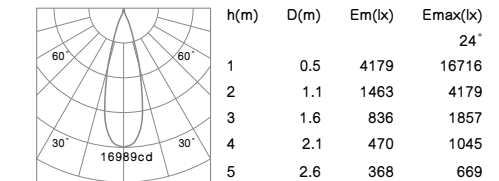
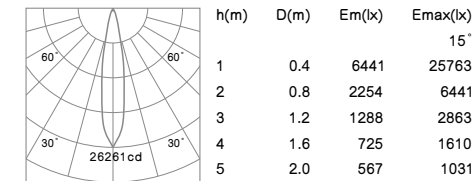



MOBO

Clear / Fogged Diffuser.  
Threaded Anti-dazzle Ring.



057

MOBO



058



Anti-dazzle ring

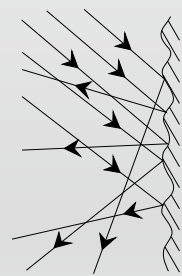

Diffuse

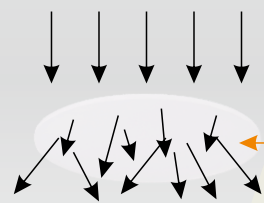

Above two kinds of anti-dazzle design is good to reduce glare, it will be more comfortable for person's eye.





MOBO



MOBO



G (clear glass)



D (fogged diffuser)



M Ø 90mm 6W 10W

P063



P064



L Ø 110mm 15W 20W 25W

P065



P067



H Ø 150mm 25W 30W 40W

P069



P071



# MOBO s



**COB LED CRI≥80 IP44 CE RoHS**  
 Mounting frame color: White Silver Black  
 Color temperature: 2700K 3000K 4000K  
 Beam angle: 45°

Driver gear for LED:  
 Non-Dimmable  
 1-10V Dimmable  
 DALI Dimmable  
 Triac Dimmable

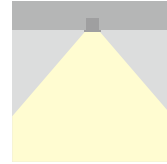

- Housing and Mounting ring: Cast aluminum.
- Light source: COB LED with a high efficiency reflector of optical.
- Anti- dazzling ring: Aluminum black.
- UGR<19.
- The light can be compatible with emergency battery.

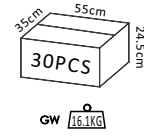
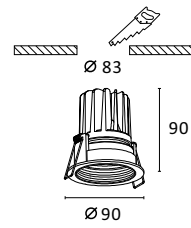

**R6216 6W 530lm**  
 With LED Driver 36V-135mA  
 230V-50Hz

NW  
 0.33kg

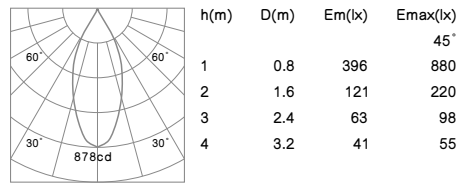

**R6216 10W 920lm**  
 With LED Driver 36V-250mA  
 230V-50Hz

NW  
 0.33kg

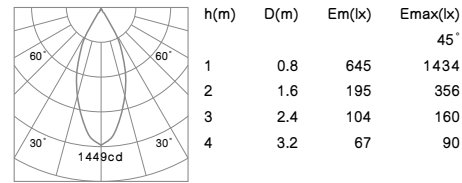

**R6216 15W 1180lm**  
 With LED Driver 36V-350mA  
 230V-50Hz

NW  
 0.33kg

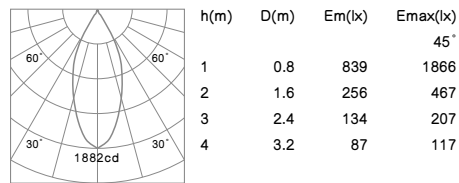

# MOBO s



**COB LED CRI≥80 IP44 CE RoHS**  
 Mounting frame color: White Silver Black  
 Color temperature: 2700K 3000K 4000K  
 Beam angle: 75°

Driver gear for LED:  
 Non-Dimmable  
 1-10V Dimmable  
 DALI Dimmable  
 Triac Dimmable

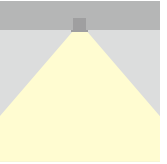

- Housing and Mounting ring: Cast aluminum.
- Light source: COB LED with a high efficiency reflector of optical and a diffuse sheet.
- Anti- dazzling ring: Aluminum black.
- UGR<19.
- The light can be compatible with emergency battery.

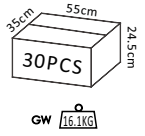
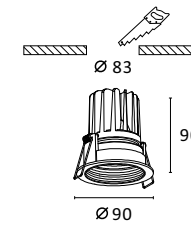

**R6217 6W 350lm**  
 With LED Driver 36V-135mA  
 230V-50Hz

NW  
 0.33kg

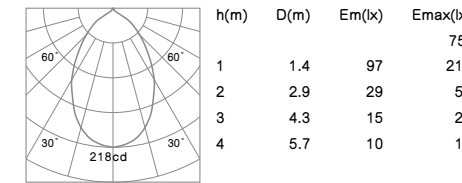

**R6217 10W 610lm**  
 With LED Driver 36V-250mA  
 230V-50Hz

NW  
 0.33kg

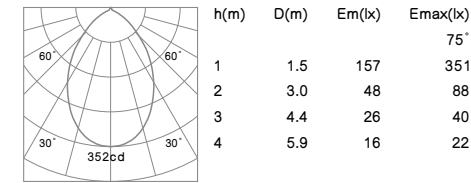

**R6217 15W 790lm**  
 With LED Driver 36V-350mA  
 230V-50Hz

NW  
 0.33kg

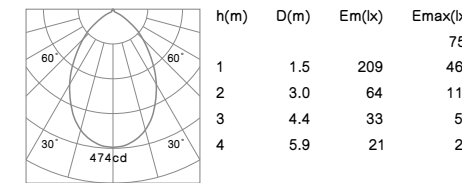

# MOBO M



**COB LED CRI≥80 IP44 CE RoHS**

Mounting frame color: White Silver Black  
 Color temperature: 2700K 3000K 4000K  
 Beam angle: 15° 24° 36° 60°

Driver gear for LED:  
 Non-Dimmable  
 1-10V Dimmable  
 DALI Dimmable  
 Triac Dimmable

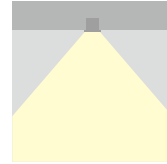

- Housing and Mounting ring: Cast aluminum.
- Light source: COB LED with a high efficiency reflector of optical.
- Anti- dazzling ring: Aluminum black.
- UGR<19.
- The light can be compatible with emergency battery.

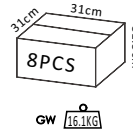
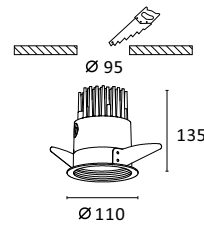

## R6229 15W 1460lm With LED Driver 36V-350mA 230V-50Hz

NW  
0.73kg

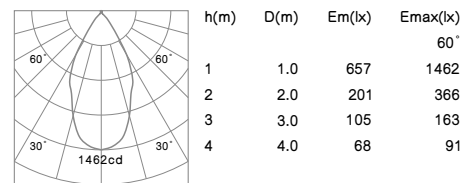
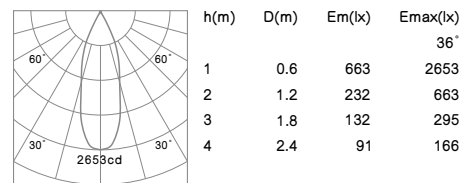
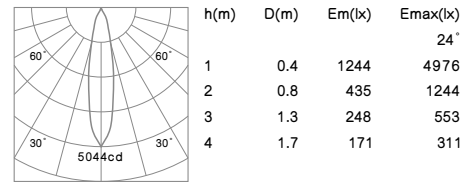
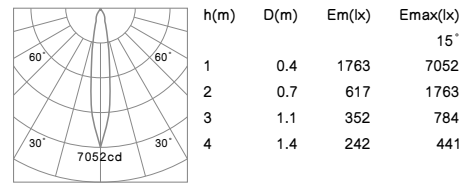

# MOBO M

## R6229 20W 1920lm With LED Driver 36V-500mA 230V-50Hz

NW  
0.73kg

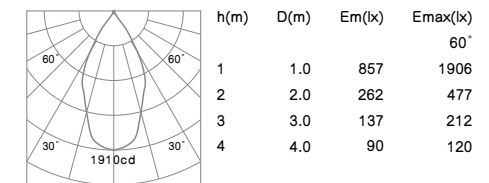
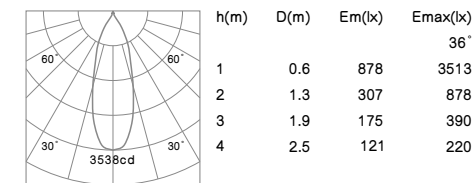
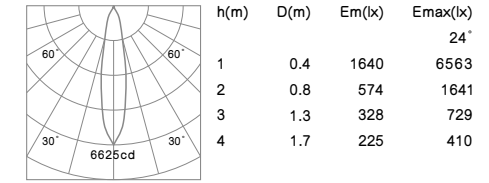
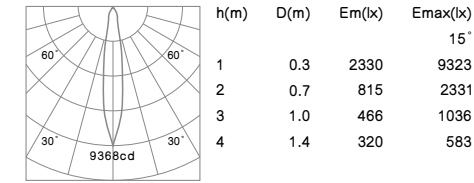

## R6229 25W 2280lm With LED Driver 36V-600mA 230V-50Hz

NW  
0.73kg

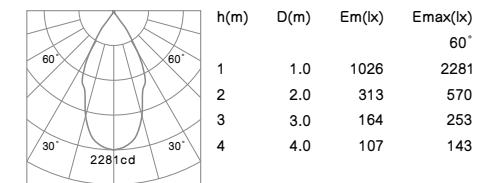
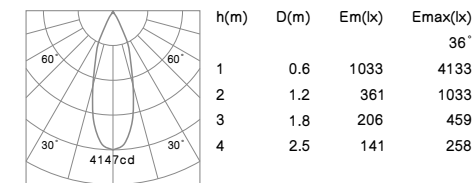
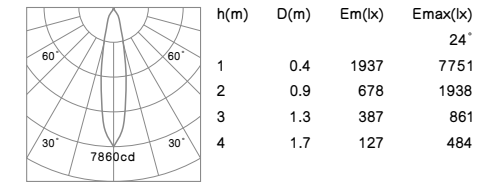
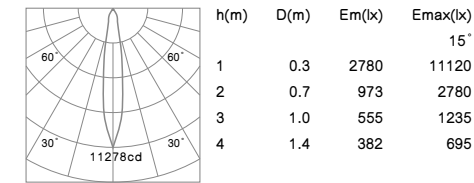

# MOBO M



<b>COB LED</b>	<b>CRI≥80</b>	<b>IP44</b>	<b>CE</b>	<b>RoHS</b>
Mounting frame color:	White	Silver	Black	
Color temperature:	2700K	3000K	4000K	
Beam angle:	45°	60°		

Driver gear for LED:

- Non-Dimmable
- 1-10V Dimmable
- DALI Dimmable
- Triac Dimmable

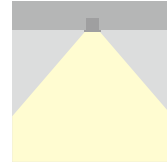

- Housing and Mounting ring: Cast aluminum.
- Light source: COB LED with a high efficiency reflector of optical and a diffuse sheet.
- Anti- dazzling ring: Aluminum black.
- UGR<19.
- The light can be compatible with emergency battery.

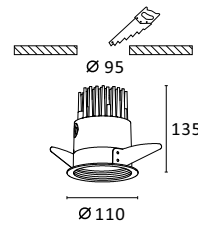

COB LED

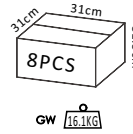

## R6230 15W 1010lm

With LED Driver 36V-350mA  
230V-50Hz

NW  
0.73kg

	h(m)	D(m)	Em(lx)	Emax(lx)
				45°
				60°
1	1.1	193	774	
2	2.2	67	193	
3	3.3	38	86	
4	4.3	26	49	

	h(m)	D(m)	Em(lx)	Emax(lx)
				60°
1	1.1	183	732	
2	2.3	64	183	
3	3.4	36	81	
4	4.6	25	46	

# MOBO M

## R6230 20W 1330lm

With LED Driver 36V-500mA  
230V-50Hz

NW  
0.73kg

	h(m)	D(m)	Em(lx)	Emax(lx)
				45°
1	1.1	255	1020	
2	2.2	89	255	
3	3.2	50	113	
4	4.2	35	64	

	h(m)	D(m)	Em(lx)	Emax(lx)
				60°
1	1.1	241	964	
2	2.3	84	241	
3	3.4	48	108	
4	4.6	33	60	

## R6230 25W 1590lm

With LED Driver 36V-600mA  
230V-50Hz

NW  
0.73kg

	h(m)	D(m)	Em(lx)	Emax(lx)
				45°
1	1.1	300	1202	
2	2.2	105	301	
3	3.3	60	134	
4	4.3	41	75	

	h(m)	D(m)	Em(lx)	Emax(lx)
				60°
1	1.1	285	1141	
2	2.3	99	285	
3	3.4	57	127	
4	4.5	39	71	



# MOBO L



**COB LED CRI≥80 IP44 CE RoHS**

Mounting frame color: White Silver Black  
 Color temperature: 2700K 3000K 4000K  
 Beam angle: 15° 24° 36° 60°

Driver gear for LED:  
 Non-Dimmable  
 1-10V Dimmable  
 DALI Dimmable  
 Triac Dimmable

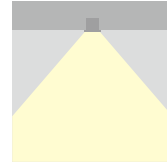

- Housing and Mounting ring: Cast aluminum.
- Light source: COB LED with a high efficiency reflector of optical.
- Anti- dazzling ring: Aluminum black.
- UGR<19.
- The light can be compatible with emergency battery.

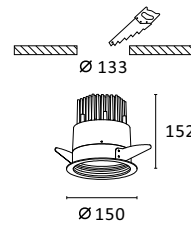

COB LED

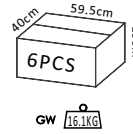

## R6286 25W 2570lm With LED Driver 36V-600mA 230V-50Hz

NW  
1.07kg

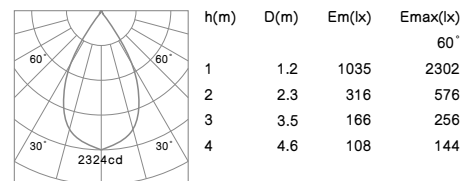
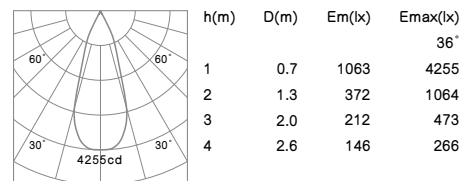
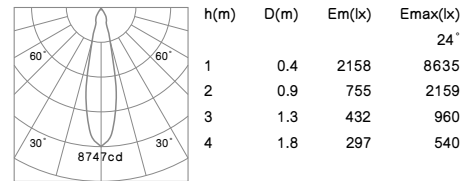
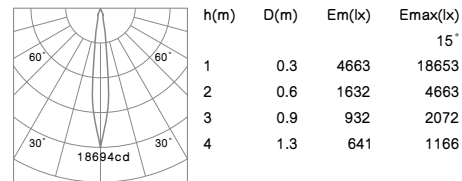

# MOBO L

## R6286 30W 3000lm With LED Driver 36V-800mA 230V-50Hz

NW  
1.07kg

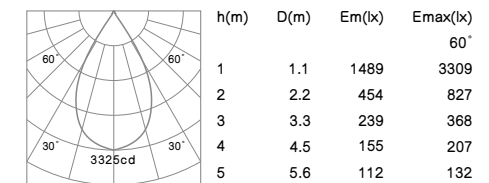
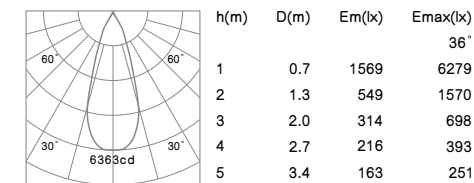
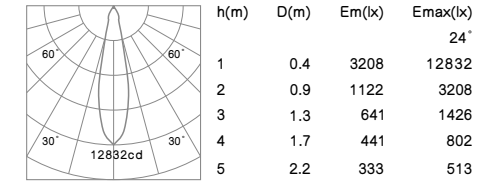
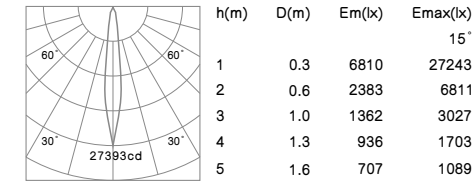

## R6286 40W 3980lm With LED Driver 36V-1050mA 230V-50Hz

NW  
1.07kg

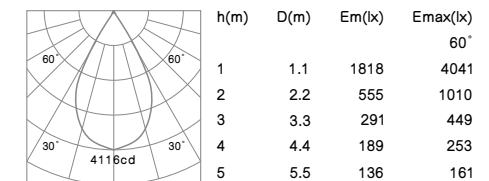
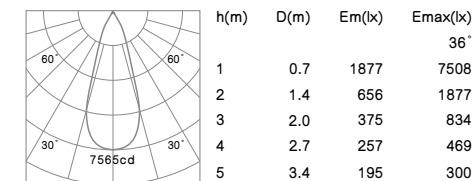
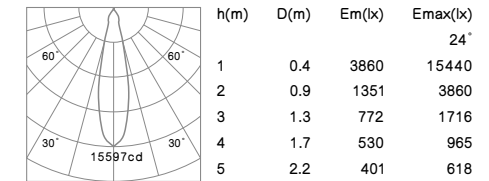
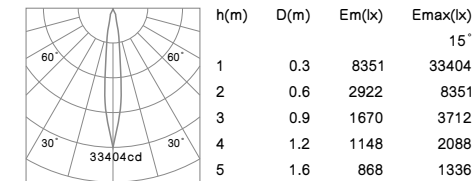

# MOBO L



**COB LED CRI≥80 IP44 CE RoHS**

Mounting frame color: White Silver Black  
 Color temperature: 2700K 3000K 4000K  
 Beam angle: 60° 70°

Driver gear for LED:  
 Non-Dimmable  
 1-10V Dimmable  
 DALI Dimmable  
 Triac Dimmable

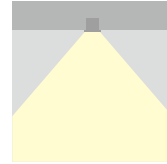

- Housing and Mounting ring: Cast aluminum.
- Light source: COB LED with a high efficiency reflector of optical and a diffuse sheet.
- Anti- dazzling ring: Aluminum black.
- UGR<19.
- The light can be compatible with emergency battery.

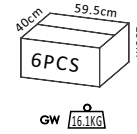
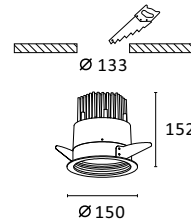

**R6287 25W 1780lm**  
 With LED Driver 36V-600mA  
 230V-50Hz

NW  
 1.07kg

h(m)	D(m)	Em(lx)	Emax(lx)
1	1.3	280	1121
2	2.5	98	280
3	3.8	56	125
4	5.1	38	70

h(m)	D(m)	Em(lx)	Emax(lx)
1	1.4	427	950
2	2.8	130	237
3	4.2	68	106
4	5.7	44	59

# MOBO L

**R6287 30W 2580lm**  
 With LED Driver 36V-800mA  
 230V-50Hz

NW  
 1.07kg

h(m)	D(m)	Em(lx)	Emax(lx)
1	1.3	404	1618
2	2.5	141	405
3	3.8	81	180
4	5.1	55	101
5	6.3	42	65

h(m)	D(m)	Em(lx)	Emax(lx)
1	1.4	637	1416
2	2.8	194	354
3	4.3	102	157
4	5.7	66	89
4	7.1	48	57

**R6287 40W 3090lm**  
 With LED Driver 36V-1050mA  
 230V-50Hz

NW  
 1.07kg

h(m)	D(m)	Em(lx)	Emax(lx)
1	1.3	494	1976
2	2.5	172	494
3	3.8	99	220
4	5.1	68	124
5	6.3	51	79

h(m)	D(m)	Em(lx)	Emax(lx)
1	1.3	760	1691
2	2.8	232	423
3	4.3	122	188
4	5.7	79	106
5	7.1	57	68

DEEP AUDA

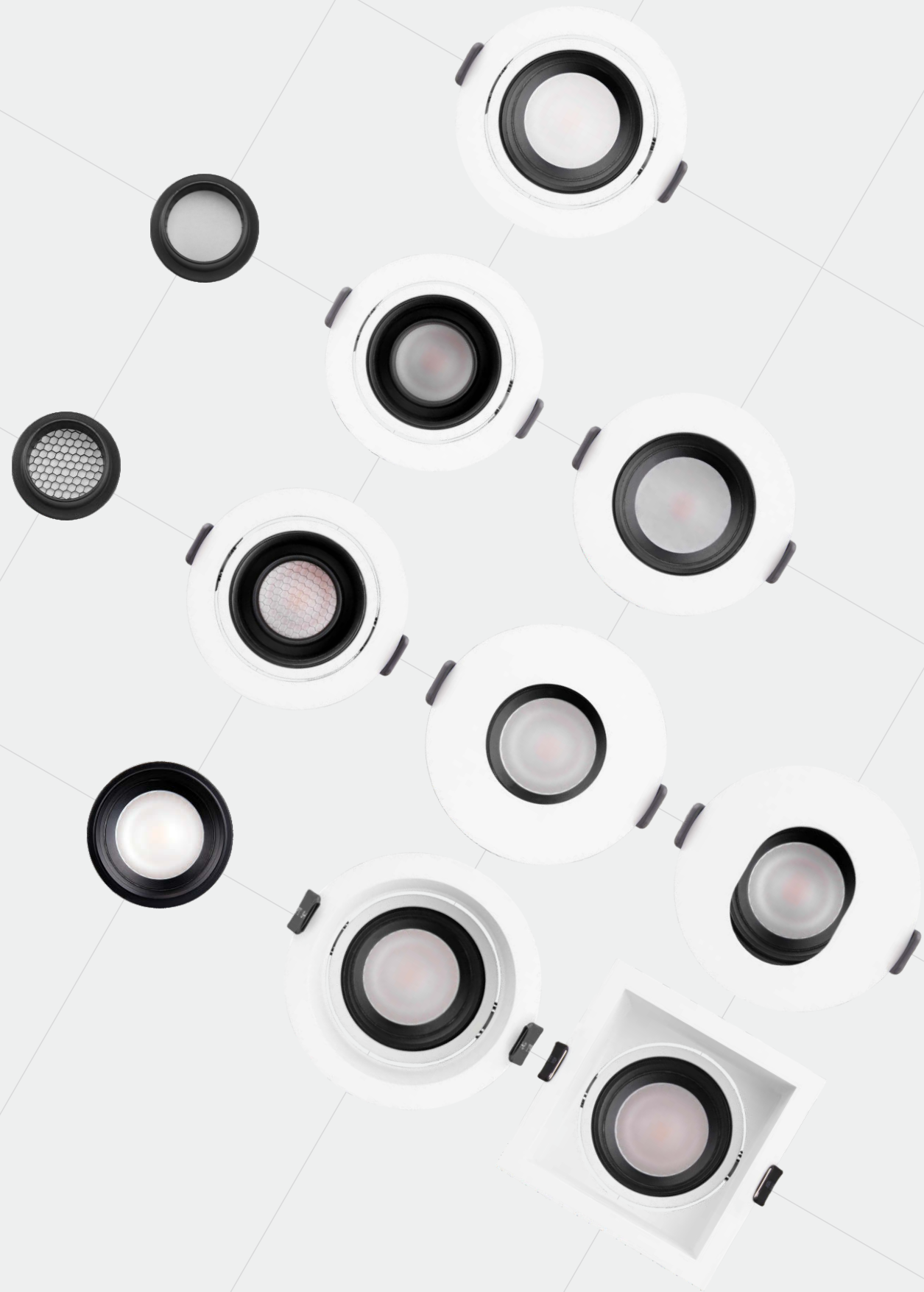

073

DEEP AUDA

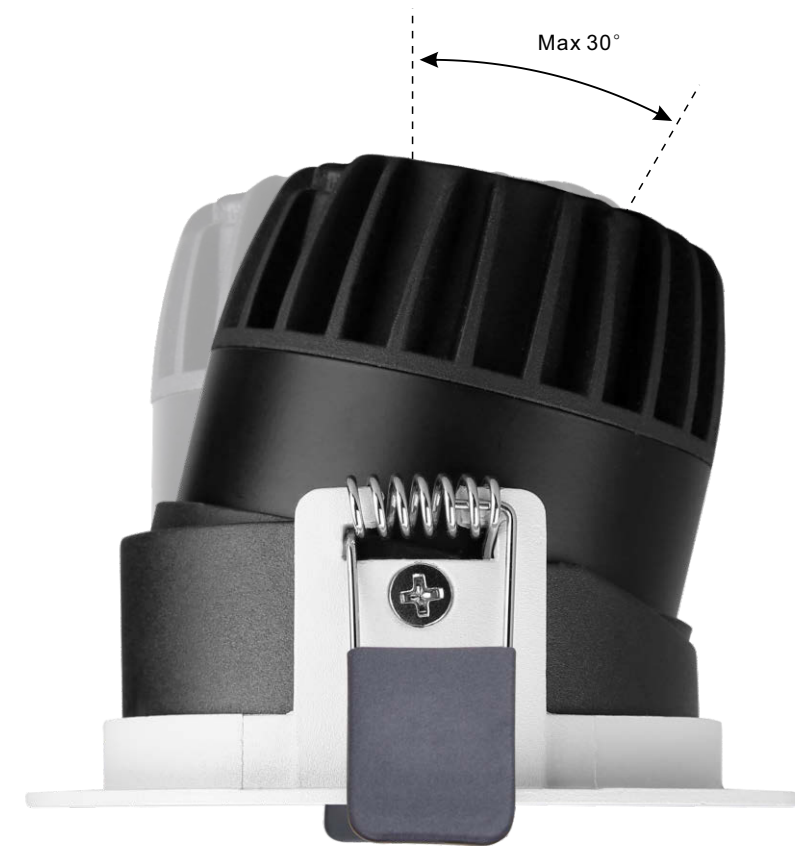

### Adjustable Direction Design

The spot light tilts to a maximum of  $0^{\circ}$  -  $30^{\circ}$  onto the vertical plane.  
The lighting angle and direction can be adjusted according to the scene used.

074



DEEP AUDA

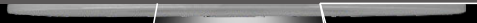
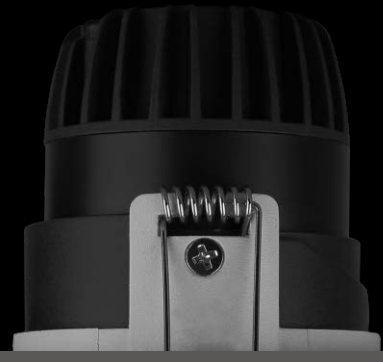

075

DEEP AUDA

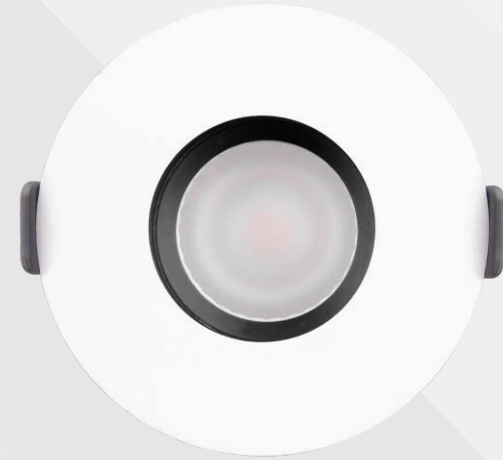

**Pin-hole frame**

Pin-hole frame can improve the anti-dazzle effect of lamps.

076



DEEP AUDA



Anti-Dazzle Snoot and Honey Comb



15055  
Snoot

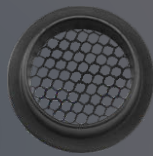

03141  
Honey comb

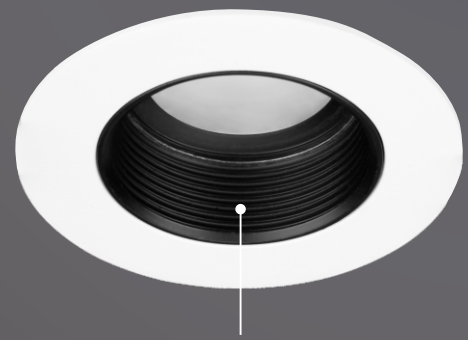

Anti-Dazzle Ring

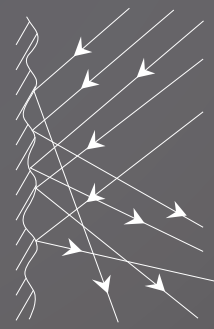

Principle







DEEP AUDA



081

DEEP AUDA



Ø 87mm 6W 10W

P083



Ø 90mm 6W 10W

P085



Ø 90mm 6W 10W

P087



Ø 90mm 6W 10W

P089



Ø 90mm 6W 10W

P091



□ 90x90mm 6W 10W

P093



Ø 100mm 6W 10W 15W

P095

082

# DEEP AUDA



**COB LED CRI≥80 IP44 CE RoHS**  
 Mounting frame color: White Silver Black  
 Color temperature: 2700K 3000K 4000K  
 Beam angle: 10° 24° 36° 60°

Driver gear for LED:  
 Non-Dimmable  
 1-10V Dimmable  
 DALI Dimmable  
 Triac Dimmable

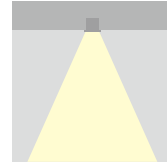

- Housing and Mounting ring: Cast aluminum.
- Light source: COB LED with a lens of optical.
- Anti- dazzling ring: Aluminum black.
- Accessories: Anti-Glare Snoot and honey comb is optional.
- UGR<19.
- The light can be compatible with emergency battery.

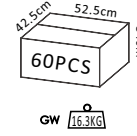
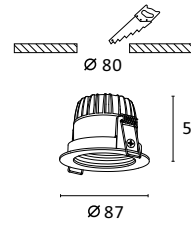

**R6900 6W 390lm**  
 With LED Driver 36V-135mA  
 230V-50Hz

NW  
 0.27kg

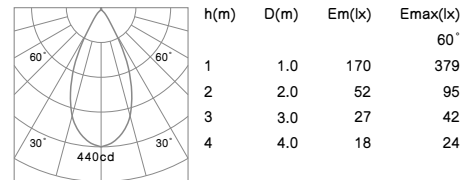
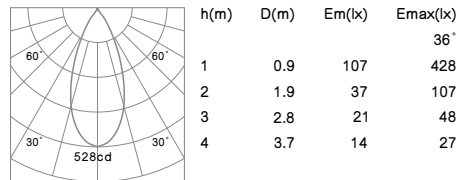
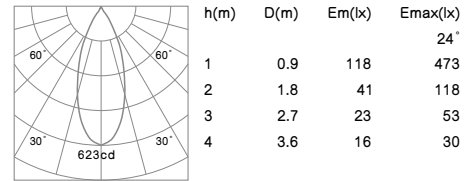
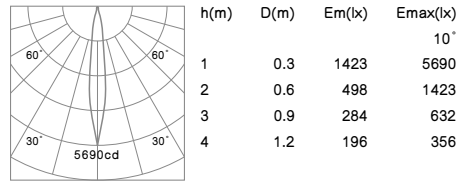

# DEEP AUDA

**R6900 10W 690lm**  
 With LED Driver 36V-250mA  
 230V-50Hz

NW  
 0.27kg

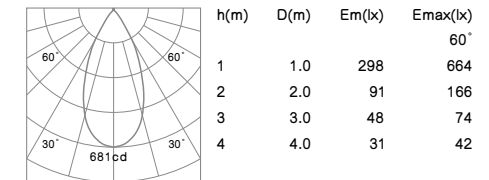
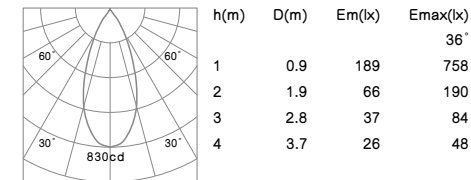
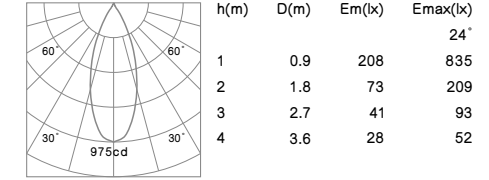
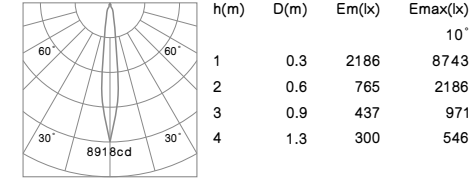

## Optical Accessories :



**03141**

Honey comb for above COB LED recessed down lights.



**15055**

Snoot for above COB LED recessed down lights.

# DEEP AUDA



**COB LED CRI≥80 IP44 CE RoHS**

Mounting frame color: White Silver Black  
 Color temperature: 2700K 3000K 4000K  
 Beam angle: 10° 24° 36° 60°

Driver gear for LED:  
 Non-Dimmable  
 1-10V Dimmable  
 DALI Dimmable  
 Triac Dimmable

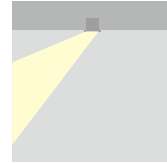

- Housing and Mounting ring: Cast aluminum.
- The spot light tilts to a maximum of 0-30° onto the vertical plane.
- Light source: COB LED with a high efficiency reflector of optical
- Anti-dazzling ring: Aluminum black.
- Accessories: Anti-Glare Snoot and honey comb is optional.
- UGR<19.
- The light can be compatible with emergency battery.

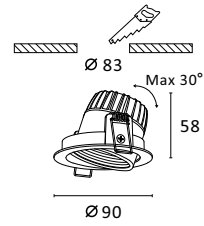

COB LED

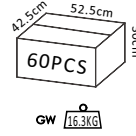

**R6901 6W 390lm**  
 With LED Driver 36V-135mA  
 230V-50Hz

NW  
 0.27kg

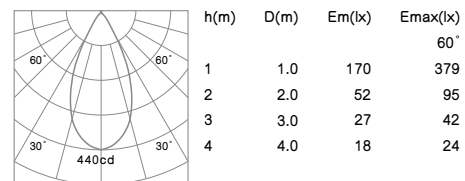
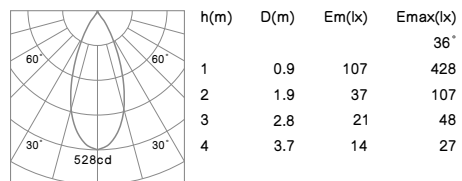
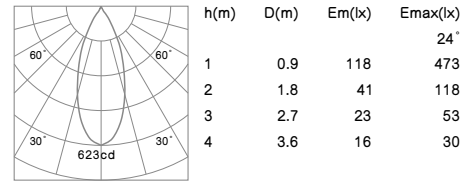
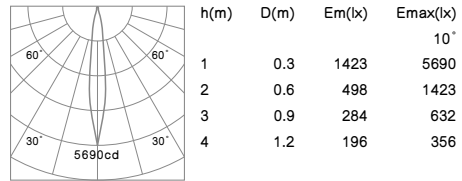

# DEEP AUDA

**R6901 10W 690lm**  
 With LED Driver 36V-250mA  
 230V-50Hz

NW  
 0.27kg

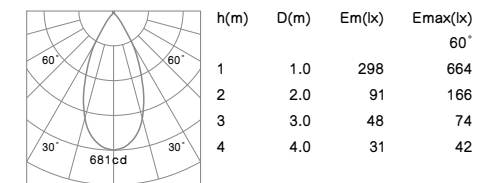
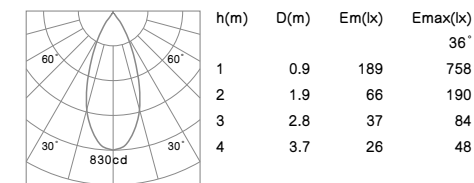
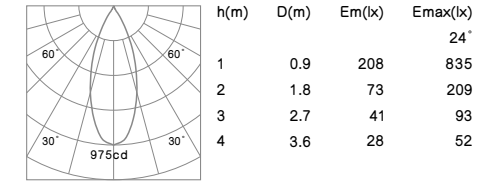
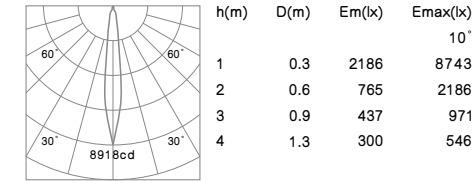

## Optical Accessories:



**03141**

Honey comb for above COB LED recessed spot lights.



**15055**

Snoot for above COB LED recessed spot lights.

# DEEP AUDA



**COB LED CRI≥80 IP44 CE RoHS**

Mounting frame color: White Silver Black  
 Color temperature: 2700K 3000K 4000K  
 Beam angle: 10° 24° 36° 60°

Driver gear for LED:  
 Non-Dimmable  
 1-10V Dimmable  
 DALI Dimmable  
 Triac Dimmable

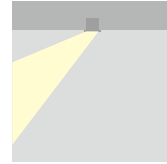

- Housing and Mounting ring: Cast aluminum.
- The spot light tilts to a maximum of 0-30° onto the vertical plane.
- Light source: COB LED with a high efficiency reflector of optical
- Anti- dazzling ring: Aluminum black.
- UGR<19.
- The light can be compatible with emergency battery.

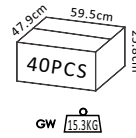
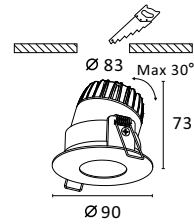

**R6904 6W 230lm**  
 With LED Driver 36V-135mA  
 230V-50Hz

NW  
 0.30kg

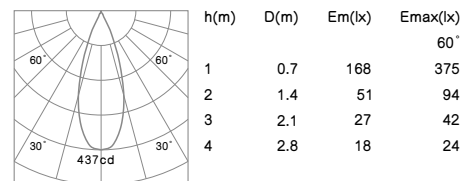
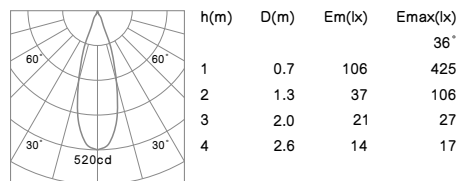
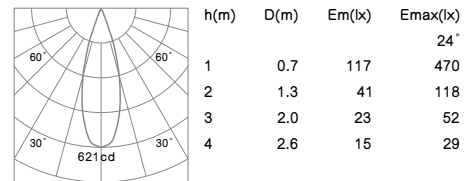
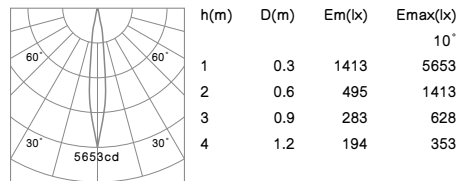

# DEEP AUDA

**R6904 10W 420lm**  
 With LED Driver 36V-250mA  
 230V-50Hz

NW  
 0.30kg

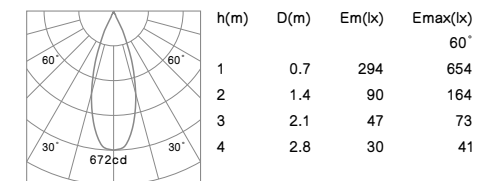
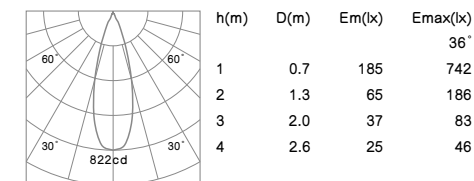
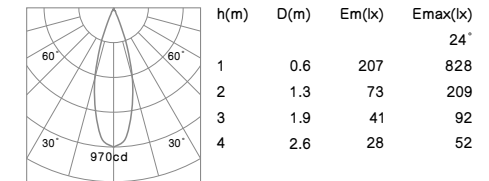
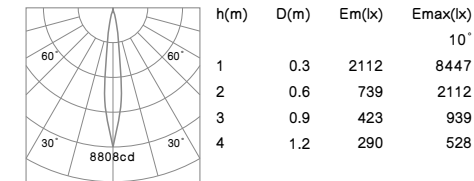



# DEEP AUDA



**COB LED CRI≥80 IP44 CE RoHS**

Mounting frame color: White Silver Black  
 Color temperature: 2700K 3000K 4000K  
 Beam angle: 10° 24° 36° 60°

Driver gear for LED:  
 Non-Dimmable  
 1-10V Dimmable  
 DALI Dimmable  
 Triac Dimmable

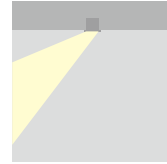

- Housing and Mounting ring: Cast aluminum.
- The spot light tilts to a maximum of 0-30° onto the vertical plane.
- Light source: COB LED with a high efficiency reflector of optical
- Anti-dazzling ring: Aluminum black.
- UGR<19.
- The light can be compatible with emergency battery.

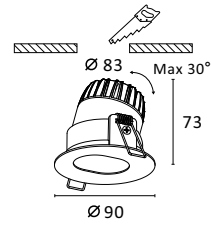

COB LED

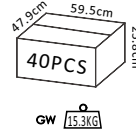

## R6905 6W 250lm With LED Driver 36V-135mA 230V-50Hz

NW  
0.30kg

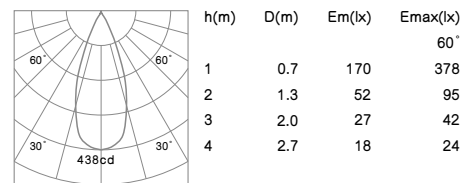
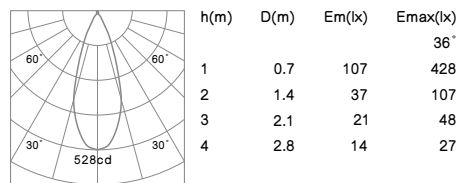
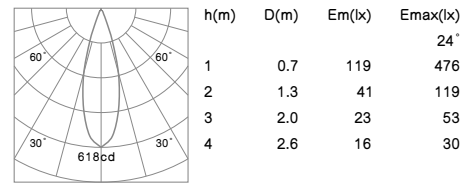
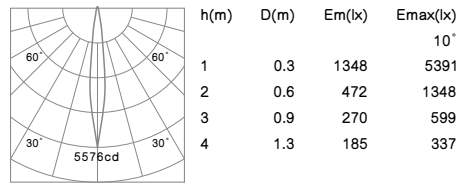

# DEEP AUDA

## R6905 10W 450lm With LED Driver 36V-250mA 230V-50Hz

NW  
0.30kg

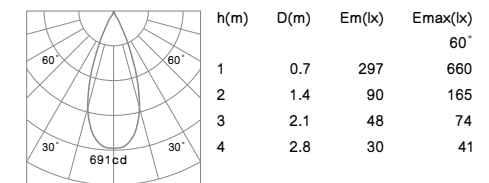
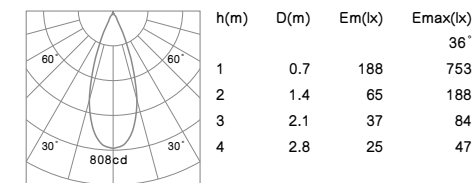
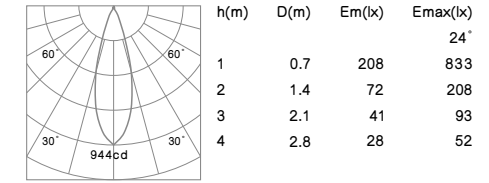
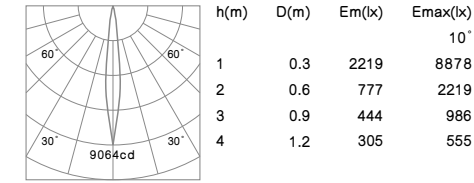

# DEEP AUDA



**COB LED CRI≥80 IP44 CE RoHS**

Mounting frame color: White Silver Black  
 Color temperature: 2700K 3000K 4000K  
 Beam angle: 10° 24° 36° 60°

Driver gear for LED:  
 Non-Dimmable  
 1-10V Dimmable  
 DALI Dimmable  
 Triac Dimmable

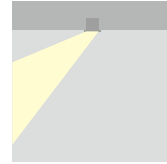

- Housing and Mounting ring: Cast aluminum.
- The spot light tilts to a maximum of 0-30° onto the vertical plane.
- Light source: COB LED with a high efficiency reflector of optical
- Anti- dazzling ring: Aluminum black.
- Accessories: Anti-Glare Snoot and honey comb is optional.
- UGR<19.
- The light can be compatible with emergency battery.

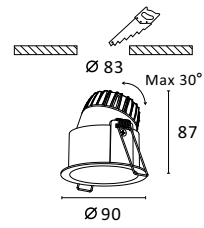

COB LED

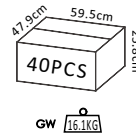

**R6902 6W 350lm**  
 With LED Driver 36V-135mA  
 230V-50Hz

NW  
 0.32kg

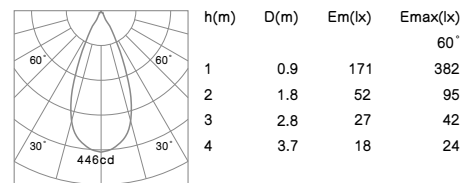
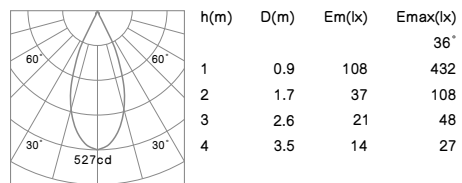
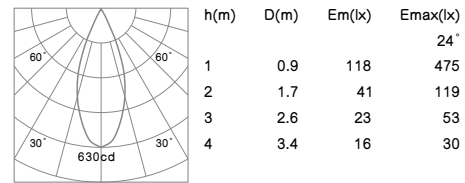
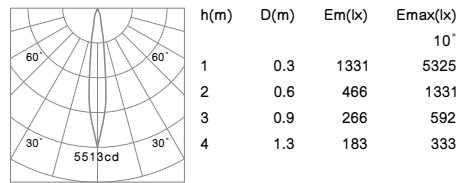

# DEEP AUDA

**R6902 10W 600lm**  
 With LED Driver 36V-250mA  
 230V-50Hz

NW  
 0.32kg

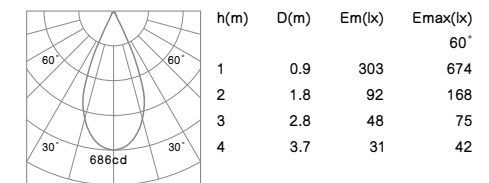
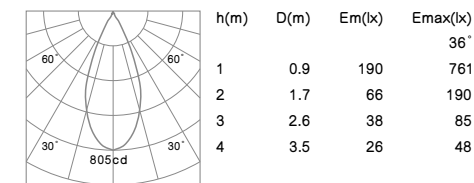
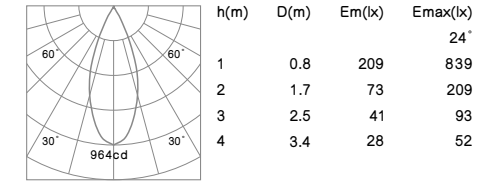
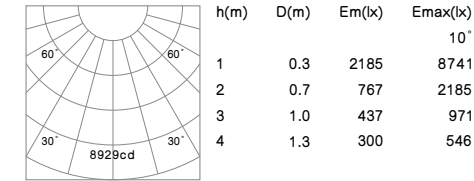

## Optical Accessories :



**03141**

Honey comb for above COB LED recessed spot lights.



**15055**

Snoot for above COB LED recessed spot lights.

# DEEP AUDA



**COB LED** **CRI≥80** **IP44** **CE** **RoHS**

Mounting frame color: White Silver Black  
 Color temperature: 2700K 3000K 4000K  
 Beam angle: 10° 24° 36° 60°

Driver gear for LED:  
 Non-Dimmable  
 1-10V Dimmable  
 DALI Dimmable  
 Triac Dimmable

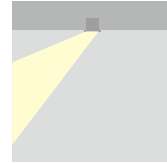

- Housing and Mounting ring: Cast aluminum.
- The spot light tilts to a maximum of 0-30° onto the vertical plane.
- Light source: COB LED with a high efficiency reflector of optical
- Anti- dazzling ring: Aluminum black.
- Accessories: Anti-Glare Snoot and honey comb is optional.
- UGR<19.
- The light can be compatible with emergency battery.

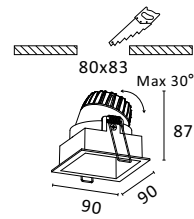

COB LED

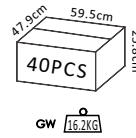

**R6903 6W 360lm**  
 With LED Driver 36V-135mA  
 230V-50Hz

NW  
 0.32kg

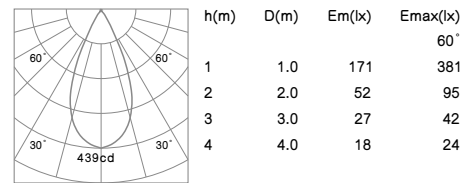
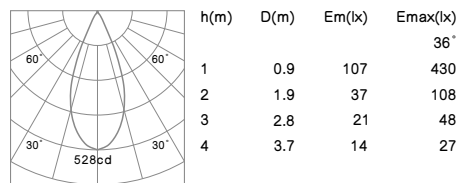
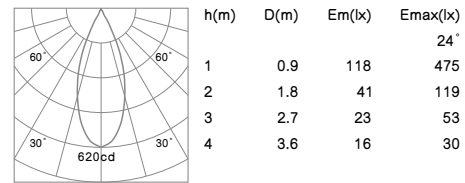
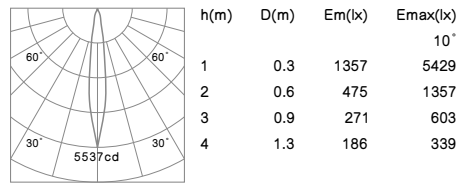

# DEEP AUDA

**R6903 10W 640lm**  
 With LED Driver 36V-250mA  
 230V-50Hz

NW  
 0.32kg

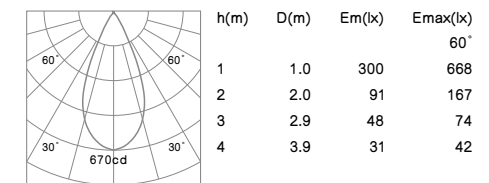
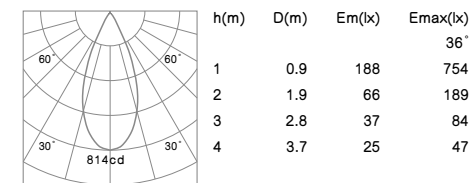
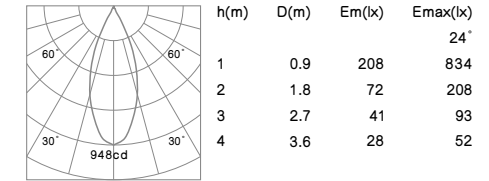
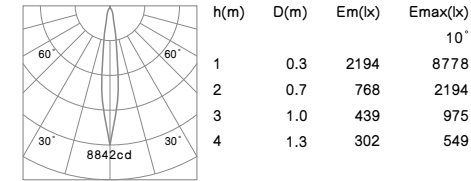

## Optical Accessories :



**03141**

Honey comb for above COB LED recessed spot lights.



**15055**

Snoot for above COB LED recessed spot lights.



# ROSU



**COB LED CRI≥80 IP44 CE RoHS**  
 Mounting frame color: White Silver Black  
 Color temperature: 2700K 3000K 4000K  
 Beam angle: 24° 36°

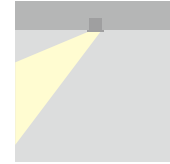

Driver gear for LED:  
 Non-Dimmable  
 1-10V Dimmable  
 DALI Dimmable  
 Triac Dimmable

- Housing: Cast aluminum.
- The spot light tilts to a maximum of 0°-30° onto the vertical plane and rotates by 358° onto the horizontal plane.
- Light source: COB LED with a lens of optical.
- Anti-dazzle ring: Aluminum black.
- The light can be compatible with emergency battery.

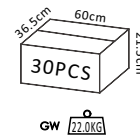
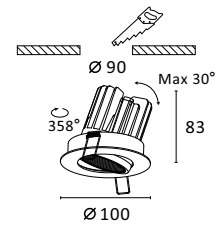

**R6262 6W 573lm**  
 With LED Driver 36V-135mA  
 230V-50Hz

NW  
 0.36kg

h(m)	D(m)	Em(lx)	Emax(lx)
1	0.5	479	1915
2	0.9	168	479
3	1.4	96	213
4	1.8	66	120

h(m)	D(m)	Em(lx)	Emax(lx)
1	0.6	335	1338
2	1.2	117	335
3	1.8	67	149
4	2.4	46	84

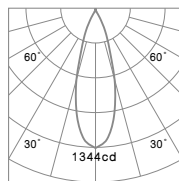

# ROSU

**R6262 10W 1012lm**  
 With LED Driver 36V-250mA  
 230V-50Hz

NW  
 0.36kg

h(m)	D(m)	Em(lx)	Emax(lx)
1	0.5	642	2567
2	0.9	225	642
3	1.4	28	285
4	1.8	89	161

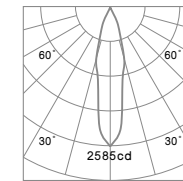

h(m)	D(m)	Em(lx)	Emax(lx)
1	0.6	489	1955
2	1.2	171	489
3	1.7	98	217
4	2.3	67	122

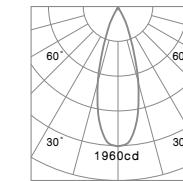

**R6262 15W 1302lm**  
 With LED Driver 36V-350mA  
 230V-50Hz

NW  
 0.36kg

h(m)	D(m)	Em(lx)	Emax(lx)
1	0.4	955	3821
2	0.9	334	955
3	1.3	191	425
4	1.8	131	239
5	2.2	99	153

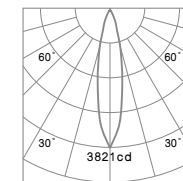

h(m)	D(m)	Em(lx)	Emax(lx)
1	0.5	714	2854
2	1.1	250	714
3	1.6	143	317
4	2.1	98	178
5	2.7	74	114

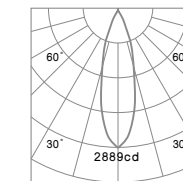

AUDA



097

AUDA



**3** COB  
LED  
Specifications



**6W**

36V-135mA



**10W**

36V-250mA

**15W**

36V-350mA

098

# AUDA

FACE

6W/10W

15W

CHARACTERISTICS



Fixed

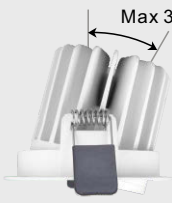
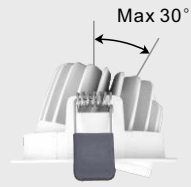

Adjustable: Max 30°

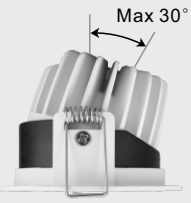
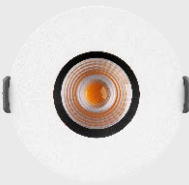

Adjustable: Max 30°  
Anti-Dazzle: A Circular Pin-hole

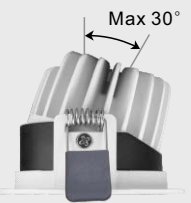
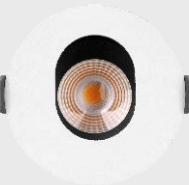

Adjustable: Max 30°  
Anti-Dazzle: An Elliptical Pin-hole

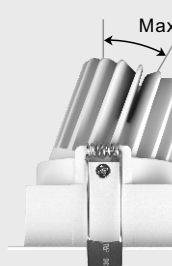

Adjustable: Max 30°  
Anti-Dazzle: Deep Square Frame



Adjustable: Max 30°  
Anti-Dazzle: Deep round Frame

# AUDA









# AUDA



Ø 82mm

6W 10W

P105



Ø 90mm

6W 10W

P106



Ø 90mm

6W 10W

P107



Ø 90mm

6W 10W

P108



Ø 90mm

6W 10W

P109



□ 90x90mm

6W 10W

P110

# AUDA



Ø 82mm

15W

P111



Ø 90mm

15W

P112



Ø 90mm

15W

P113



Ø 90mm

15W

P114



Ø 90mm

15W

P115



□ 90x90mm

15W

P116

# AUDA



**COB LED CRI≥80 IP44 CE RoHS**

Mounting frame color: White Silver Black  
 Color temperature: 2700K 3000K 4000K  
 Beam angle: 24° 36° 60°

Driver gear for LED: Non-Dimmable  
 1-10V Dimmable  
 DALI Dimmable  
 Triac Dimmable



- Housing and Mounting ring: Cast aluminum.
- Light source: COB LED with a lens of optical.

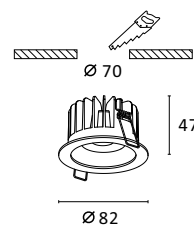

COB LED

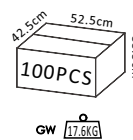

**R6153 6W 700lm**  
 With LED Driver 36V-135mA  
 230V-50Hz

NW  
 0.35kg

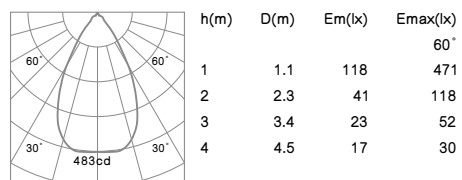
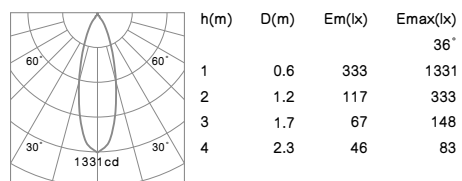
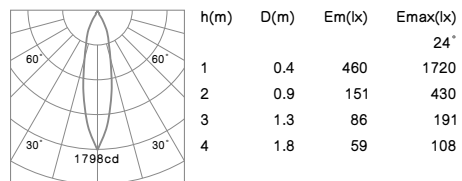

**R6153 10W 1200lm**  
 With LED Driver 36V-250mA  
 230V-50Hz

NW  
 0.35kg

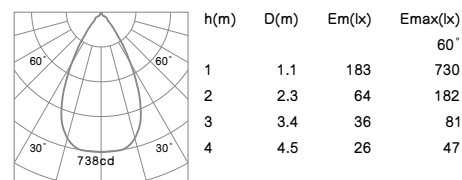
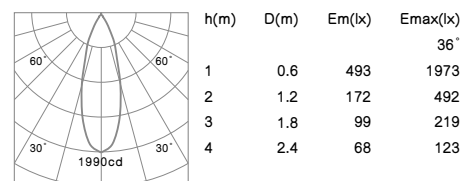
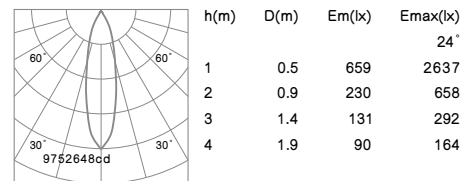

# AUDA



**COB LED CRI≥80 IP44 CE RoHS**

Mounting frame color: White Silver Black  
 Color temperature: 2700K 3000K 4000K  
 Beam angle: 24° 36° 60°

Driver gear for LED: Non-Dimmable  
 1-10V Dimmable  
 DALI Dimmable  
 Triac Dimmable

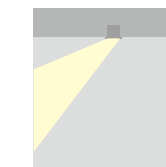

- Housing and Mounting ring: Cast aluminum.
- Light source: COB LED with a lens of optical.

•The down light tilts to a maximum of 0°-30° onto the vertical plane.

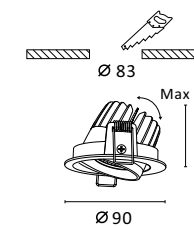

COB LED



**R6154 6W 700lm**  
 With LED Driver 36V-135mA  
 230V-50Hz

NW  
 0.37kg

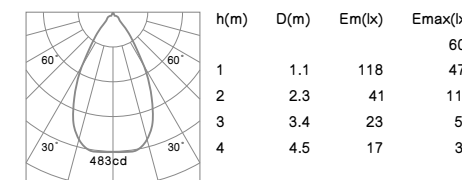
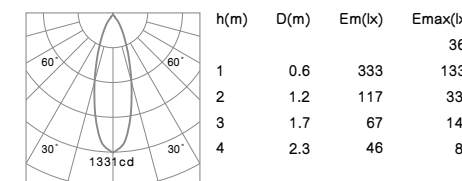
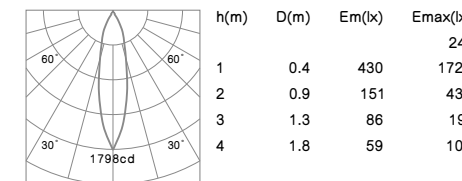

**R6154 10W 1200lm**  
 With LED Driver 36V-250mA  
 230V-50Hz

NW  
 0.37kg

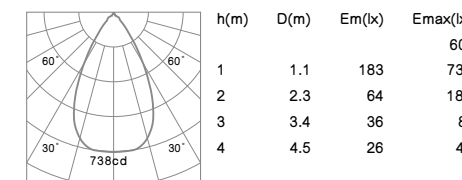
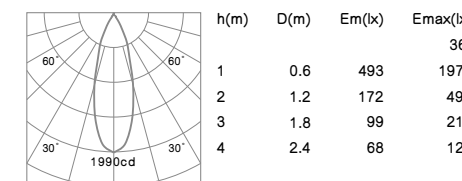
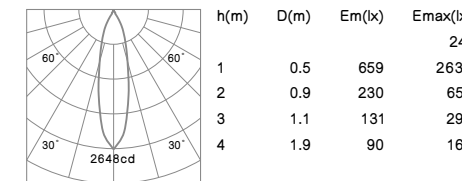

# AUDA



**COB LED CRI≥80 IP44 CE RoHS**

Mounting frame color: White Silver Black  
 Color temperature: 2700K 3000K 4000K  
 Beam angle: 24° 36°

Driver gear for LED: Non-Dimmable  
 1-10V Dimmable  
 DALI Dimmable  
 Triac Dimmable

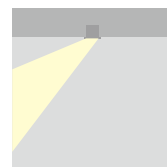

- Housing and Mounting ring: Cast aluminum.
- Light source: COB LED with a lens of optical.
- The down light tilts to a maximum of 0°-30° onto the vertical plane.

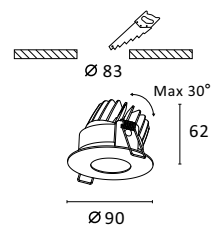

COB LED

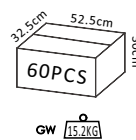

**R6255 6W 510lm**  
 With LED Driver 36V-135mA  
 230V-50Hz

NW  
 0.36kg

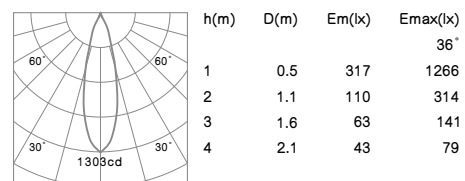
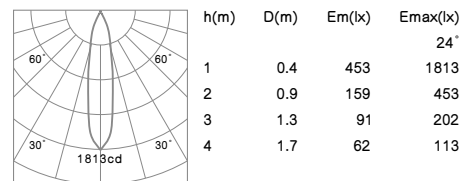

**R6255 10W 910lm**  
 With LED Driver 36V-250mA  
 230V-50Hz

NW  
 0.36kg

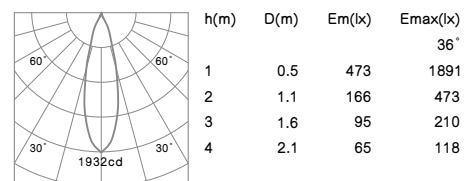
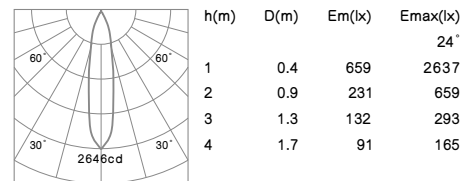

# AUDA



**COB LED CRI≥80 IP44 CE RoHS**

Mounting frame color: White Silver Black  
 Color temperature: 2700K 3000K 4000K  
 Beam angle: 24° 36°

Driver gear for LED: Non-Dimmable  
 1-10V Dimmable  
 DALI Dimmable  
 Triac Dimmable

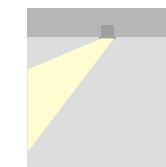

- Housing and Mounting ring: Cast aluminum.
- Light source: COB LED with a lens of optical.
- The down light tilts to a maximum of 0°-30° onto the vertical plane.

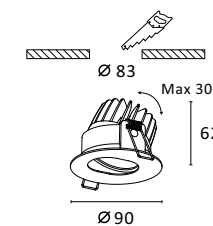

COB LED

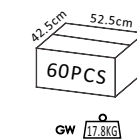

**R6254 6W 520lm**  
 With LED Driver 36V-135mA  
 230V-50Hz

NW  
 0.36kg

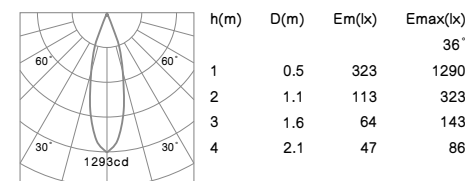
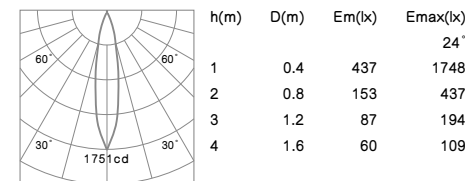

**R6254 10W 900lm**  
 With LED Driver 36V-250mA  
 230V-50Hz

NW  
 0.36kg

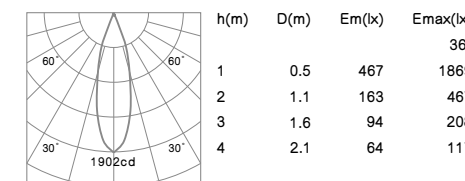
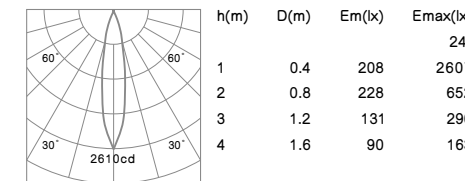



# AUDA



**COB LED CRI≥80 IP44 CE RoHS**  
 Mounting frame color: White Silver Black  
 Color temperature: 2700K 3000K 4000K  
 Beam angle: 24° 36° 60°

Driver gear for LED:  
 Non-Dimmable  
 1-10V Dimmable  
 DALI Dimmable  
 Triac Dimmable

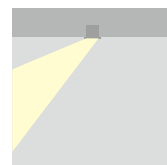

- Housing and Mounting ring: Cast aluminum.
- Light source: COB LED with a lens of optical.
- The down light tilts to a maximum of 0°-30° onto the vertical plane.

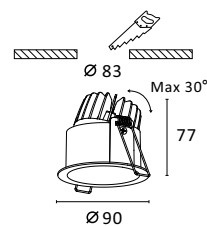

COB LED

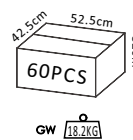

**R6020 6W 660lm**  
 With LED Driver 36V-135mA  
 230V-50Hz

NW  
 0.39kg

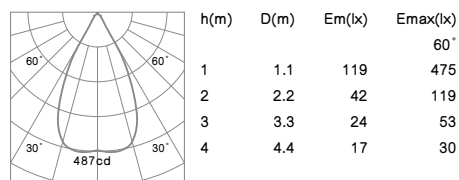
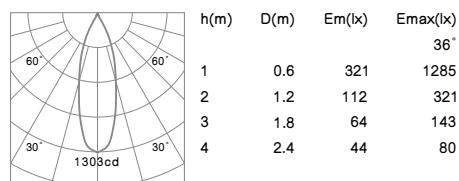
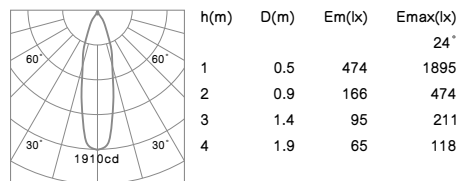

**R6020 10W 1100lm**  
 With LED Driver 36V-250mA  
 230V-50Hz

NW  
 0.39kg

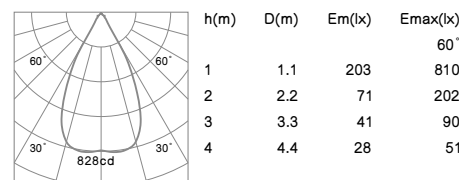
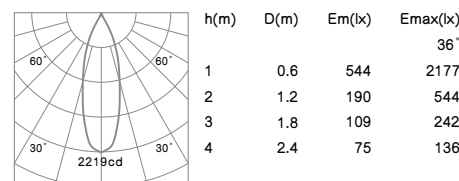
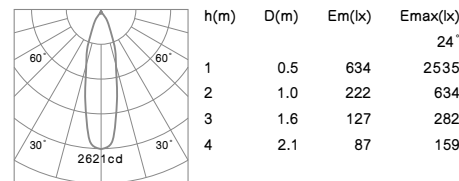

# AUDA



**COB LED CRI≥80 IP44 CE RoHS**  
 Mounting frame color: White Silver Black  
 Color temperature: 2700K 3000K 4000K  
 Beam angle: 24° 36° 60°

Driver gear for LED:  
 Non-Dimmable  
 1-10V Dimmable  
 DALI Dimmable  
 Triac Dimmable

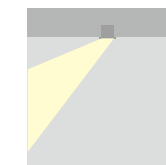

- Housing and Mounting ring: Cast aluminum.
- Light source: COB LED with a lens of optical.
- The down light tilts to a maximum of 0°-30° onto the vertical plane.

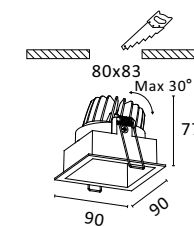

COB LED

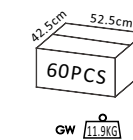

**R6215 6W 670lm**  
 With LED Driver 36V-135mA  
 230V-50Hz

NW  
 0.40kg

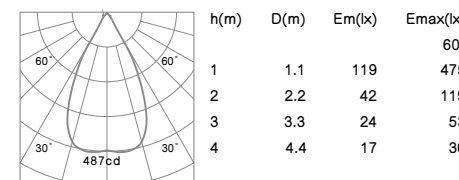
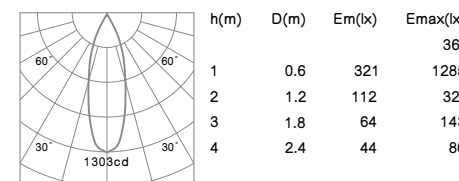
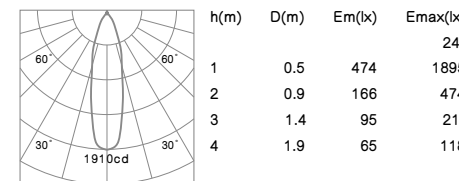

**R6215 10W 1130lm**  
 With LED Driver 36V-250mA  
 230V-50Hz

NW  
 0.40kg

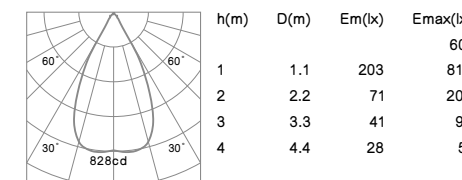
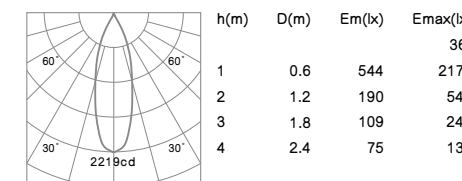
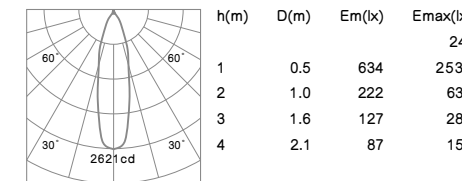

# AUDA



**COB LED CRI≥80 IP44 CE RoHS**  
 Mounting frame color: White Silver Black  
 Color temperature: 2700K 3000K 4000K  
 Beam angle: 24° 36° 60°

Driver gear for LED:  
 Non-Dimmable  
 1-10V Dimmable  
 DALI Dimmable  
 Triac Dimmable

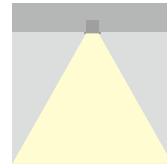

- Housing and Mounting ring: Cast aluminum.
- Light source: COB LED with a lens of optical.
- The light can be compatible with emergency battery.

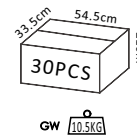
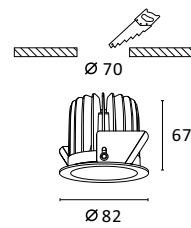

**R6104 15W 1540lm**  
 With LED Driver 36V-350mA  
 230V-50Hz

NW  
 0.42kg

h(m)	D(m)	Em(lx)	Emax(lx)
1	0.5	1019	4076
2	0.9	355	1015
3	1.4	203	451
4	1.8	140	254
5	2.3	105	162

h(m)	D(m)	Em(lx)	Emax(lx)
1	0.5	730	2920
2	1.1	256	730
3	1.6	146	324
4	2.1	101	183
5	2.7	76	117

h(m)	D(m)	Em(lx)	Emax(lx)
1	1.1	264	1056
2	2.3	92	264
3	3.4	53	117
4	4.5	36	66
5	5.6	27	42

# AUDA



**COB LED CRI≥80 IP44 CE RoHS**  
 Mounting frame color: White Silver Black  
 Color temperature: 2700K 3000K 4000K  
 Beam angle: 24° 36° 60°

Driver gear for LED:  
 Non-Dimmable  
 1-10V Dimmable  
 DALI Dimmable  
 Triac Dimmable

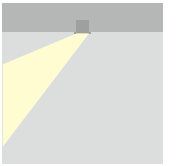

- Housing and Mounting ring: Cast aluminum.
- Light source: COB LED with a lens of optical.
- The down light tilts to a maximum of 0°-30° onto the vertical plane.

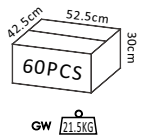
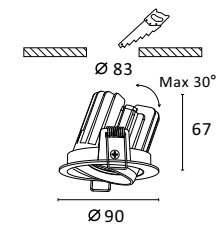

**R6108 15W 1550lm**  
 With LED Driver 36V-350mA  
 230V-50Hz

NW  
 0.44kg

h(m)	D(m)	Em(lx)	Emax(lx)
1	0.5	1019	4076
2	0.9	355	1015
3	1.3	203	451
4	1.8	140	254
5	2.3	105	162

h(m)	D(m)	Em(lx)	Emax(lx)
1	0.5	730	2920
2	1.1	256	730
3	1.6	146	324
4	2.1	101	183
5	2.7	76	117

h(m)	D(m)	Em(lx)	Emax(lx)
1	1.1	264	1056
2	2.3	92	264
3	3.4	53	117
4	4.5	36	66
5	5.6	27	42

# AUDA



**COB LED CRI≥80 IP44 CE RoHS**

Mounting frame color: White Silver Black  
 Color temperature: 2700K 3000K 4000K  
 Beam angle: 24° 36°

Driver gear for LED: Non-Dimmable  
 1-10V Dimmable  
 DALI Dimmable  
 Triac Dimmable

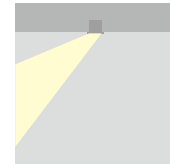

- Housing and Mounting ring: Cast aluminum.
- Light source: COB LED with a lens of optical.
- The down light tilts to a maximum of 0°-30° onto the vertical plane.

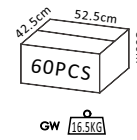
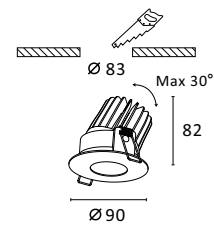

**R6171 15W 1170lm**  
 With LED Driver 36V-350mA  
 230V-50Hz

NW  
 0.43kg

h(m)	D(m)	Em(lx)	E <sub>max</sub> (lx)
1	0.5	958	3832
2	0.9	335	958
3	1.4	192	426
4	1.8	132	240
5	2.3	99	153

h(m)	D(m)	Em(lx)	E <sub>max</sub> (lx)
1	0.6	700	2798
2	1.1	245	700
3	1.7	140	311
4	2.3	96	175
5	2.8	73	112

# AUDA



**COB LED CRI≥80 IP44 CE RoHS**

Mounting frame color: White Silver Black  
 Color temperature: 2700K 3000K 4000K  
 Beam angle: 24° 36°

Driver gear for LED: Non-Dimmable  
 1-10V Dimmable  
 DALI Dimmable  
 Triac Dimmable

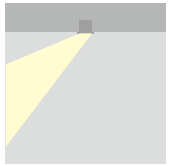

- Housing and Mounting ring: Cast aluminum.
- Light source: COB LED with a lens of optical.
- The down light tilts to a maximum of 0°-30° onto the vertical plane.

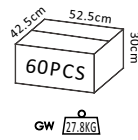
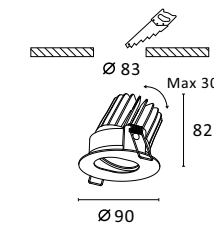

**R6198 15W 1150lm**  
 With LED Driver 36V-350mA  
 230V-50Hz

NW  
 0.43kg

h(m)	D(m)	Em(lx)	E <sub>max</sub> (lx)
1	0.5	928	3710
2	1.1	324	927
3	1.6	185	412
4	2.2	128	232
4	2.7	96	148

h(m)	D(m)	Em(lx)	E <sub>max</sub> (lx)
1	0.5	691	2762
2	1.1	242	691
3	1.6	138	307
4	2.1	95	173
4	2.7	72	111



# AUDA

**COB LED CRI≥80 IP44 CE RoHS**  
 Mounting frame color: White Silver Black  
 Color temperature: 2700K 3000K 4000K  
 Beam angle: 24° 36° 60°

Driver gear for LED:  
 Non-Dimmable  
 1-10V Dimmable  
 DALI Dimmable  
 Triac Dimmable

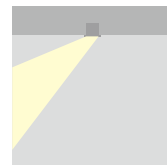

- Housing and Mounting ring: Cast aluminum.
- Light source: COB LED with a lens of optical.
- The down light tilts to a maximum of 0°-30° onto the vertical plane.

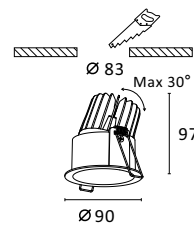

COB LED

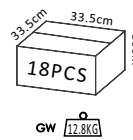

**R6199 15W 1440lm**  
 With LED Driver 36V-350mA  
 230V-50Hz

NW  
 0.46kg

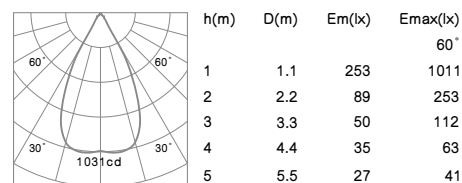
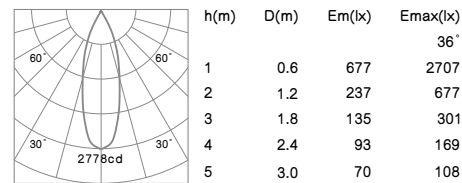
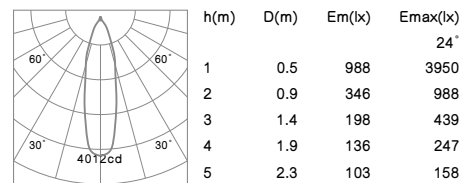

# AUDA

**COB LED CRI≥80 IP44 CE RoHS**  
 Mounting frame color: White Silver Black  
 Color temperature: 2700K 3000K 4000K  
 Beam angle: 24° 36° 60°

Driver gear for LED:  
 Non-Dimmable  
 1-10V Dimmable  
 DALI Dimmable  
 Triac Dimmable

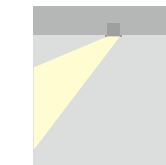

- Housing and Mounting ring: Cast aluminum.
- Light source: COB LED with a lens of optical.
- The down light tilts to a maximum of 0°-30° onto the vertical plane.

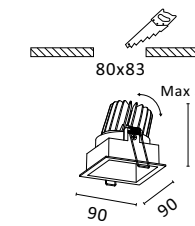

COB LED

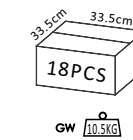

**R6248 15W 1450lm**  
 With LED Driver 36V-350mA  
 230V-50Hz

NW  
 0.47kg

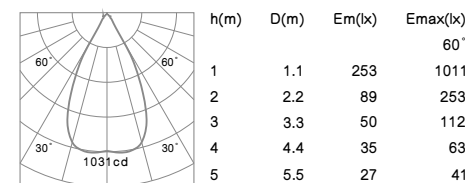
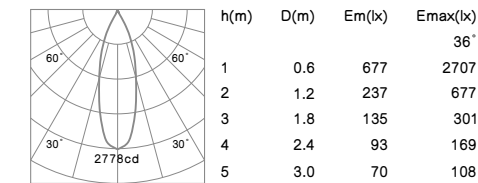
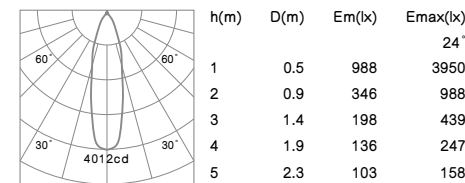



SIMPA



117

SIMPA

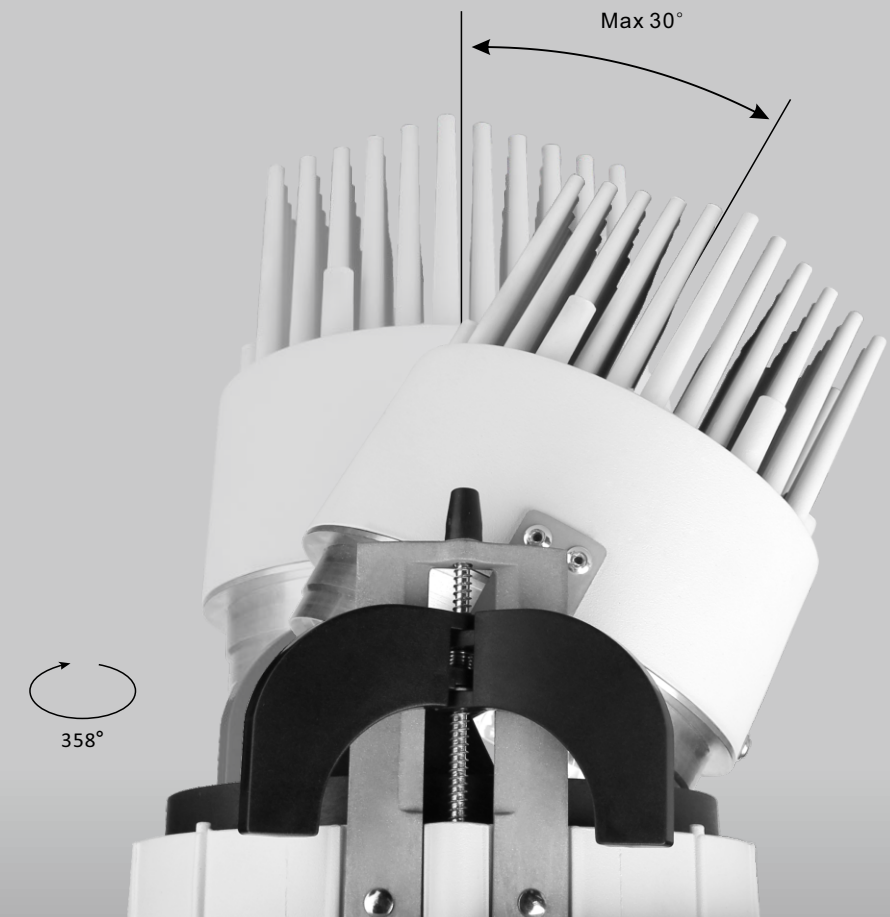

### Adjustable Direction Design

The spot light tilts to a maximum of  $0^{\circ}$  -  $30^{\circ}$  onto the vertical plane and rotates by  $358^{\circ}$  onto the horizontal plane.  
The lighting angle and direction can be adjusted according to the scene used.

(R6316)

118



Isoline Of Wall Washer

The Effect Of Wall Washer

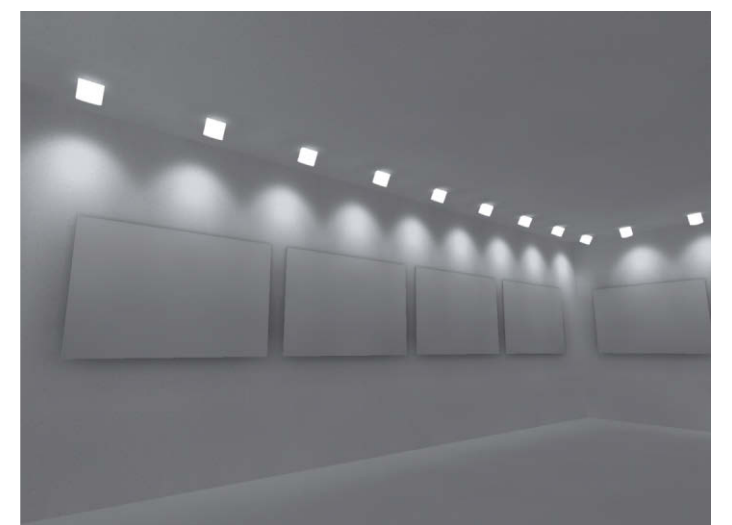



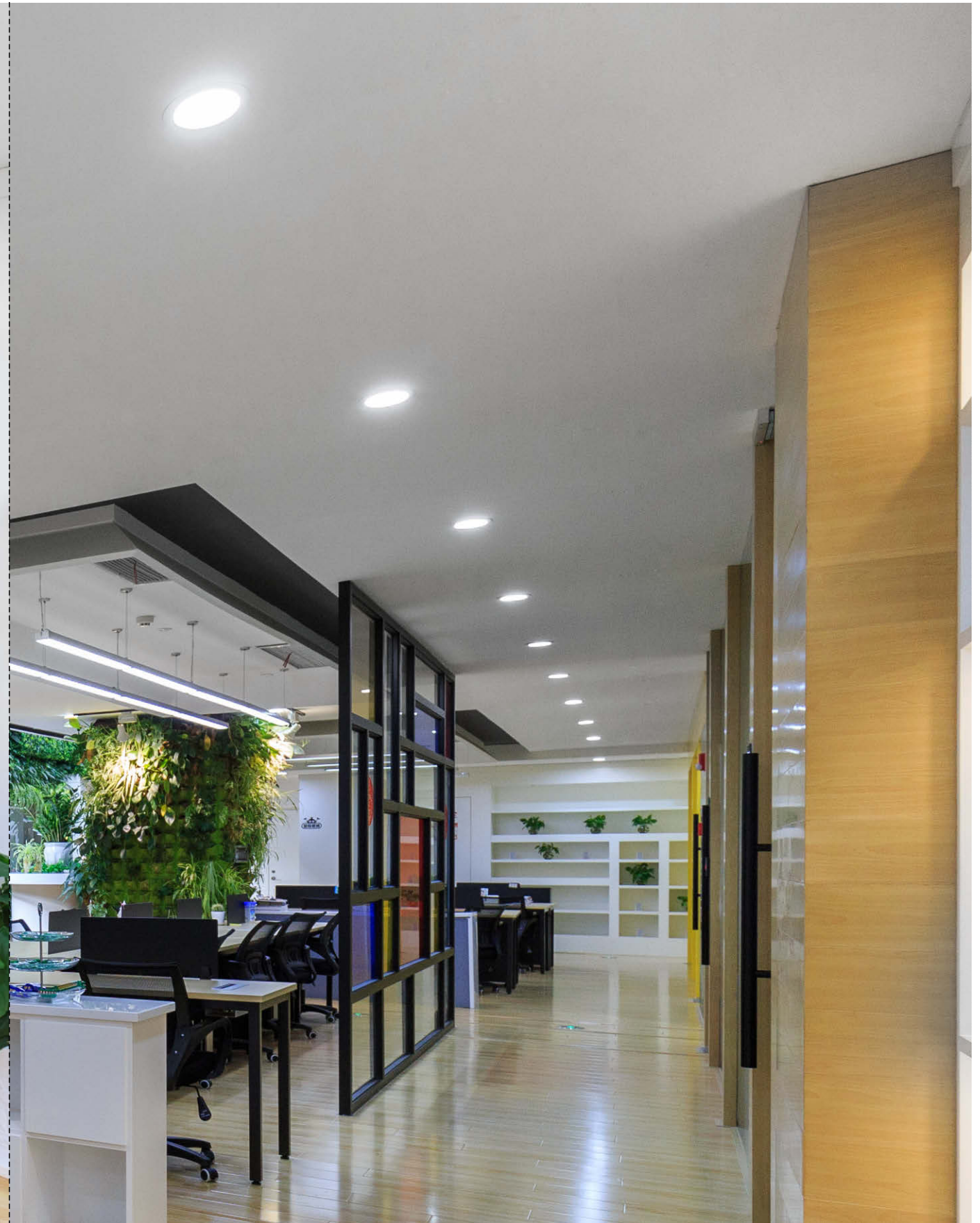





M Ø 150mm 15W 20W 25W

P126



L Ø 180mm 20W 25W 30W 40W

P128

Wall Wash Light



M Ø 150mm 15W 20W 25W

P131



L Ø 180mm 20W 25W 30W 40W

P132



# SIMPA

# SIMPA M



S    Ø 115mm    10W 15W 20W 25W

P133

P134



M    Ø 150mm    15W 20W 25W

P135

P136



L    Ø 180mm    30W 40W

P137

P138



**COB LED**    **CRI≥80**    **IP20**    **CE**    **RoHS**  
 Mounting frame color:    White    Silver    Black  
 Color temperature:    2700K    3000K    4000K  
 Beam angle:    15°    24°    36°    60°

Driver gear for LED:    Non-Dimmable  
    1-10V Dimmable  
    DALI Dimmable  
    Triac Dimmable

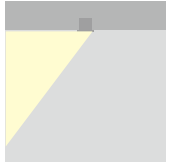

- Housing and Mounting ring: Cast aluminum.
- The spot light tilts to a maximum of 0°-30° onto the vertical plane and rotates by 358° onto the horizontal plane.
- Light source: COB LED with a high efficiency reflector of optical.
- Reflector: Aluminum satin-matt anodised.
- The light can be compatible with emergency battery.

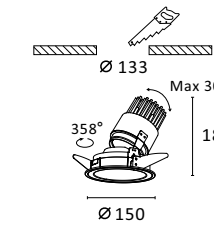

COB LED

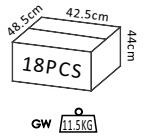

**R6093 15W 1390lm**  
 With LED Driver 36V-350mA  
 230V-50Hz

NW  
 1.14kg

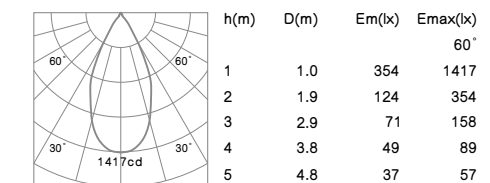
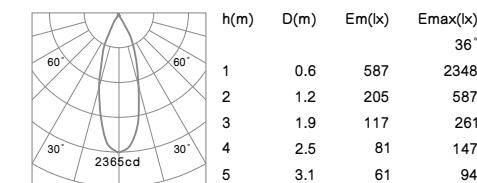
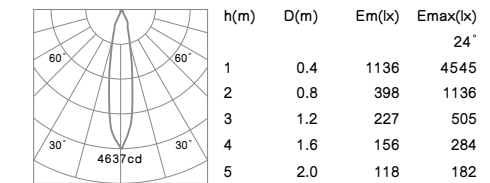
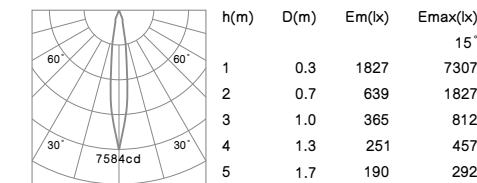



R6316 25W 2190lm  
With LED Driver 36V-600mA  
230V-50Hz

NW  
1.55kg

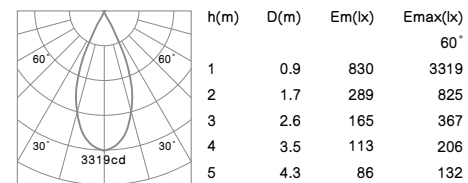
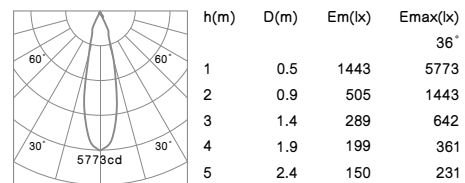
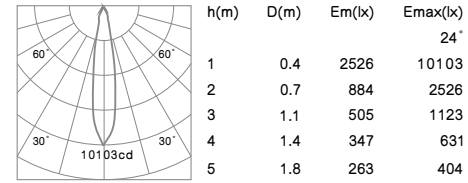
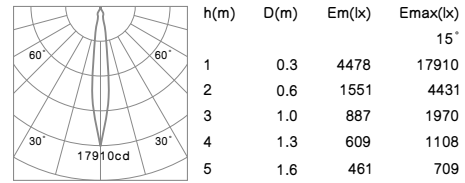

R6316 30W 2910lm  
With LED Driver 36V-800mA  
230V-50Hz

NW  
1.55kg

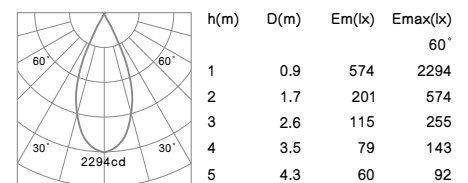
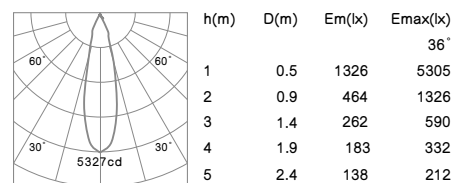
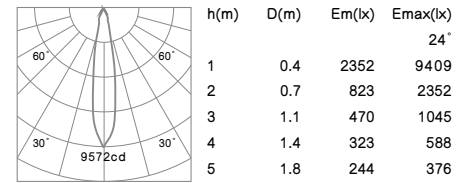
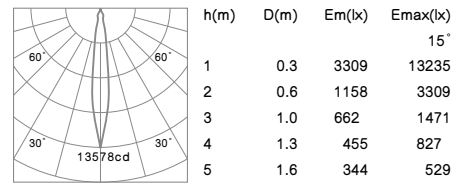

R6316 40W 3540lm  
With LED Driver 36V-1050mA  
230V-50Hz

NW  
1.55kg

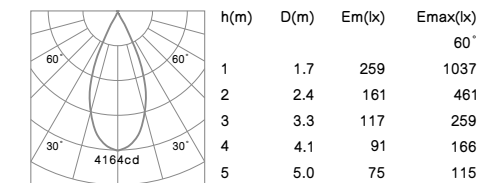
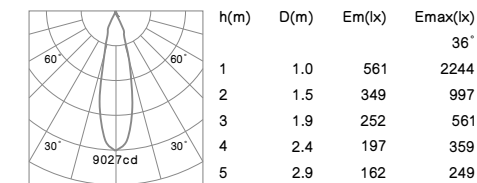
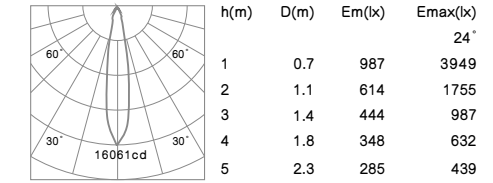
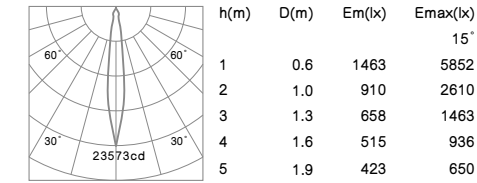



# SIMPA Wall Wash Light M



COB LED	CRI≥80	IP20	CE	RoHS
Mounting frame color:	White	Silver	Black	
Color temperature:	2700K	3000K	4000K	

Driver gear for LED:

- Non-Dimmable
- 1-10V Dimmable
- DALI Dimmable
- Triac Dimmable

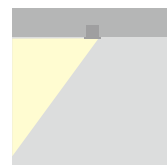

- Housing and Mounting ring: Cast aluminum.
- Light source: COB LED with a high efficiency optical reflector and acrylic diffuser.
- Reflector: Aluminum bright anodised.

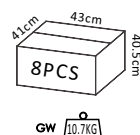
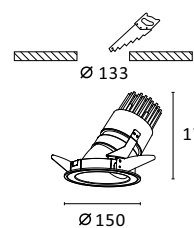

**R6094 15W 1160lm**  
With LED Driver 36V-350mA  
230V-50Hz

NW  
1.08kg

Mean illuminance E <sub>v</sub> (lx)	
Wall height(m)	4.0
Offset from wall(m)	0.9 0.9 1.2 1.2
Luminaire spacing(m)	0.9 1.2 1.2 1.5
Illuminance E <sub>v</sub> (lx)	265 233 175 157

**R6094 20W 1580lm**  
With LED Driver 36V-500mA  
230V-50Hz

NW  
1.08kg

Mean illuminance E <sub>v</sub> (lx)	
Wall height(m)	4.0
Offset from wall(m)	0.9 0.9 1.2 1.2
Luminaire spacing(m)	0.9 1.2 1.2 1.5
Illuminance E <sub>v</sub> (lx)	367 316 236 217

**R6094 25W 1780lm**  
With LED Driver 36V-600mA  
230V-50Hz

NW  
1.08kg

Mean illuminance E <sub>v</sub> (lx)	
Wall height(m)	4.0
Offset from wall(m)	0.9 0.9 1.2 1.2
Luminaire spacing(m)	0.9 1.2 1.2 1.5
Illuminance E <sub>v</sub> (lx)	411 354 264 242

# SIMPA Wall Wash Light L



COB LED	CRI≥80	IP20	CE	RoHS
Mounting frame color:	White	Silver	Black	
Color temperature:	2700K	3000K	4000K	

Driver gear for LED:

- Non-Dimmable
- 1-10V Dimmable
- DALI Dimmable
- Triac Dimmable

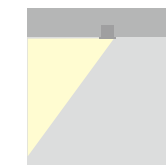

- Housing and Mounting ring: Cast aluminum.
- Light source: COB LED with a high efficiency optical reflector and acrylic diffuser.
- Reflector: Aluminum bright anodised.

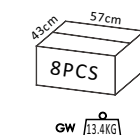
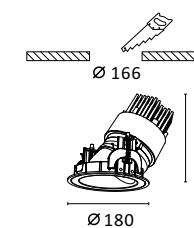

**R6321 20W 1430lm**  
With LED Driver 36V-500mA  
230V-50Hz

NW  
1.55kg

Mean illuminance E <sub>v</sub> (lx)	
Wall height(m)	4.0
Offset from wall(m)	0.9 0.9 1.2 1.2
Luminaire spacing(m)	0.9 1.2 1.2 1.5
Illuminance E <sub>v</sub> (lx)	317 272 203 186

**R6321 25W 1690lm**  
With LED Driver 36V-600mA  
230V-50Hz

NW  
1.55kg

Mean illuminance E <sub>v</sub> (lx)	
Wall height(m)	4.0
Offset from wall(m)	0.9 0.9 1.2 1.2
Luminaire spacing(m)	0.9 1.2 1.2 1.5
Illuminance E <sub>v</sub> (lx)	356 305 228 208

**R6321 30W 2260lm**  
With LED Driver 36V-800mA  
230V-50Hz

NW  
1.55kg

Mean illuminance E <sub>v</sub> (lx)	
Wall height(m)	4.0
Offset from wall(m)	0.9 0.9 1.2 1.2
Luminaire spacing(m)	0.9 1.2 1.2 1.5
Illuminance E <sub>v</sub> (lx)	503 432 322 295

**R6321 40W 2820lm**  
With LED Driver 36V-1050mA  
230V-50Hz

NW  
1.55kg

Mean illuminance E <sub>v</sub> (lx)	
Wall height(m)	4.0
Offset from wall(m)	0.9 0.9 1.2 1.2
Luminaire spacing(m)	0.9 1.2 1.2 1.5
Illuminance E <sub>v</sub> (lx)	638 547 409 374

# SIMPA s



**COB LED CRI≥80 IP44 CE RoHS**  
 Mounting frame color: White Silver Black  
 Color temperature: 2700K 3000K 4000K  
 Beam angle: 50°

Driver gear for LED:  
 Non-Dimmable  
 1-10V Dimmable  
 DALI Dimmable  
 Triac Dimmable

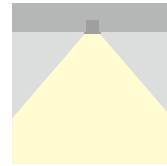

- Housing and Mounting ring: Cast aluminum.
- Light source: COB LED with a high efficiency reflector of optical and clear glass.
- The light can be compatible with emergency battery.

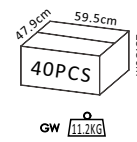
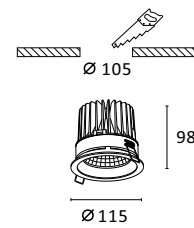

**R6196 10W 1070lm**  
 With LED Driver 36V-250mA  
 230V-50Hz

NW  
 0.72kg

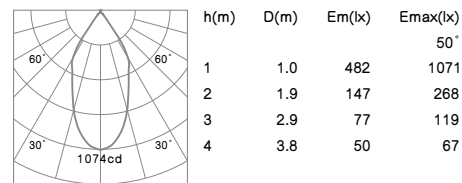

**R6196 15W 1390lm**  
 With LED Driver 36V-350mA  
 230V-50Hz

NW  
 0.72kg

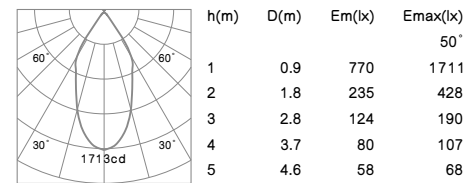

**R6196 20W 1970lm**  
 With LED Driver 36V-500mA  
 230V-50Hz

NW  
 0.72kg

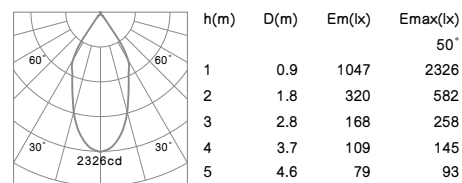

**R6196 25W 2100lm**  
 With LED Driver 36V-600mA  
 230V-50Hz

NW  
 0.72kg

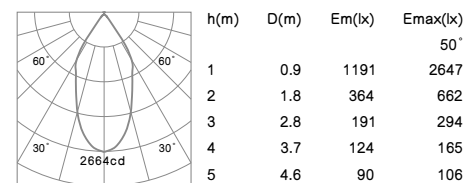

# SIMPA s



**COB LED CRI≥80 IP44 CE RoHS**  
 Mounting frame color: White Silver Black  
 Color temperature: 2700K 3000K 4000K  
 Beam angle: 75°

Driver gear for LED:  
 Non-Dimmable  
 1-10V Dimmable  
 DALI Dimmable  
 Triac Dimmable

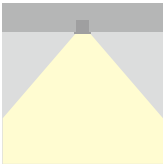

- Housing and Mounting ring: Cast aluminum.
- Light source: COB LED with a high efficiency reflector of optical and acrylic diffuser.
- The light can be compatible with emergency battery.

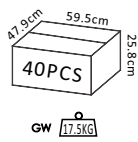
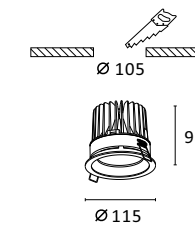

**R6195 10W 770lm**  
 With LED Driver 36V-250mA  
 230V-50Hz

NW  
 0.72kg

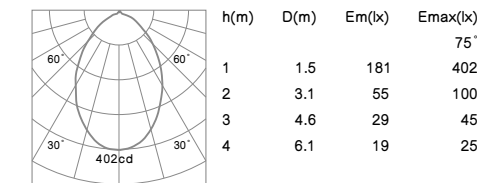

**R6195 15W 1010lm**  
 With LED Driver 36V-350mA  
 230V-50Hz

NW  
 0.72kg

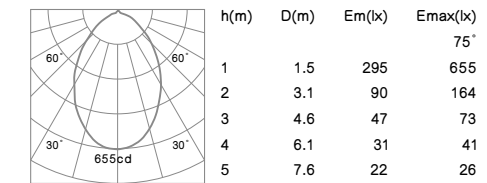

**R6195 20W 1420lm**  
 With LED Driver 36V-500mA  
 230V-50Hz

NW  
 0.72kg

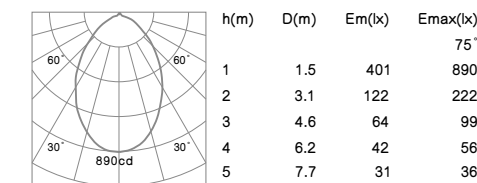

**R6195 25W 1600lm**  
 With LED Driver 36V-600mA  
 230V-50Hz

NW  
 0.72kg

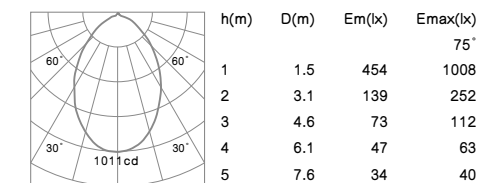

# SIMPA M



**COB LED CRI≥80 IP44 CE RoHS**  
 Mounting frame color: White Silver Black  
 Color temperature: 2700K 3000K 4000K  
 Beam angle: 60°

Driver gear for LED:  
 Non-Dimmable  
 1-10V Dimmable  
 DALI Dimmable  
 Triac Dimmable

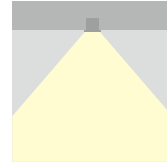

- Housing and Mounting ring: Cast aluminum.
- Light source: COB LED with a high efficiency reflector of optical and clear glass.
- The light can be compatible with emergency battery.

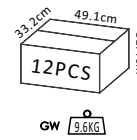
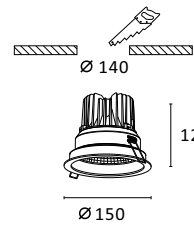

**R6202 15W 1420lm**  
 With LED Driver 36V-350mA  
 230V-50Hz

NW  
 1.24kg

h(m)	D(m)	Em(lx)	E <sub>max</sub> (lx)
1	1.1	681	1514
2	2.2	208	379
3	3.3	109	168
4	4.4	71	95
5	5.5	52	61

**R6202 20W 2010lm**  
 With LED Driver 36V-500mA  
 230V-50Hz

NW  
 1.24kg

h(m)	D(m)	Em(lx)	E <sub>max</sub> (lx)
1	1.1	932	2070
2	2.2	285	518
3	3.3	150	230
4	4.4	97	129
5	5.5	71	83

**R6202 25W 2320lm**  
 With LED Driver 36V-600mA  
 230V-50Hz

NW  
 1.24kg

h(m)	D(m)	Em(lx)	E <sub>max</sub> (lx)
1	1.1	1054	2343
2	2.2	322	586
3	3.2	169	260
4	4.3	110	146
5	5.4	80	94

# SIMPA M



**COB LED CRI≥80 IP44 CE RoHS**  
 Mounting frame color: White Silver Black  
 Color temperature: 2700K 3000K 4000K  
 Beam angle: 75°

Driver gear for LED:  
 Non-Dimmable  
 1-10V Dimmable  
 DALI Dimmable  
 Triac Dimmable

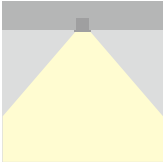

- Housing and Mounting ring: Cast aluminum.
- Light source: COB LED with a high efficiency reflector of optical and acrylic diffuser.
- The light can be compatible with emergency battery.

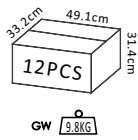
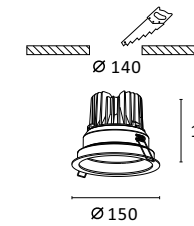

**R6201 15W 1200lm**  
 With LED Driver 36V-350mA  
 230V-50Hz

NW  
 1.24kg

h(m)	D(m)	Em(lx)	E <sub>max</sub> (lx)
1	1.6	273	606
2	3.1	84	152
3	4.7	44	67
4	6.2	29	38
5	7.8	20	24

**R6201 20W 1690lm**  
 With LED Driver 36V-500mA  
 230V-50Hz

NW  
 1.24kg

h(m)	D(m)	Em(lx)	E <sub>max</sub> (lx)
1	1.5	370	822
2	3.1	113	206
3	4.6	59	91
4	6.2	38	51
5	7.7	28	33

**R6201 25W 1950lm**  
 With LED Driver 36V-600mA  
 230V-50Hz

NW  
 1.24kg

h(m)	D(m)	Em(lx)	E <sub>max</sub> (lx)
1	1.5	419	931
2	3.1	128	233
3	4.6	68	104
4	6.1	44	58
5	7.6	31	37

# SIMPA L



**COB LED CRI≥80 IP44 CE RoHS**  
 Mounting frame color: White Silver Black  
 Color temperature: 2700K 3000K 4000K  
 Beam angle: 50°

Driver gear for LED:  
 Non-Dimmable  
 1-10V Dimmable  
 DALI Dimmable  
 Triac Dimmable

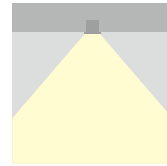

- Housing and Mounting ring: Cast aluminum.
- Light source: COB LED with a high efficiency reflector of optical and clear glass.
- The light can be compatible with emergency battery.

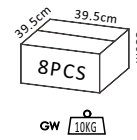
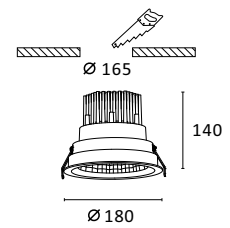

**R6326 30W 2900lm**  
 With LED Driver 36V-800mA  
 230V-50Hz

NW  
 1.10kg

	h(m)	D(m)	Em(lx)	E <sub>max</sub> (lx)
				50°
	1	0.9	1467	3259
	2	1.8	448	815
	3	2.7	235	362
	4	3.6	153	204
	5	4.5	111	130

**R6326 40W 3800lm**  
 With LED Driver 36V-1050mA  
 230V-50Hz

NW  
 1.10kg

	h(m)	D(m)	Em(lx)	E <sub>max</sub> (lx)
				50°
	1	0.9	1839	4087
	2	1.8	562	1022
	3	2.7	295	454
	4	3.6	191	255
	5	4.4	139	163

# SIMPA L



**COB LED CRI≥80 IP44 CE RoHS**  
 Mounting frame color: White Silver Black  
 Color temperature: 2700K 3000K 4000K  
 Beam angle: 85°

Driver gear for LED:  
 Non-Dimmable  
 1-10V Dimmable  
 DALI Dimmable  
 Triac Dimmable

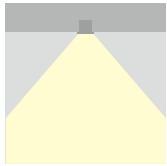

- Housing and Mounting ring: Cast aluminum.
- Light source: COB LED with a high efficiency reflector of optical and acrylic diffuser.
- The light can be compatible with emergency battery.

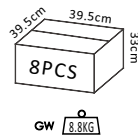
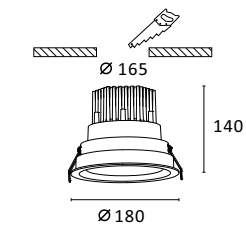

**R6327 30W 2800lm**  
 With LED Driver 36V-800mA  
 230V-50Hz

NW  
 0.93kg

	h(m)	D(m)	Em(lx)	E <sub>max</sub> (lx)
				85°
	1	1.8	683	1517
	2	3.5	208	379
	3	5.3	110	169
	4	7.1	71	95
	5	8.9	52	61

**R6327 40W 3730lm**  
 With LED Driver 36V-1050mA  
 230V-50Hz

NW  
 0.93kg

	h(m)	D(m)	Em(lx)	E <sub>max</sub> (lx)
				85°
	1	1.8	804	1786
	2	3.5	246	447
	3	5.3	129	199
	4	7.1	84	112
	5	8.9	60	71



SIMP B

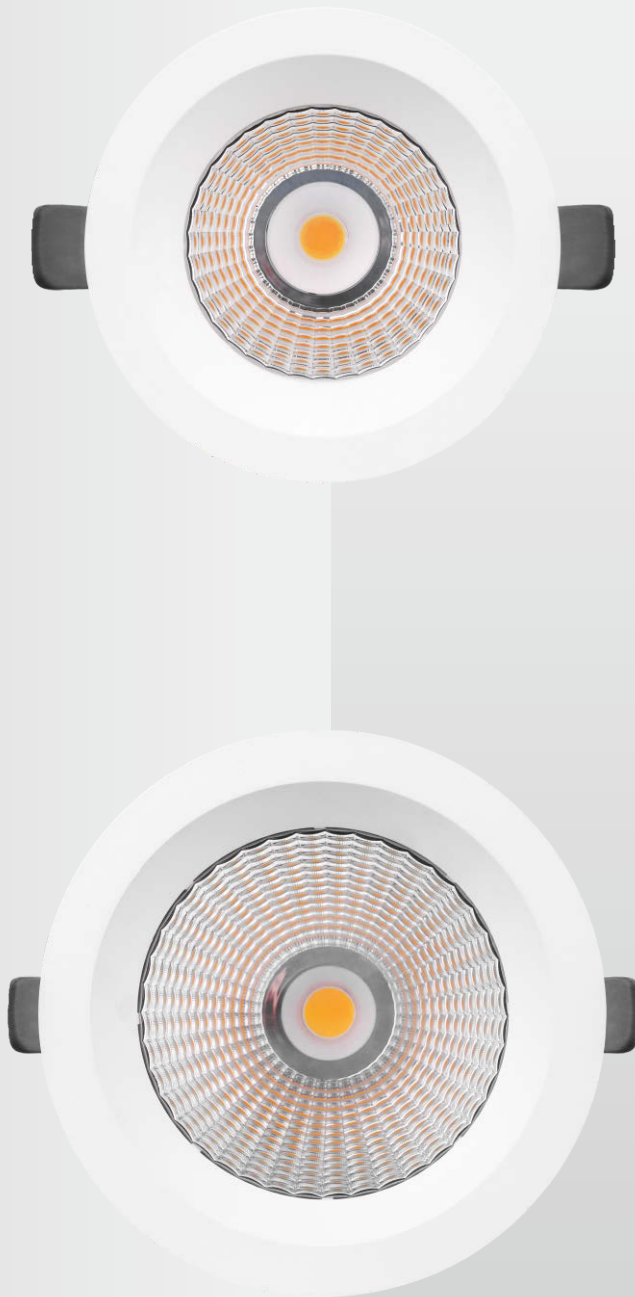

139

SIMP B



140



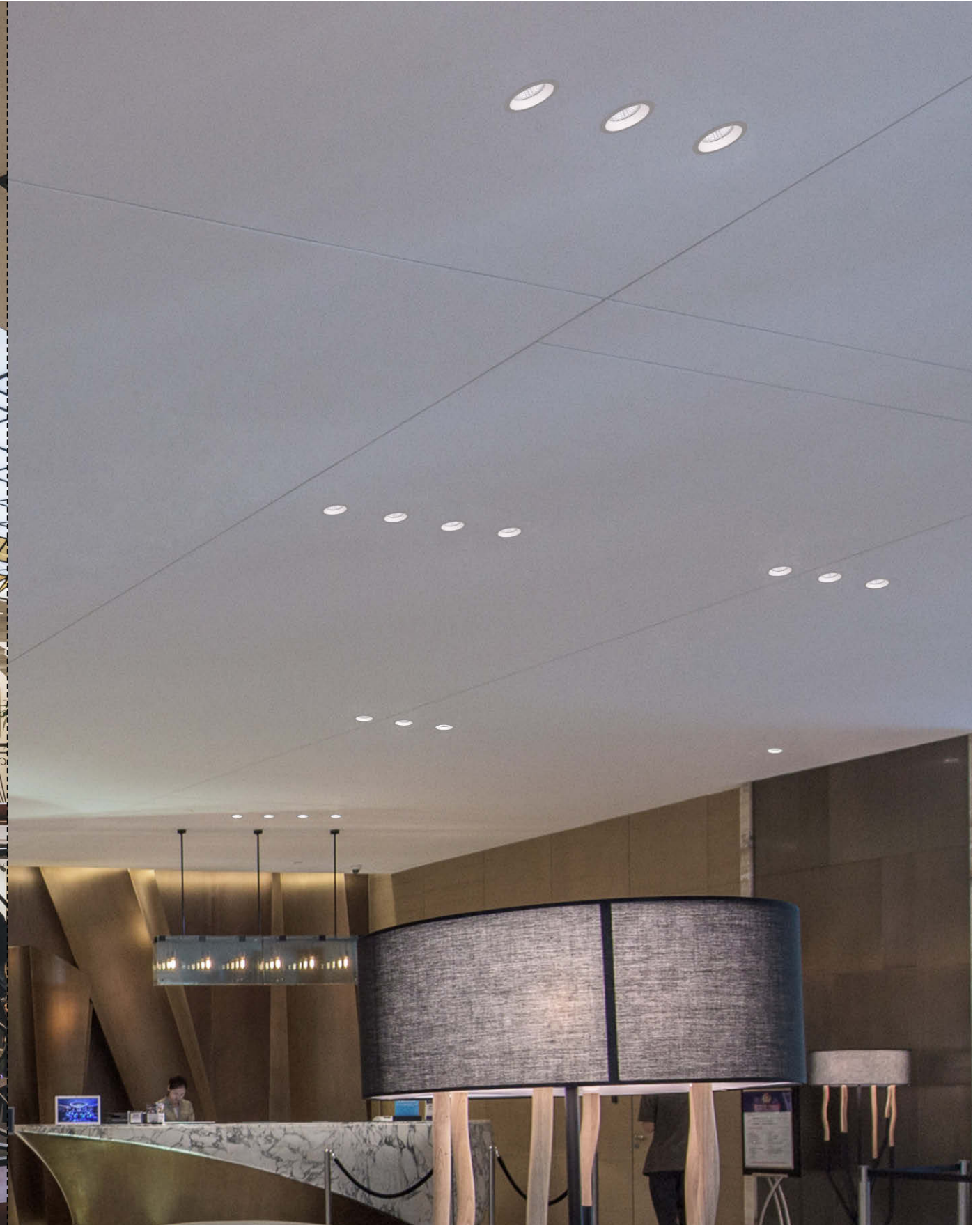



# SIMP B



M Ø 110mm 15W 20W 25W P144



L Ø 150mm 20W 25W 30W 40W P146

# SIMP B M



**COB LED CRI≥80 IP44 CE RoHS**  
 Mounting frame color: White Silver Black  
 Color temperature: 2700K 3000K 4000K  
 Beam angle: 24° 36° 60°

Driver gear for LED:  
 Non-Dimmable  
 1-10V Dimmable  
 DALI Dimmable  
 Triac Dimmable

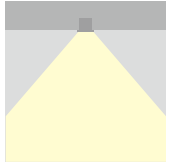

- Housing and Mounting ring: Cast aluminum.
- Light source: COB LED with a high efficiency reflector of optical and clear glass.
- The light can be compatible with emergency battery.

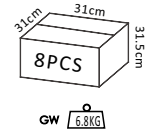
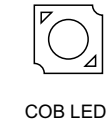
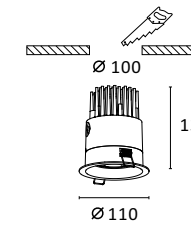

R6285 15W 1500lm  
 With LED Driver 36V-350mA  
 230V-50Hz

NW  
 0.87kg

h(m)	D(m)	Em(lx)	E <sub>max</sub> (lx)
			24°
1	0.4	1299	5195
2	0.7	455	1299
3	1.1	260	577
4	1.5	179	325
5	1.9	135	208

h(m)	D(m)	Em(lx)	E <sub>max</sub> (lx)
			36°
1	0.6	603	2413
2	1.2	211	603
3	1.9	121	268
4	2.5	83	151
5	3.1	63	97

h(m)	D(m)	Em(lx)	E <sub>max</sub> (lx)
			60°
1	1.1	322	1286
2	2.3	112	321
3	3.4	64	143
4	4.5	44	80
5	5.6	33	51

# SIMP B M

R6285 20W 2000lm  
With LED Driver 36V-500mA  
230V-50Hz

NW  
0.87kg

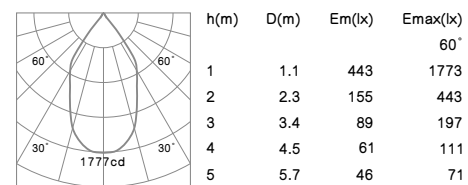
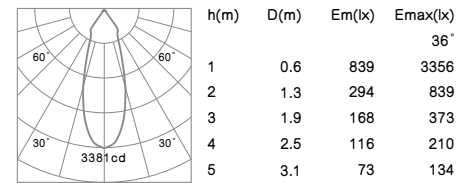
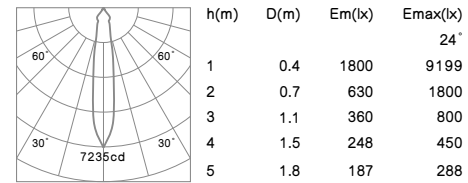

R6285 25W 2400lm  
With LED Driver 36V-600mA  
230V-50Hz

NW  
0.87kg

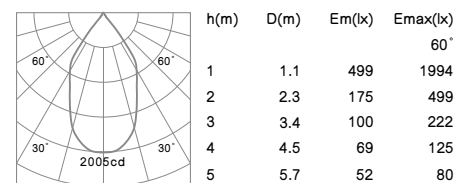
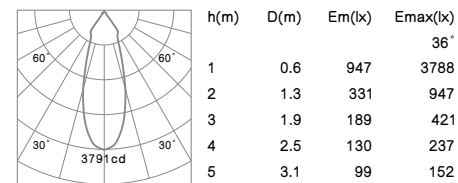
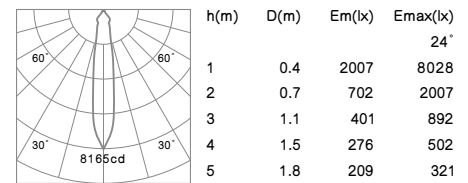

# SIMP B L



COB LED CRI≥80 IP44 CE RoHS

Mounting frame color: White Silver Black  
Color temperature: 2700K 3000K 4000K  
Beam angle: 24° 36° 60°

Driver gear for LED: Non-Dimmable  
1-10V Dimmable  
DALI Dimmable  
Triac Dimmable

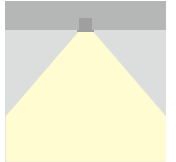

- Housing and Mounting ring: Cast aluminum.
- Light source: COB LED with a high efficiency reflector of optical and clear glass.
- The light can be compatible with emergency battery.

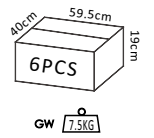
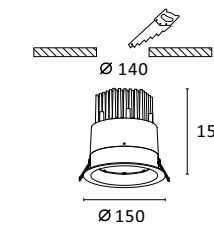

R6270 20W 2000lm  
With LED Driver 36V-500mA  
230V-50Hz

NW  
1.26kg

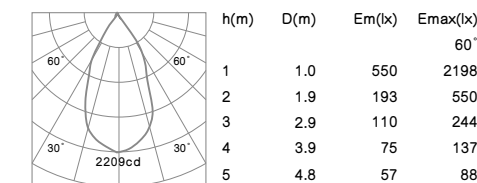
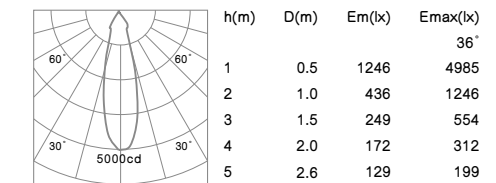
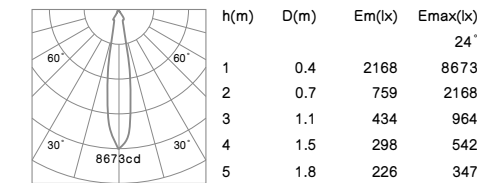



# SIMP B L

R6270 25W 2300lm  
With LED Driver 36V-600mA  
230V-50Hz

NW  
1.26kg

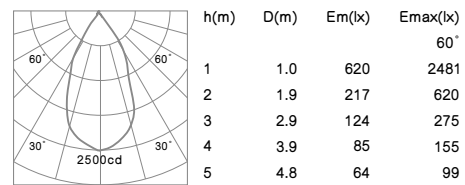
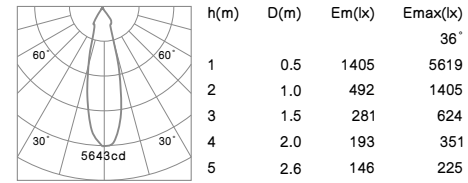
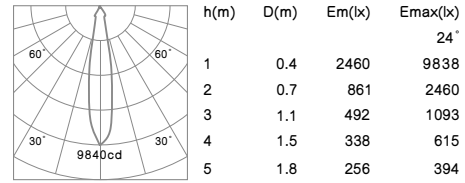

R6270 30W 3000lm  
With LED Driver 36V-800mA  
230V-50Hz

NW  
1.26kg

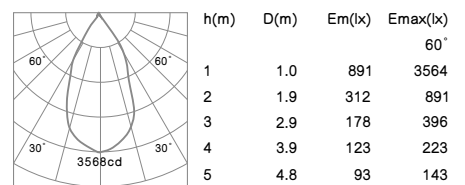
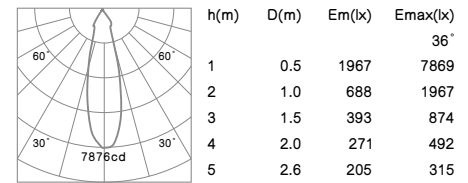
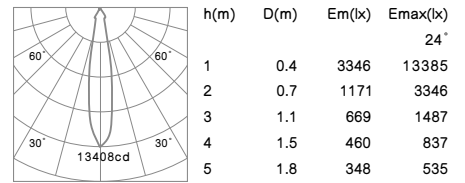

# SIMP B L

R6270 40W 3800lm  
With LED Driver 36V-1050mA  
230V-50Hz

NW  
1.26kg

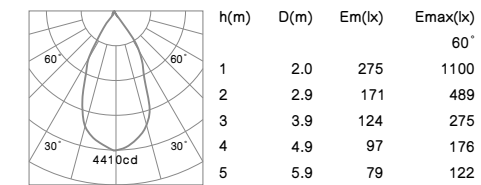
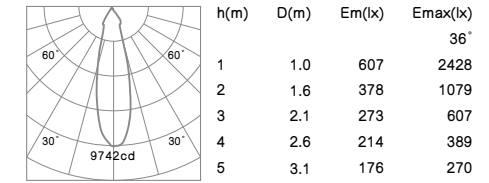
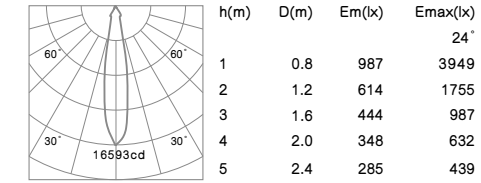

TINA

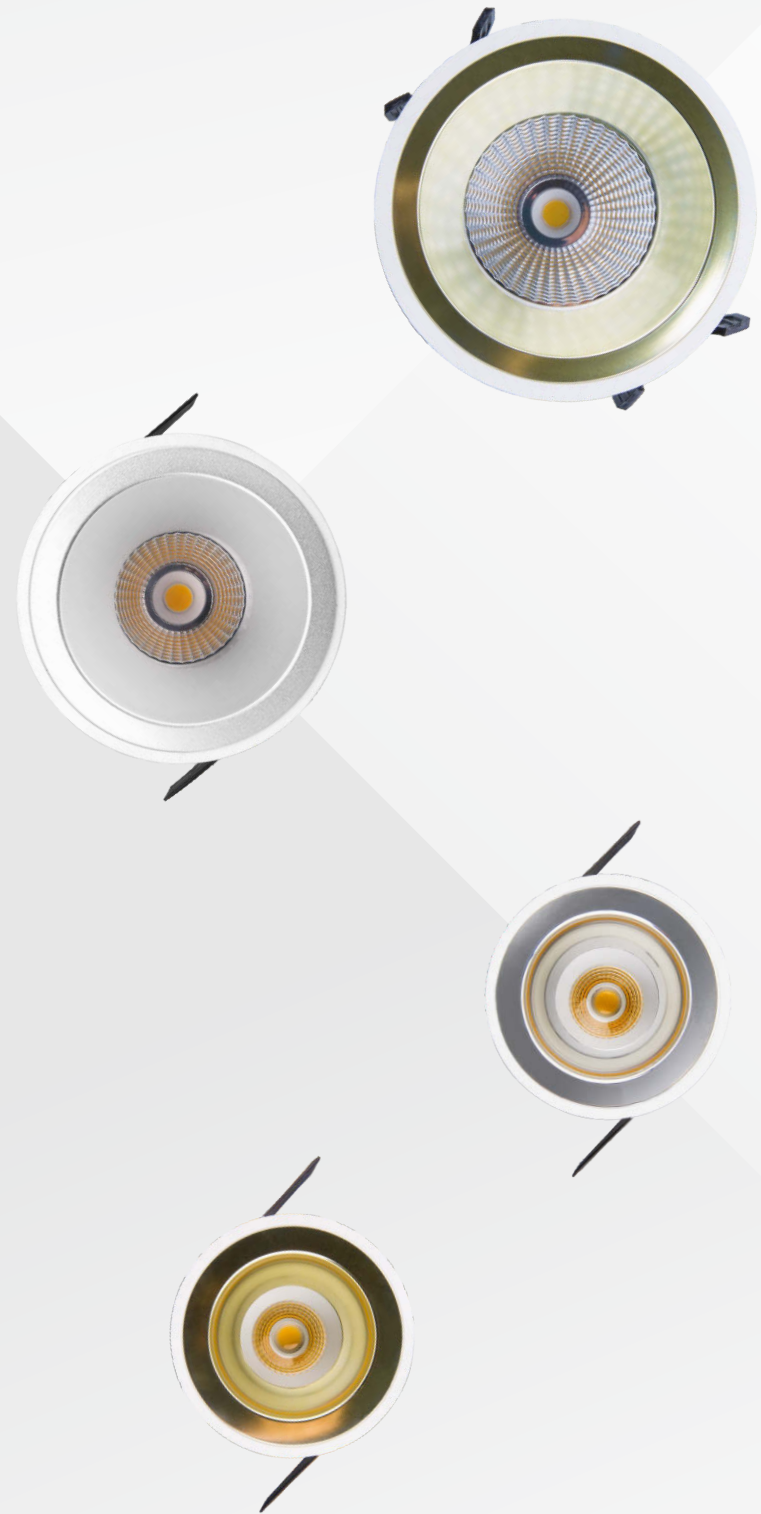

TINA







# TINA



RM (mirror)



RS (satin silver)



RG (champagne gold)



S Ø 115mm 6W 10W

P154



S Ø 115mm 6W 10W

P155



S Ø 115mm 15W

P156



S Ø 115mm 15W

P157



M Ø 150mm 15W 20W 25W

P158



L Ø 180mm 20W 25W 30W 40W

P160

# TINA s



COB LED CRI≥80 IP44 CE RoHS

Reflector Color: RM RG

Mounting frame color: White Silver Black  
Color temperature: 2700K 3000K 4000K  
Beam angle: 24° 36°

Driver gear for LED: Non-Dimmable  
1-10V Dimmable  
DALI Dimmable  
Triac Dimmable

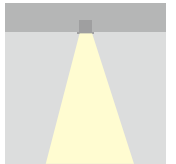

- Housing and mounting ring: Cast aluminum.
- Light source: COB LED with a lens of optical.
- Reflector: Aluminum bright anodised.
- The light can be compatible with emergency battery.

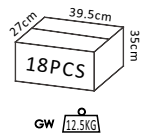
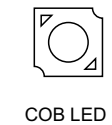
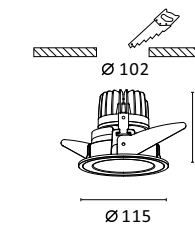

R6172 6W 580lm  
With LED Driver 36V-135mA  
230V-50Hz

NW  
0.37kg

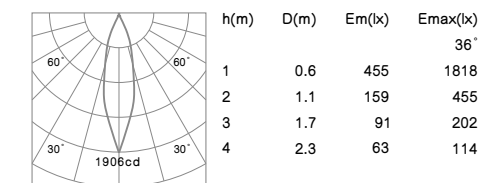
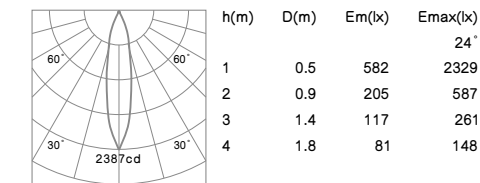

R6172 10W 980lm  
With LED Driver 36V-250mA  
230V-50Hz

NW  
0.37kg

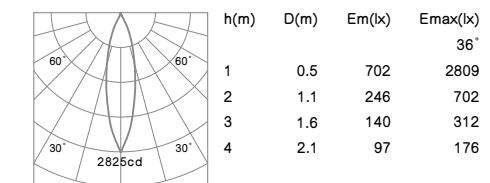
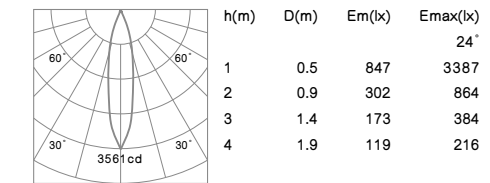



# TINA s



**COB LED CRI≥80 IP44 CE RoHS**

Reflector Color:  RM  RG

Mounting frame color: White Silver Black  
 Color temperature: 2700K 3000K 4000K  
 Beam angle: 24° 36°

Driver gear for LED: Non-Dimmable  
 1-10V Dimmable  
 DALI Dimmable  
 Triac Dimmable

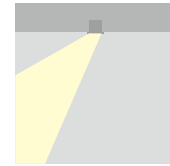

- Housing and mounting ring: Cast aluminum.
- The spot light tilts to a maximum of 0°-30° onto the vertical plane and rotates by 358° onto the horizontal plane.
- Light source: COB LED with a lens of optical.
- Reflector: Aluminum bright anodised.
- The light can be compatible with emergency battery.

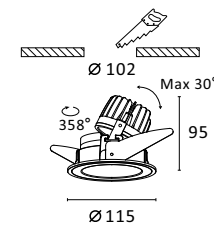

COB LED

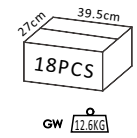

**R6173 6W 580lm**  
 With LED Driver 36V-135mA  
 230V-50Hz

NW  
 0,48kg

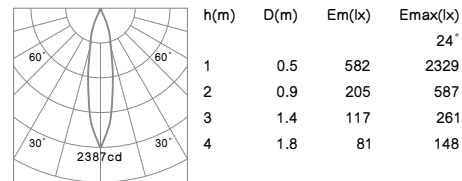

**R6173 10W 980lm**  
 With LED Driver 36V-250mA  
 230V-50Hz

NW  
 0,48kg

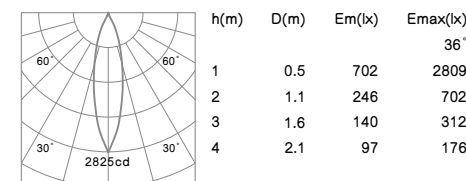
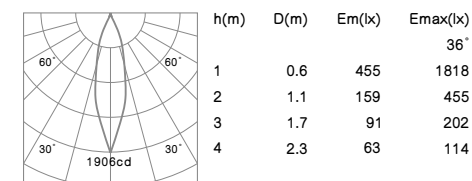
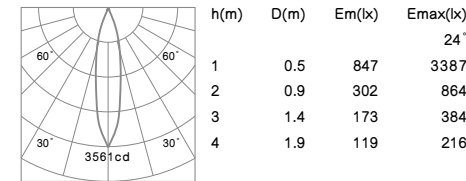

# TINA s



**COB LED CRI≥80 IP44 CE RoHS**

Reflector Color:  RM  RG

Mounting frame color: White Silver Black  
 Color temperature: 2700K 3000K 4000K  
 Beam angle: 24° 36°

Driver gear for LED: Non-Dimmable  
 1-10V Dimmable  
 DALI Dimmable  
 Triac Dimmable

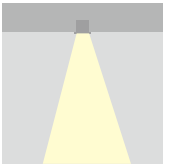

- Housing and mounting ring: Cast aluminum.
- Light source: COB LED with a lens of optical.
- Reflector: Aluminum bright anodised.
- The light can be compatible with emergency battery.

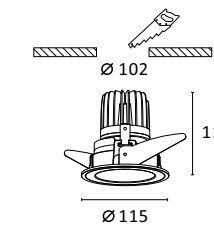

COB LED

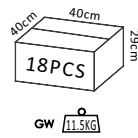

**R6218 15W 1300lm**  
 With LED Driver 36V-350mA  
 230V-50Hz

NW  
 0,44kg

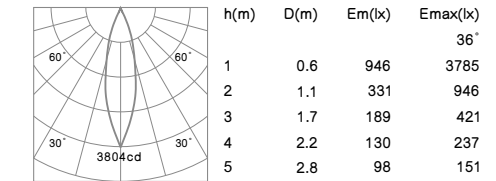
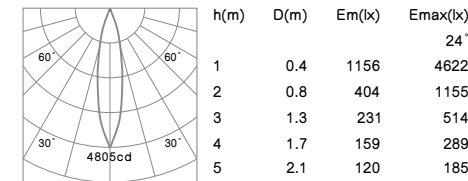

# TINA s



**COB LED CRI≥80 IP44 CE RoHS**

Reflector Color:  RM  RG

Mounting frame color: White Silver Black  
 Color temperature: 2700K 3000K 4000K  
 Beam angle: 24° 36°

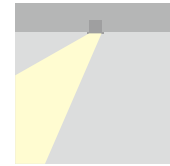

Driver gear for LED: Non-Dimmable  
 1-10V Dimmable  
 DALI Dimmable  
 Triac Dimmable

- Housing and mounting ring: Cast aluminum.
- The spot light tilts to a maximum of 0°-30° onto the vertical plane and rotates by 358° onto the horizontal plane.
- Light source: COB LED with a lens of optical.
- Reflector: Aluminum bright anodised.
- The light can be compatible with emergency battery.

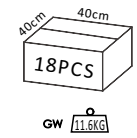
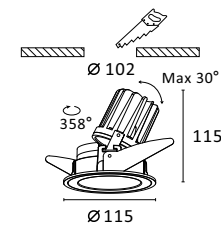

**R6197 15W 1200lm**  
 With LED Driver 36V-350mA  
 230V-50Hz

NW  
 0.48kg

h(m)	D(m)	Em(lx)	Emax(lx)
1	0.4	1156	4622
2	0.8	404	1155
3	1.3	231	514
4	1.7	159	289
5	2.1	120	185

h(m)	D(m)	Em(lx)	Emax(lx)
1	0.6	946	3785
2	1.1	331	946
3	1.7	189	421
4	2.2	130	237
5	2.8	98	151

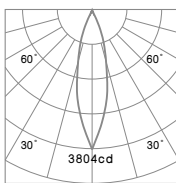

# TINA m



**COB LED CRI≥80 IP44 CE RoHS**

Reflector Color:  RS  RG

Mounting frame color: White Silver Black  
 Color temperature: 2700K 3000K 4000K  
 Beam angle: 24° 36° 60°

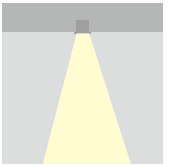

Driver gear for LED: Non-Dimmable  
 1-10V Dimmable  
 DALI Dimmable  
 Triac Dimmable

- Housing and mounting ring: Cast aluminum.
- Light source: COB LED with a high efficiency reflector of optical.
- Darklight reflector: Aluminum satin-matt anodised.
- The light can be compatible with emergency battery.

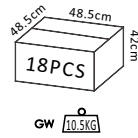
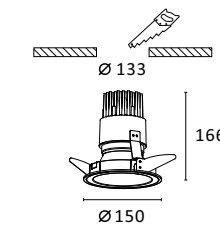

**R6092 15W 1300lm**  
 With LED Driver 36V-350mA  
 230V-50Hz

NW  
 1.01kg

h(m)	D(m)	Em(lx)	Emax(lx)
1	0.6	847	3387
2	1.1	302	864
3	1.7	173	384
4	2.2	119	216
5	2.8	119	216

h(m)	D(m)	Em(lx)	Emax(lx)
1	0.6	585	2339
2	1.2	205	585
3	1.8	117	260
4	2.4	80	146
5	3.0	61	94

h(m)	D(m)	Em(lx)	Emax(lx)
1	0.9	403	1612
2	1.8	141	403
3	2.7	81	179
4	3.6	55	100
5	4.6	42	65

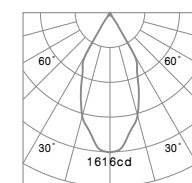

# TINA M

**R6092 20W 1800lm**  
With LED Driver 36V-500mA  
230V-50Hz

NW  
1.01kg

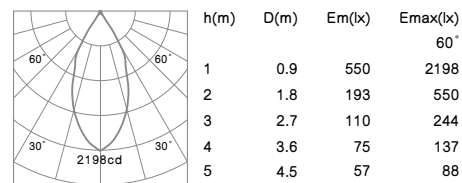
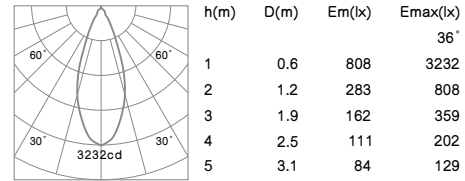
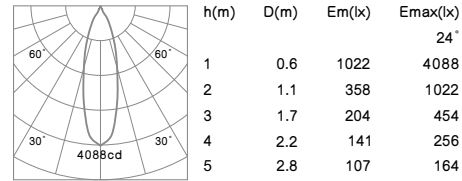

**R6092 25W 2000lm**  
With LED Driver 36V-600mA  
230V-50Hz

NW  
1.01kg

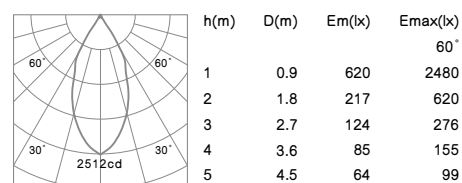
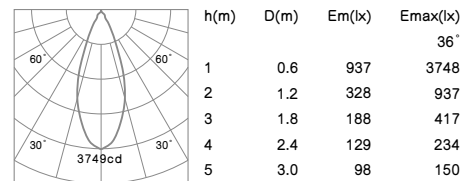
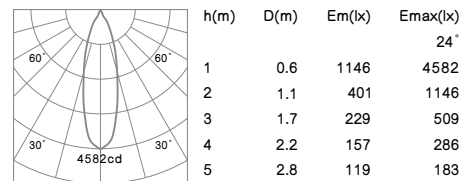

# TINA L



**COB LED** **CRi>80** **IP44** **CE** **RoHS**

Reflector Color: RS RG

Mounting frame color: White Silver Black  
Color temperature: 2700K 3000K 4000K  
Beam angle: 24° 36° 60°

Driver gear for LED: Non-Dimmable  
1-10V Dimmable  
DALI Dimmable  
Triac Dimmable

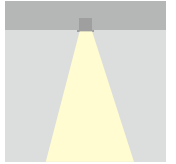

- Housing and mounting ring: Cast aluminum.
- Light source: COB LED with a high efficiency reflector of optical.
- Darklight reflector: Aluminum satin-matt anodised.
- The light can be compatible with emergency battery.

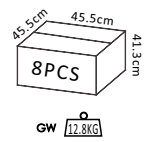
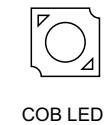
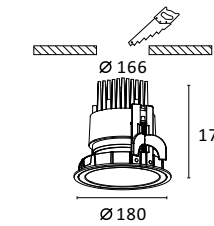

**R6325 20W 2000lm**  
With LED Driver 36V-500mA  
230V-50Hz

NW  
1.51kg

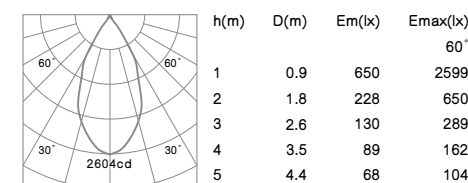
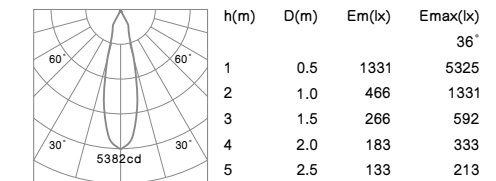
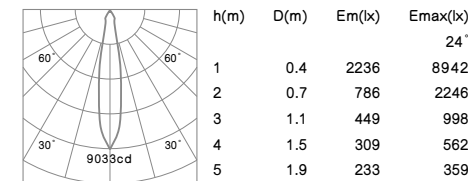





INCO



RD (darklight)

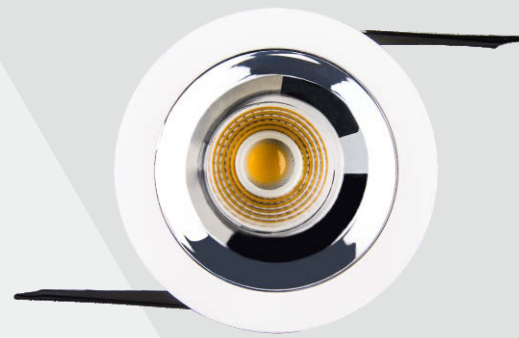

RM (mirror)

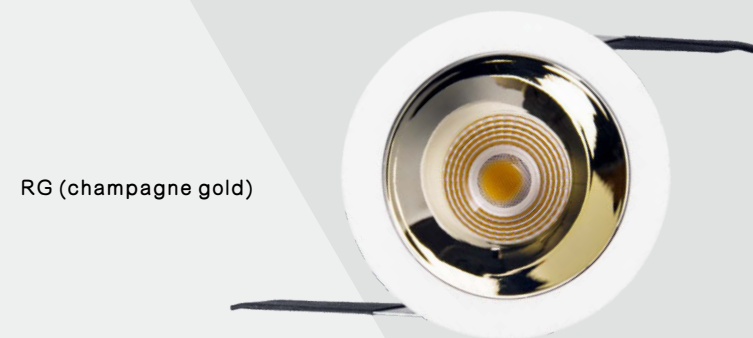

RG (champagne gold)

INCO



Max 30°

•The spot light tilts to a maximum of 0°-30° onto the vertical plane and rotates by 358° onto the horizontal plane.







RM (mirror)



RG (champagne gold)

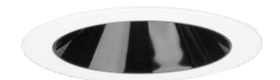

RD (darklight)



Ø 90mm 6W 10W

P169



Ø 90mm 6W 10W

P170



Ø 90mm 15W

P171



Ø 90mm 15W

P172



# INCO



**COB LED CRI≥80 IP44 CE RoHS**

Reflector color:     
RM RG RD

Mounting frame color: White Silver Black  
Color temperature: 2700K 3000K 4000K  
Beam angle: 24° 36°

Driver gear for LED: Non-Dimmable  
1-10V Dimmable  
DALI Dimmable  
Triac Dimmable

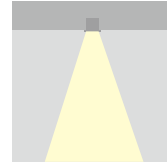

- Housing and mounting ring: Cast aluminum.
- Light source: COB LED with a lens of optical.
- Reflector: Plastic electroplated, black or champagne gold.
- The light can be compatible with emergency battery.

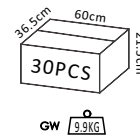
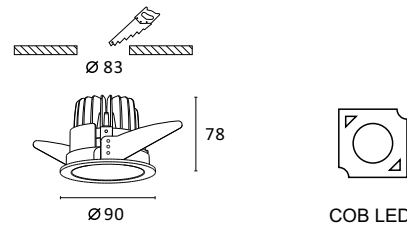

**R6140 6W 450lm**  
With LED Driver 36V-135mA  
230V-50Hz

NW  
0.42kg

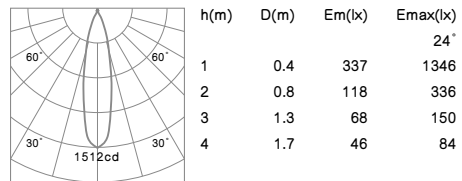

**R6140 10W 800lm**  
With LED Driver 36V-250mA  
230V-50Hz

NW  
0.42kg

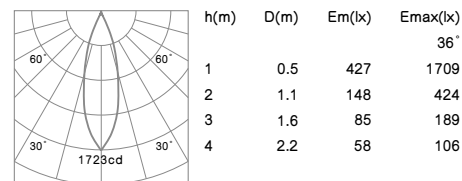
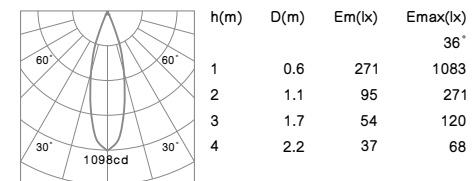
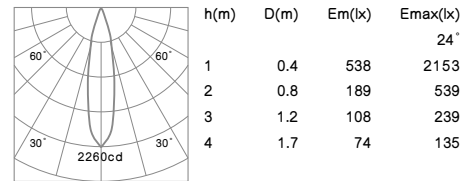

# INCO



**COB LED CRI≥80 IP44 CE RoHS**

Reflector color:     
RM RG RD

Mounting frame color: White Silver Black  
Color temperature: 2700K 3000K 4000K  
Beam angle: 24° 36°

Driver gear for LED: Non-Dimmable  
1-10V Dimmable  
DALI Dimmable  
Triac Dimmable

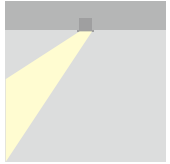

- Housing and mounting ring: Cast aluminum.
- The spot light tilts to a maximum of 0°-30° onto the vertical plane and rotates by 358° onto the horizontal plane.
- Light source: COB LED with a lens of optical.
- Reflector: Plastic electroplated, black or champagne gold.
- The light can be compatible with emergency battery.

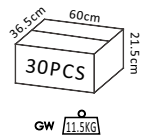
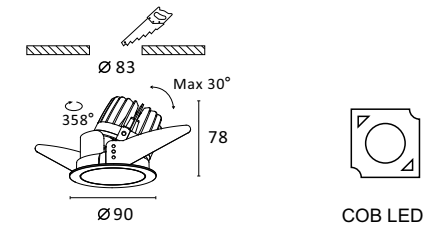

**R6282 6W 450lm**  
With LED Driver 36V-135mA  
230V-50Hz

NW  
0.46kg

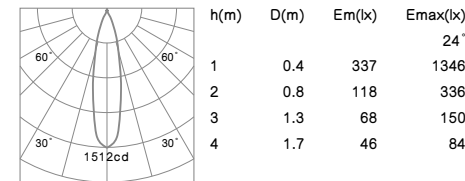

**R6282 10W 800lm**  
With LED Driver 36V-250mA  
230V-50Hz

NW  
0.46kg

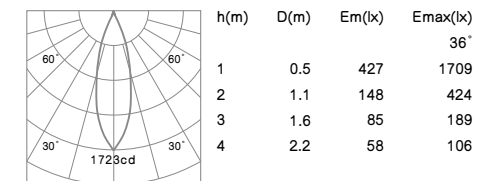
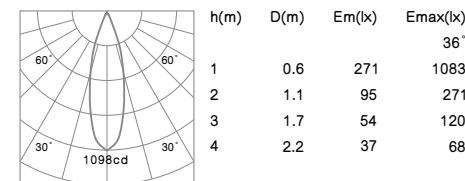
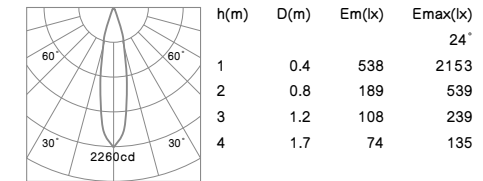

# INCO



**COB LED CRI≥80 IP44 CE RoHS**

Reflector color:

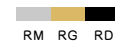

Mounting frame color: White Silver Black  
 Color temperature: 2700K 3000K 4000K  
 Beam angle: 24° 36°

Driver gear for LED: Non-Dimmable  
 1-10V Dimmable  
 DALI Dimmable  
 Triac Dimmable

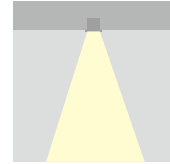

- Housing and mounting ring: Cast aluminum.
- Light source: COB LED with a lens of optical.
- Reflector: Plastic electroplated, black or champagne gold.
- The light can be compatible with emergency battery.

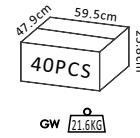
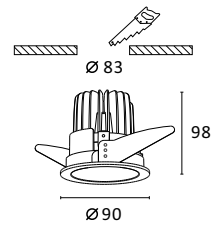

**R6146 15W 1000lm**  
 With LED Driver 36V-350mA  
 230V-50Hz

NW  
 0.49kg

h(m)	D(m)	Em(lx)	E <sub>max</sub> (lx)
1	0.4	848	3391
2	0.8	295	843
3	1.2	169	375
4	1.6	116	211
5	1.9	88	135

h(m)	D(m)	Em(lx)	E <sub>max</sub> (lx)
1	0.5	623	2492
2	1.1	220	628
3	1.6	126	279
4	2.1	86	157
5	2.7	86	101

# INCO



**COB LED CRI≥80 IP44 CE RoHS**

Reflector color:



Mounting frame color: White Silver Black  
 Color temperature: 2700K 3000K 4000K  
 Beam angle: 24° 36°

Driver gear for LED: Non-Dimmable  
 1-10V Dimmable  
 DALI Dimmable  
 Triac Dimmable

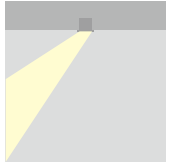

- Housing and mounting ring: Cast aluminum.
- The spot light tilts to a maximum of 0°-30° onto the vertical plane and rotates by 358° onto the horizontal plane.
- Light source: COB LED with a lens of optical.
- Reflector: Plastic electroplated, black or champagne gold.
- The light can be compatible with emergency battery.

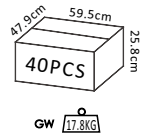
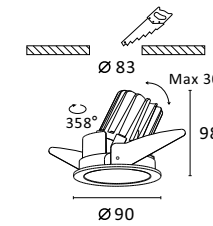

**R6200 15W 1000lm**  
 With LED Driver 36V-350mA  
 230V-50Hz

NW  
 0.46kg

h(m)	D(m)	Em(lx)	E <sub>max</sub> (lx)
1	0.4	848	3391
2	0.8	295	843
3	1.2	169	375
4	1.6	116	211
5	1.9	88	135

h(m)	D(m)	Em(lx)	E <sub>max</sub> (lx)
1	0.5	623	2492
2	1.1	220	628
3	1.6	126	279
4	2.1	86	157
5	2.7	86	101

WATA

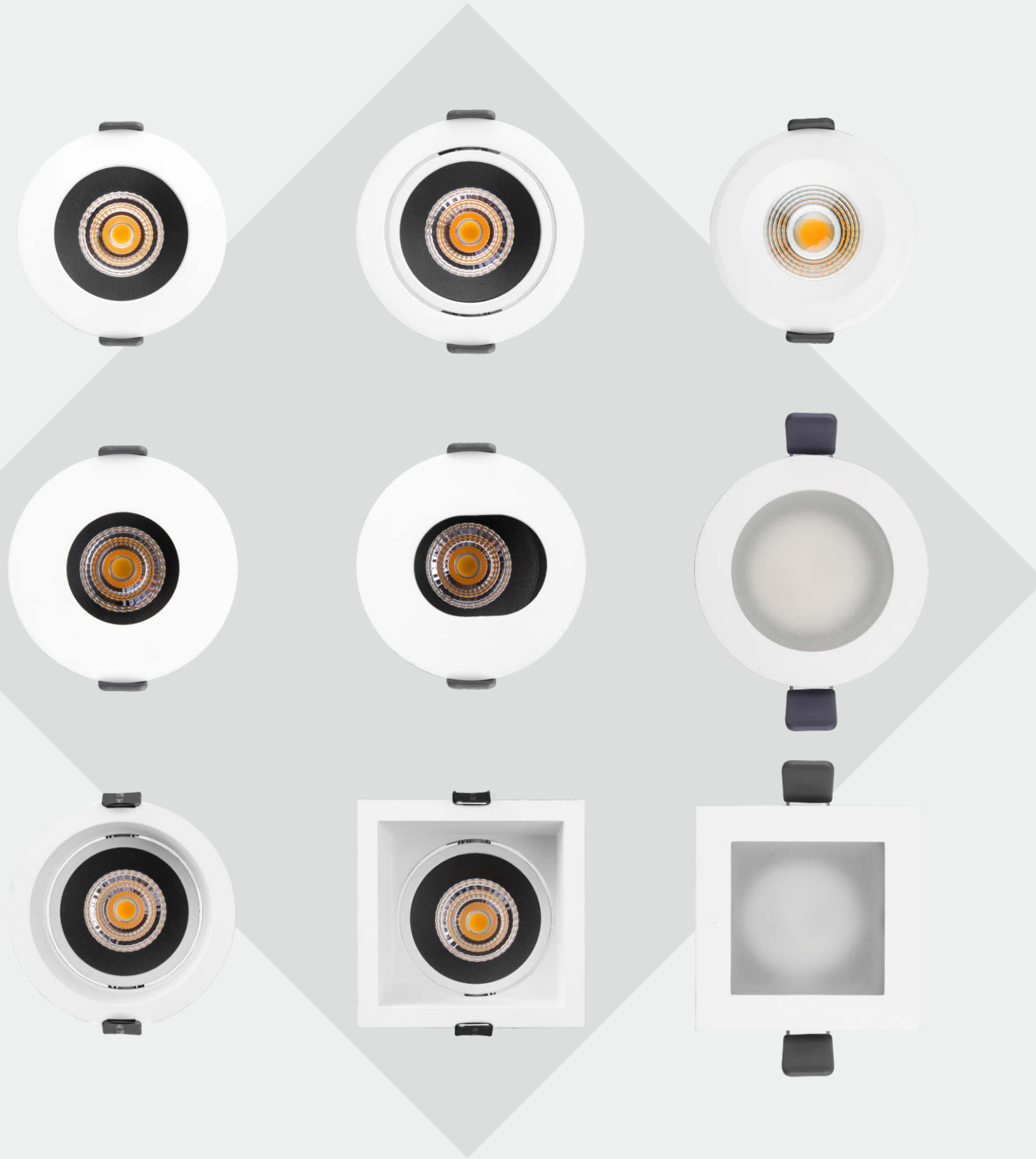

WATA











Ø 87mm 10W

P180



Ø 90mm 10W

P181



Ø 90mm 10W

P182



Ø 90mm 10W

P183



Ø 90mm 10W

P184



□ 90x90mm 10W

P185

# WATA



Ø 80mm

5W

P186



Ø 92mm

6W 10W

P187



□ 89x89mm

6W 10W

P188

# WATA



**COB LED CRI≥80 IP65 CE RoHS**  
 Mounting frame color: White Silver Black  
 Color temperature: 2700K 3000K 4000K  
 Beam angle: 24° 36° 60°

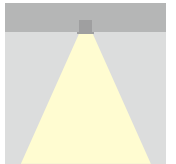

- Housing and Mounting ring: Cast aluminum with anti-rust powder coating process.
- Light source: COB LED with a high efficiency reflector of optical.
- Driver with waterproof box.

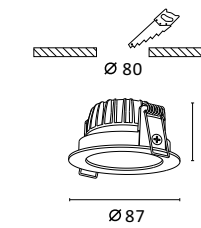

COB LED

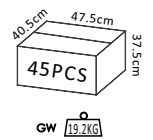

**E6021 10W 1020lm**  
 With LED Driver 36V-250mA  
 230V-50Hz

NW  
 0.30kg

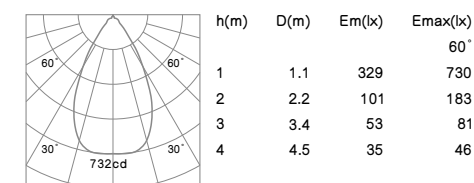
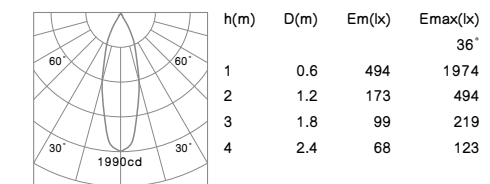
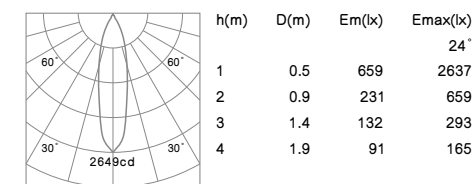



# WATA



**COB LED CRI≥80 IP65 CE RoHS**

Mounting frame color: White Silver Black  
 Color temperature: 2700K 3000K 4000K  
 Beam angle: 24° 36° 60°

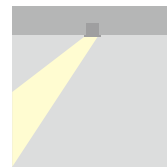

- Housing and Mounting ring: Cast aluminum with anti-rust powder coating process.
- Light source: COB LED with a high efficiency reflector of optical.
- Driver with waterproof box.

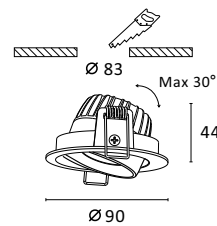

COB LED

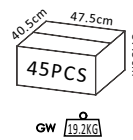

**E6022 10W 1020lm**  
 With LED Driver 36V-250mA  
 230V-50Hz

NW  
 0.30kg

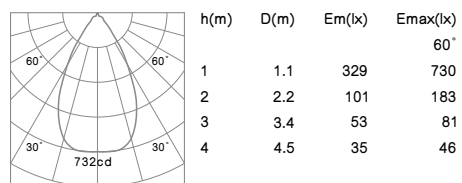
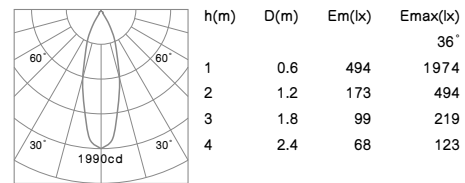
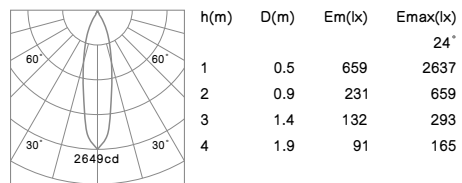

# WATA



**COB LED CRI≥80 IP65 CE RoHS**

Mounting frame color: White Silver Black  
 Color temperature: 2700K 3000K 4000K  
 Beam angle: 24° 36° 60°

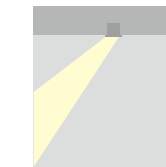

- Housing and Mounting ring: Cast aluminum with anti-rust powder coating process.
- Light source: COB LED with a high efficiency reflector of optical.
- Driver with waterproof box.

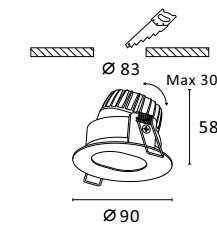

COB LED

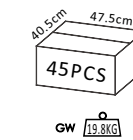

**E6023 10W 740lm**  
 With LED Driver 36V-250mA  
 230V-50Hz

NW  
 0.31kg

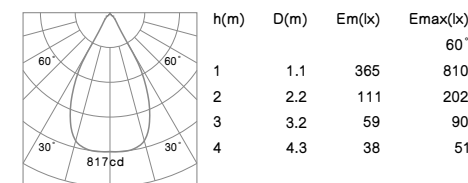
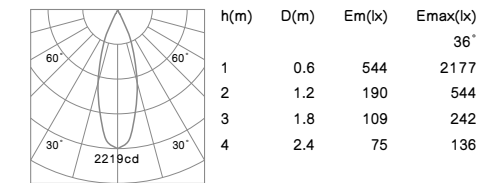
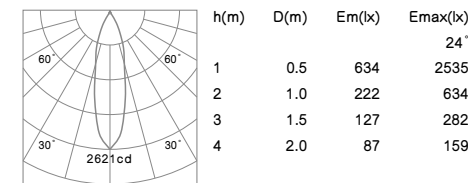

# WATA



**COB LED CRI≥80 IP65 CE RoHS**

Mounting frame color: White Silver Black  
 Color temperature: 2700K 3000K 4000K  
 Beam angle: 24° 36° 60°

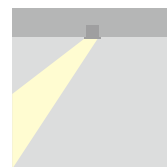

- Housing and Mounting ring: Cast aluminum with anti-rust powder coating process.
- Light source: COB LED with a high efficiency reflector of optical.
- Driver with waterproof box.

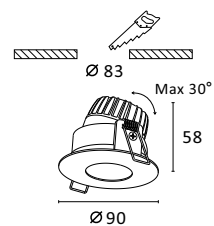

COB LED

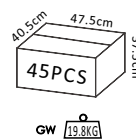

**E6024 10W 720lm**  
 With LED Driver 36V-250mA  
 230V-50Hz

NW  
 0.31kg

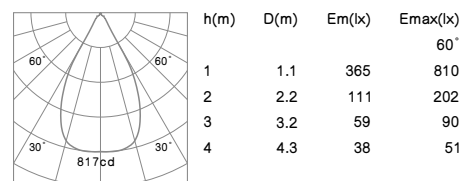
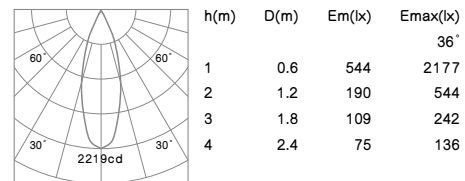
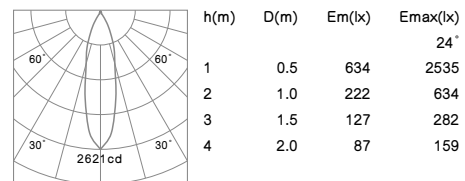

# WATA



**COB LED CRI≥80 IP65 CE RoHS**

Mounting frame color: White Silver Black  
 Color temperature: 2700K 3000K 4000K  
 Beam angle: 24° 36° 60°

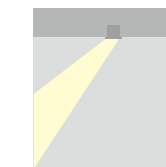

- Housing and Mounting ring: Cast aluminum with anti-rust powder coating process.
- Light source: COB LED with a high efficiency reflector of optical.
- Driver with waterproof box.

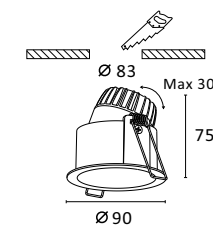

COB LED

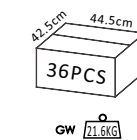

**E6025 10W 1009lm**  
 With LED Driver 36V-250mA  
 230V-50Hz

NW  
 0.34kg

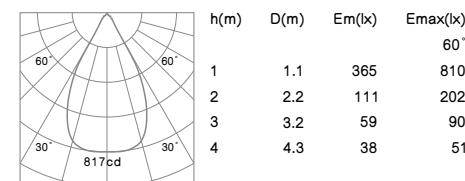
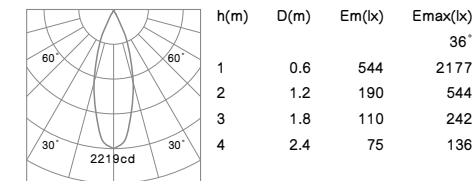
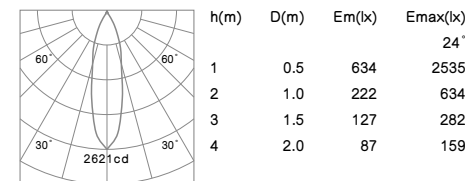

# WATA



**COB LED CRI≥80 IP65 CE RoHS**  
 Mounting frame color: White Silver Black  
 Color temperature: 2700K 3000K 4000K  
 Beam angle: 24° 36° 60°

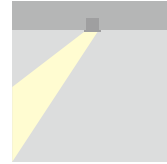

- Housing and Mounting ring: Cast aluminum with anti-rust powder coating process.
- Light source: COB LED with a high efficiency reflector of optical.
- Driver with waterproof box.

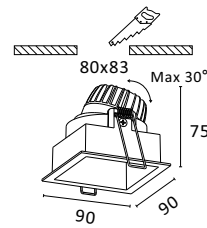

COB LED

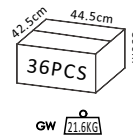

**E6026 10W 1050lm**  
 With LED Driver 36V-250mA  
 230V-50Hz

NW  
 0.34kg

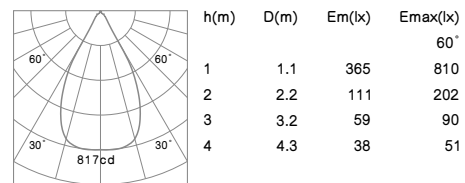
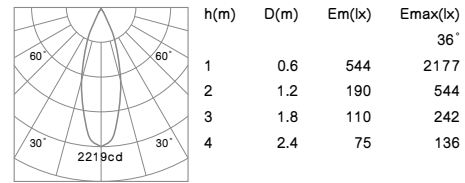
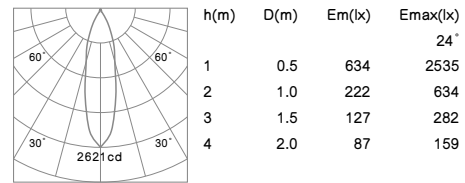

# WATA



**COB LED CRI≥80 IP54 CE RoHS**  
 Mounting frame color: White Silver Black  
 Color temperature: 2700K 3000K 4000K  
 Beam angle: 24° 36° 60°

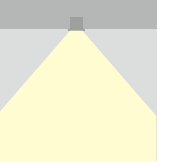

- Housing and mounting ring: Cast aluminum with anti-rust powder coating process.
- Light source: COB LED with a lens of optical.
- Driver with waterproof box.

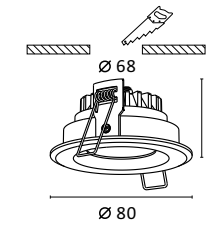

COB LED

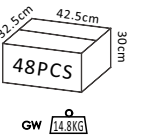

**R6821 5W 428lm**  
 With LED Driver 9V-350mA  
 230V-50Hz

NW  
 0.21kg

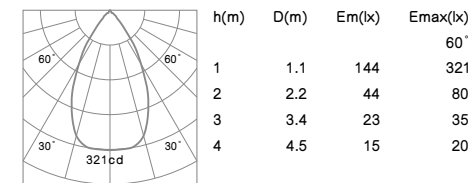
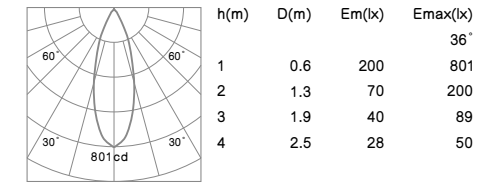
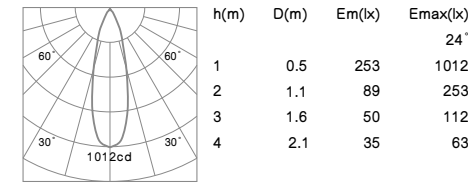



# WATA



**COB LED CRI≥80 IP54 CE RoHS**  
 Mounting frame color: White Silver Black  
 Color temperature: 2700K 3000K 4000K  
 Beam angle: 24° 36° 60°

Driver gear for LED:  
 Non-Dimmable  
 1-10V Dimmable  
 DALI Dimmable  
 Triac Dimmable

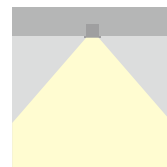

•Housing and mounting ring: Cast aluminum.  
 •Light source: COB LED with optical lens glass and frosted glass.

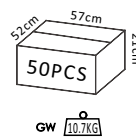
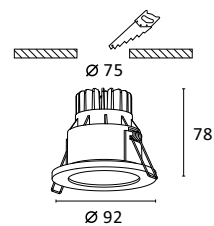

**R6865 6W 574lm**  
 With LED Driver 36V-135mA  
 230V-50Hz

NW  
 0.29kg

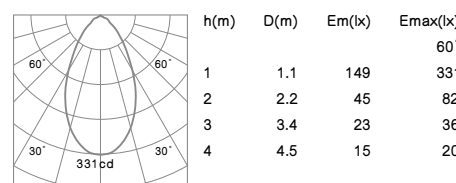
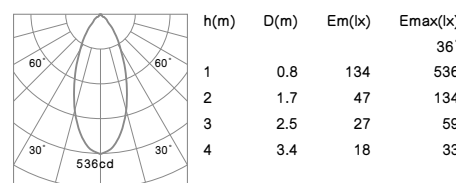
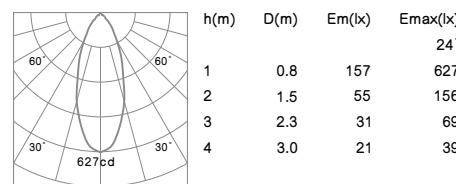

**R6865 10W 996lm**  
 With LED Driver 36V-250mA  
 230V-50Hz

NW  
 0.29kg

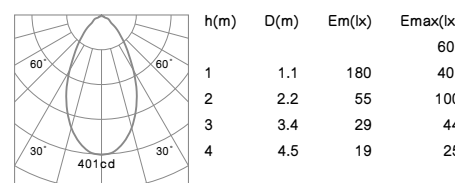
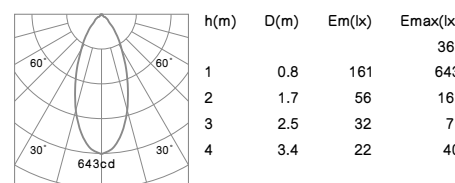
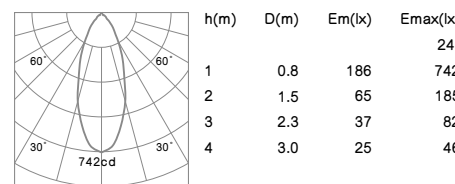

# WATA



**COB LED CRI≥80 IP54 CE RoHS**  
 Mounting frame color: White Silver Black  
 Color temperature: 2700K 3000K 4000K  
 Beam angle: 24° 36° 60°

Driver gear for LED:  
 Non-Dimmable  
 1-10V Dimmable  
 DALI Dimmable  
 Triac Dimmable

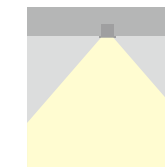

•Housing and mounting ring: Cast aluminum.  
 •Light source: COB LED with optical lens glass and frosted glass.

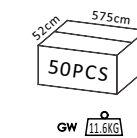
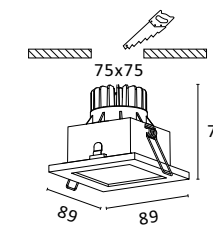

**R6864 6W 538lm**  
 With LED Driver 36V-135mA  
 230V-50Hz

NW  
 0.32kg

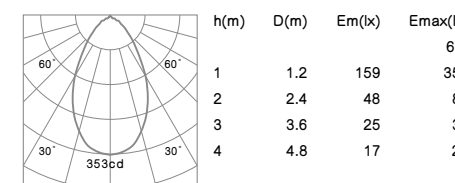
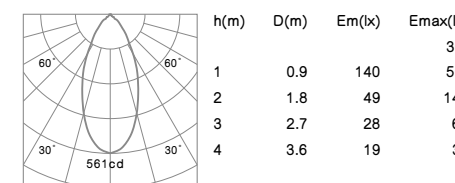
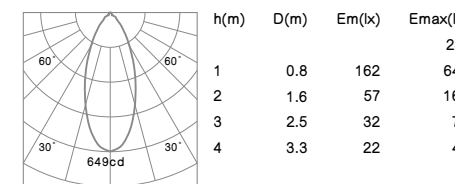

**R6864 10W 941lm**  
 With LED Driver 36V-250mA  
 230V-50Hz

NW  
 0.32kg

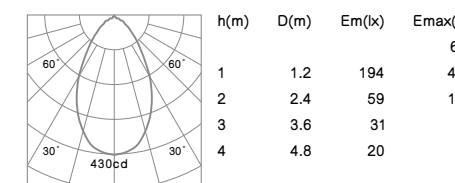
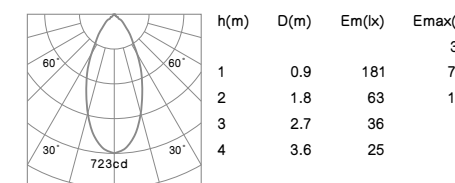
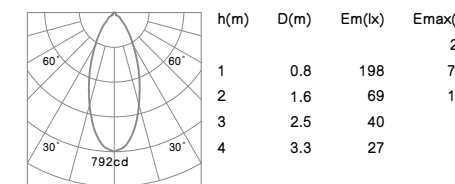

PODO

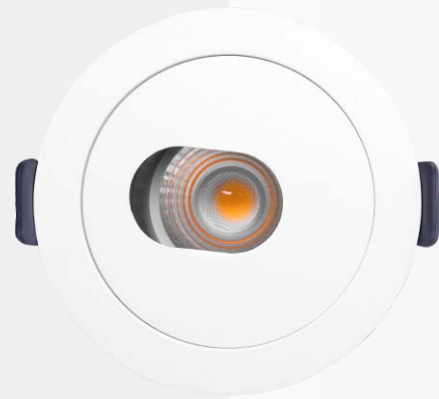

Adjustable

**Pin-hole frame**

Pin-hole frame can improve the anti-dazzle effect of lamps.



Fixed

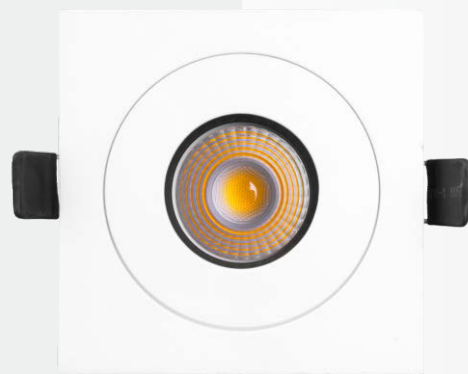

Adjustable

189

PODO

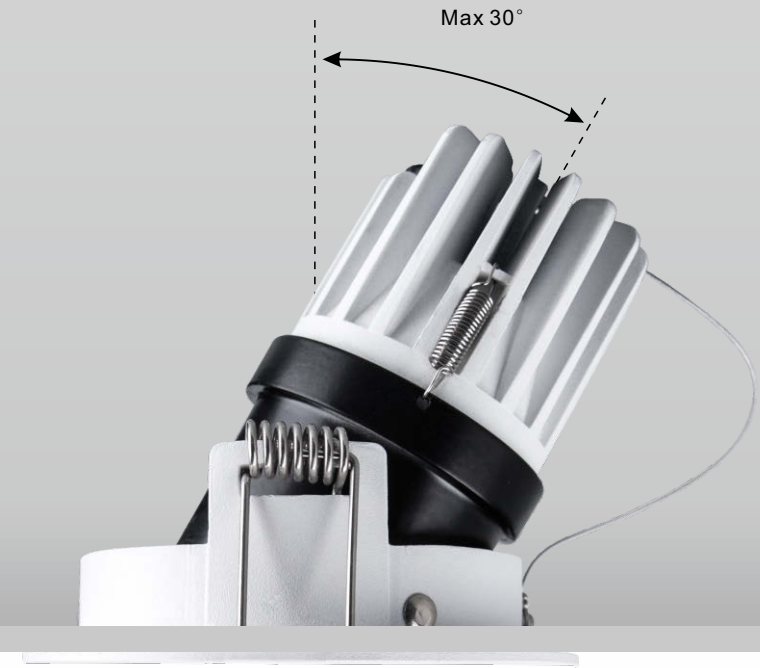

The spot light tilts to a maximum of 0°-30° onto the vertical plane and rotates by 358° onto the horizontal plane.

Anti-dazzle ring: Aluminum black.

190

PODO

PODO





# PODO



Ø 85mm

6W 10W

P194



Ø 95mm

6W 10W

P195



□ 95x95mm

6W 10W

P196

# PODO



**COB LED CRI≥80 IP20 CE RoHS**  
 Mounting frame color: White Silver Black  
 Color temperature: 2700K 3000K 4000K  
 Beam angle: 24° 36°

Driver gear for LED:  
 Non-Dimmable  
 1-10V Dimmable  
 DALI Dimmable  
 Triac Dimmable

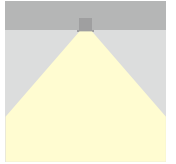

- Housing and mounting ring: Cast aluminum.
- Light source: COB LED with a high efficiency reflector of optical.
- Anti-dazzle ring: Aluminum black.

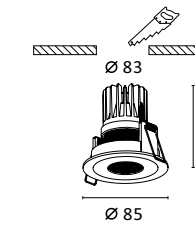

COB LED

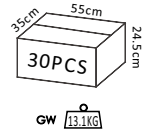

**R6335 6W 288lm**  
 With LED Driver 36V-135mA  
 230V-50Hz

NW  
 0.37kg

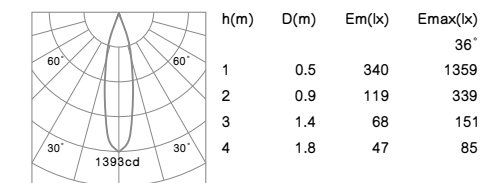
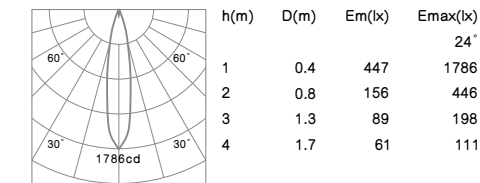

**R6335 10W 506lm**  
 With LED Driver 36V-250mA  
 230V-50Hz

NW  
 0.37kg

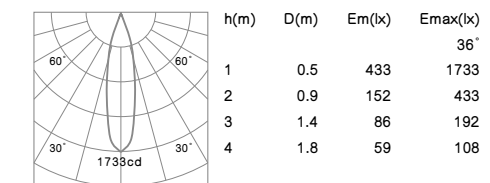
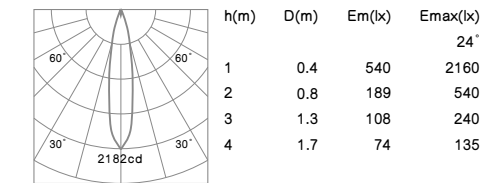

# PODO



<b>COB LED</b>	<b>CRI≥80</b>	<b>IP20</b>	<b>CE</b>	<b>RoHS</b>
Mounting frame color:	White	Silver	Black	
Color temperature:	2700K	3000K	4000K	
Beam angle:	24°	36°		

Driver gear for LED:

- Non-Dimmable
- 1-10V Dimmable
- DALI Dimmable
- Triac Dimmable

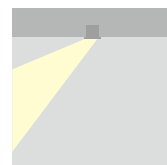

- Housing and mounting ring: Cast aluminum.
- The spot light tilts to a maximum of 0°-30° onto the vertical plane and rotates by 358° onto the horizontal plane.
- Light source: COB LED with a lens of optical.
- Anti-dazzle ring: Aluminum black.
- The light can be compatible with emergency battery.

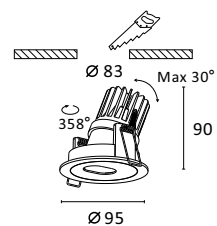

COB LED

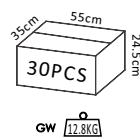

**R6334 6W 197lm**  
With LED Driver 36V-135mA  
230V-50Hz

NW  
0.36kg

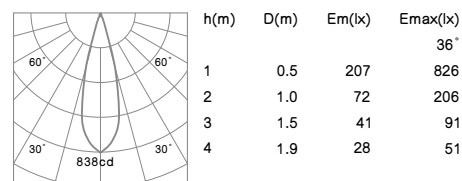
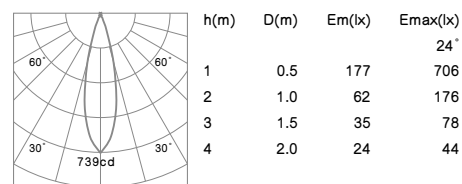

**R6334 10W 355lm**  
With LED Driver 36V-250mA  
230V-50Hz

NW  
0.36kg

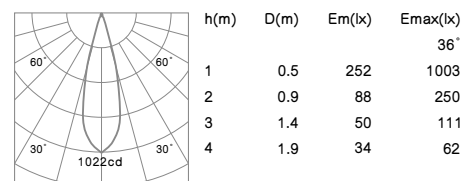
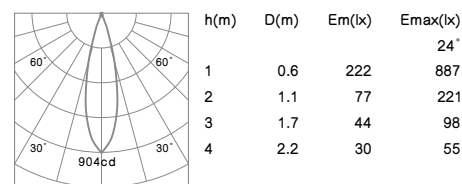

# PODO



<b>COB LED</b>	<b>CRI≥80</b>	<b>IP20</b>	<b>CE</b>	<b>RoHS</b>
Mounting frame color:	White	Silver	Black	
Color temperature:	2700K	3000K	4000K	
Beam angle:	24°	36°	60°	

Driver gear for LED:

- Non-Dimmable
- 1-10V Dimmable
- DALI Dimmable
- Triac Dimmable

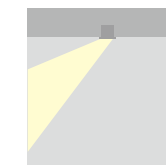

- Housing and mounting ring: Cast aluminum.
- The spot light tilts to a maximum of 0°-30° onto the vertical plane and rotates by 358° onto the horizontal plane.
- Light source: COB LED with a lens or a high efficiency reflector of optical.
- Anti-dazzle ring: Aluminum black.

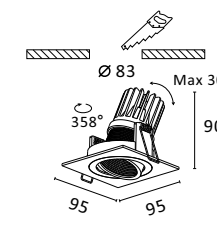

COB LED

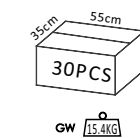

**R6319 6W 360lm**  
With LED Driver 36V-135mA  
230V-50Hz

NW  
0.36kg

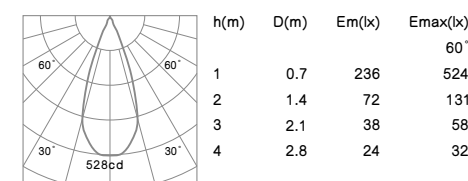
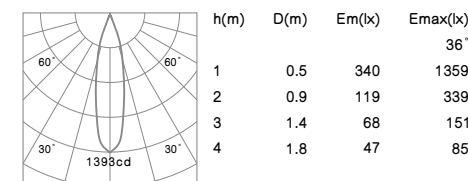
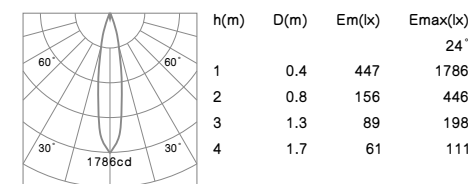

**R6319 10W 623lm**  
With LED Driver 36V-250mA  
230V-50Hz

NW  
0.36kg

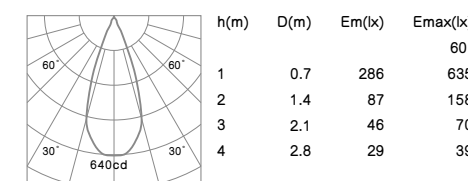
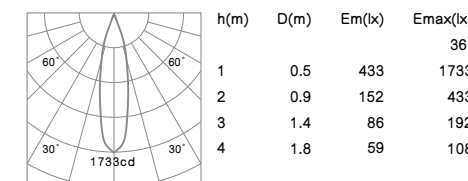
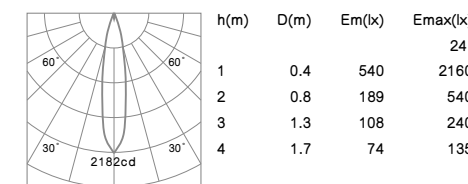

ROSU

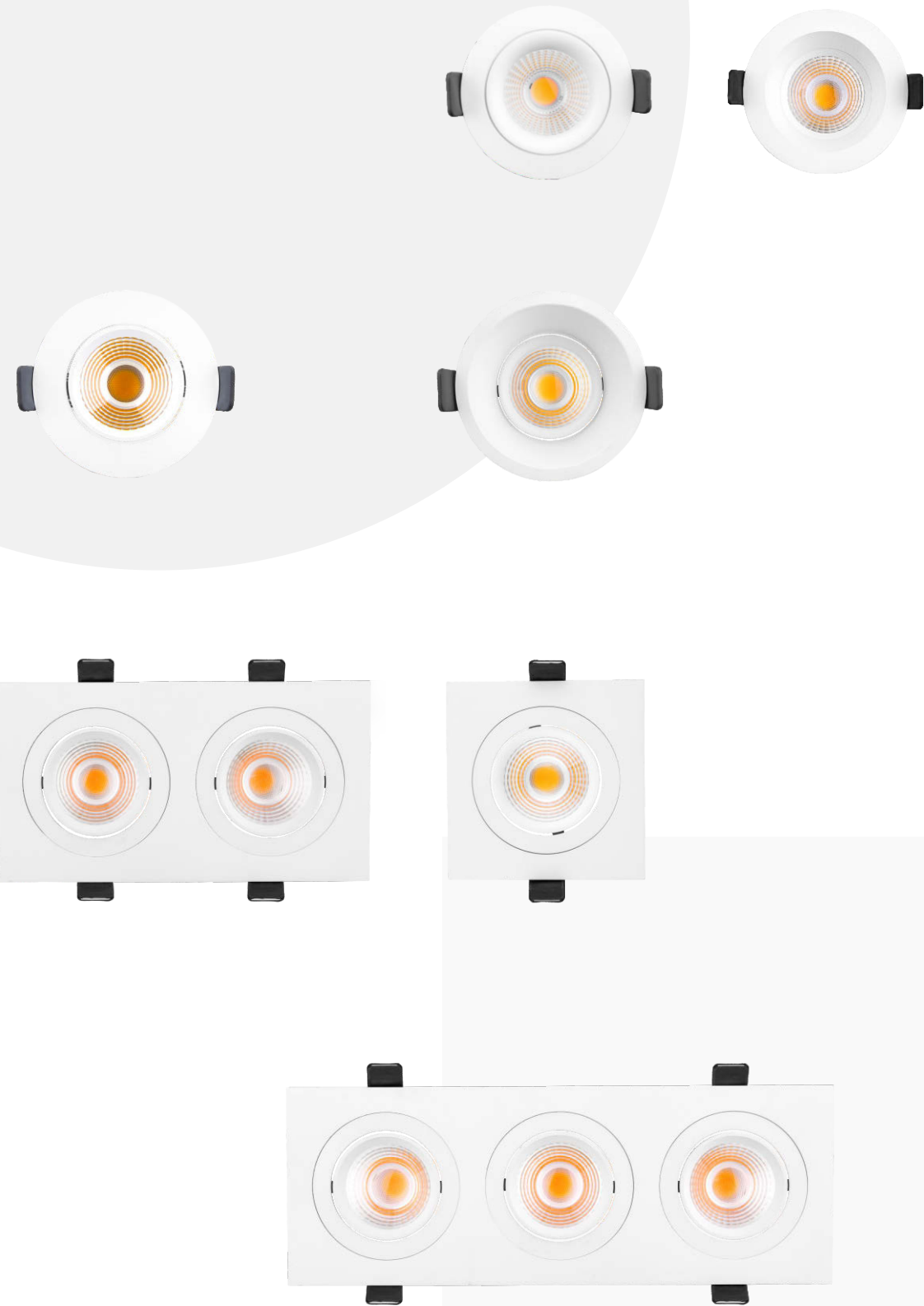

197

ROSU

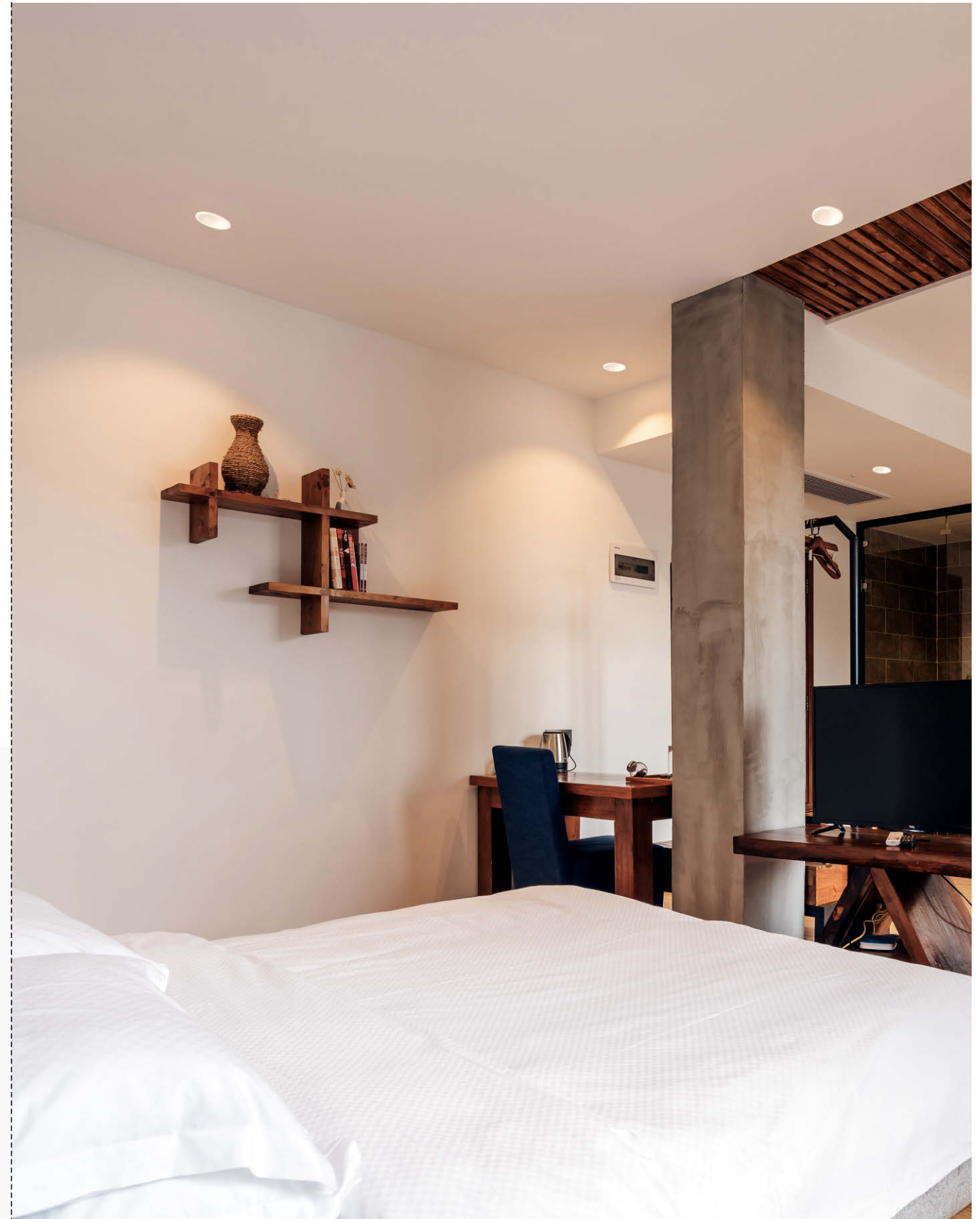









198









ROSU



ROSU

	Ø 80mm	6W 10W	P202
	Ø 80mm	6W 10W	P203
	Ø 92mm	6W 10W	P204
	□ 80x80mm	6W 10W	P205
	□ 80x80mm	6W 10W	P206
	□ 92x92mm	6W 10W	P207
	□ 92x172mm	6W 10W	P209
	□ 92x252mm	6W 10W	P210

# ROSU

	Ø 80mm	6W 10W	P211
	Ø 80mm	6W 10W	P212
	Ø 85mm	6W 10W	P213
	Ø 85mm	6W 10W	P214
	□ 80x80mm	6W 10W	P215
	□ 80x80mm	6W 10W	P216

# ROSU



**COB LED** **CR1≥80** **IP44** **CE** **RoHS**  
 Mounting frame color: White Silver Black  
 Color temperature: 2700K 3000K 4000K  
 Beam angle: 24° 36° 60°

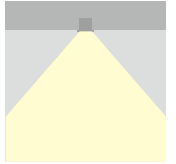

Driver gear for LED:  
 Non-Dimmable  
 1-10V Dimmable  
 DALI Dimmable  
 Triac Dimmable

•Housing: Cast aluminum.  
 •Light source: COB LED with a lens of optical.

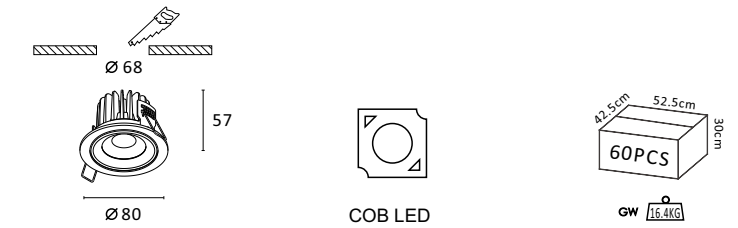

**R6256 6W 703lm**  
 With LED Driver 36V-135mA  
 230V-50Hz

NW  
 0.24kg

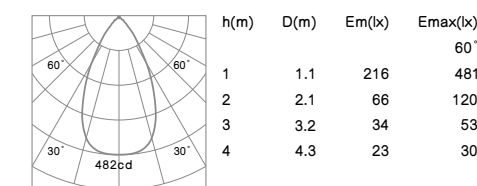
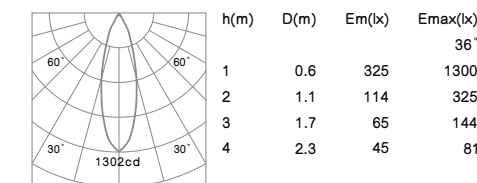
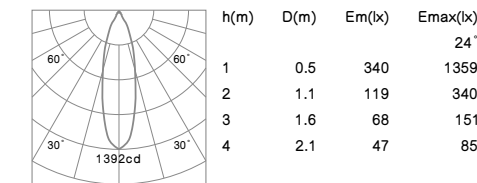

**R6256 10W 1199lm**  
 With LED Driver 36V-250mA  
 230V-50Hz

NW  
 0.24kg

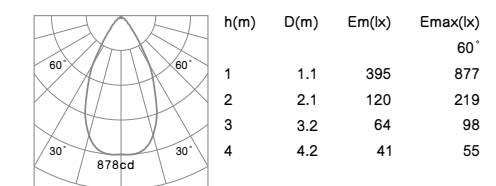
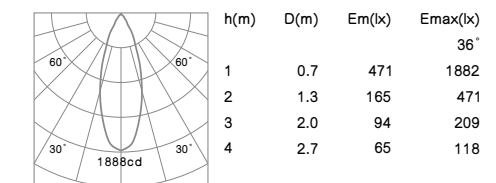
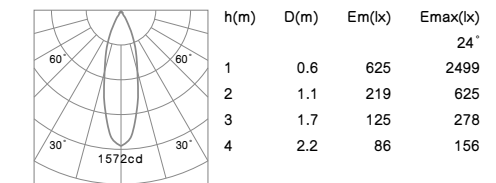

# ROSU



**COB LED** **CRI≥80** **IP44** **CE** **RoHS**  
 Mounting frame color: White Silver Black  
 Color temperature: 2700K 3000K 4000K  
 Beam angle: 24° 36° 60°

Driver gear for LED:  
 Non-Dimmable  
 1-10V Dimmable  
 DALI Dimmable  
 Triac Dimmable

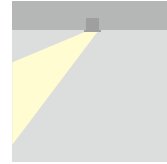

- Housing: Cast aluminum.
- The down light tilts to a maximum of 0°-30° onto the vertical plane.
- Light source: COB LED with a lens of optical.

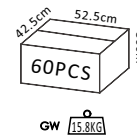
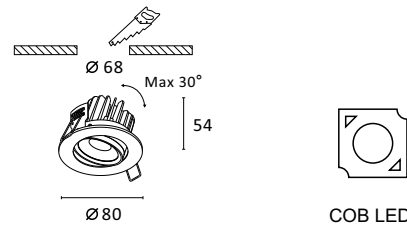

**R6249 6W 703lm**  
 With LED Driver 36V-135mA  
 230V-50Hz

NW  
 0.23kg

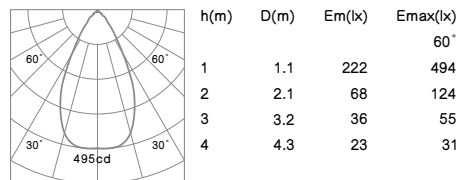
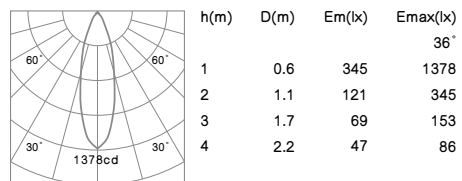
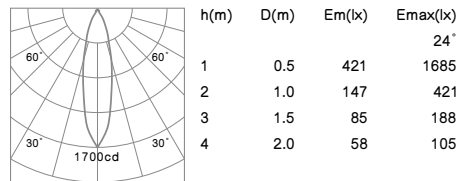

**R6249 10W 1199lm**  
 With LED Driver 36V-250mA  
 230V-50Hz

NW  
 0.23kg

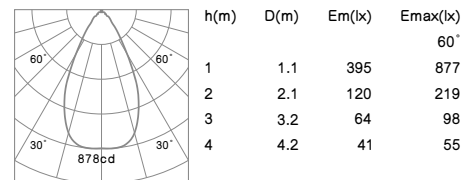
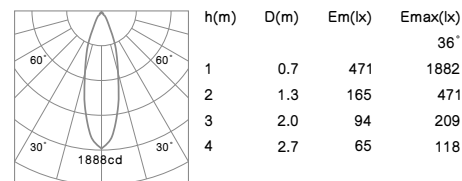
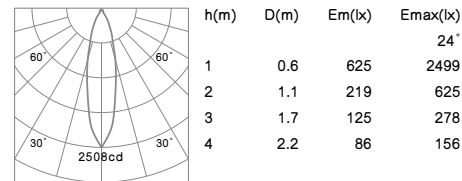

# ROSU



**COB LED** **CRI≥80** **IP44** **CE** **RoHS**  
 Mounting frame color: White Silver Black  
 Color temperature: 2700K 3000K 4000K  
 Beam angle: 24° 36° 60°

Driver gear for LED:  
 Non-Dimmable  
 1-10V Dimmable  
 DALI Dimmable  
 Triac Dimmable

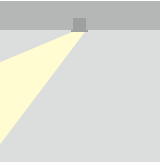

- Housing: Pure aluminum.
- The spot light tilts to a maximum of 0°-30° onto the vertical plane and rotates by 358° onto the horizontal plane.
- Light source: COB LED with a lens of optical.

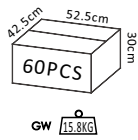
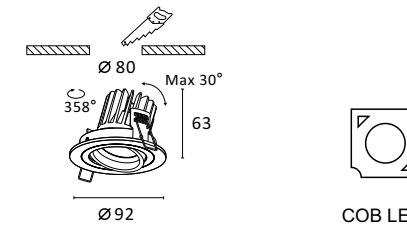

**R6190 6W 703lm**  
 With LED Driver 36V-135mA  
 230V-50Hz

NW  
 0.36kg

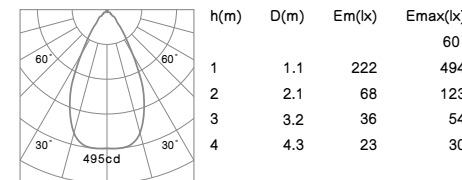
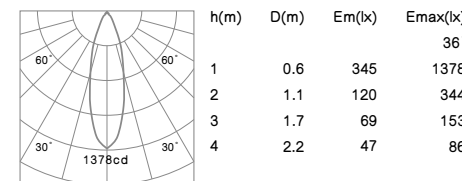
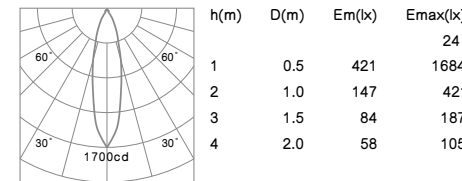

**R6190 10W 1199lm**  
 With LED Driver 36V-250mA  
 230V-50Hz

NW  
 0.36kg

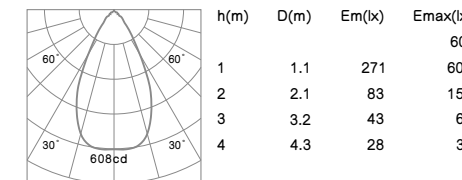
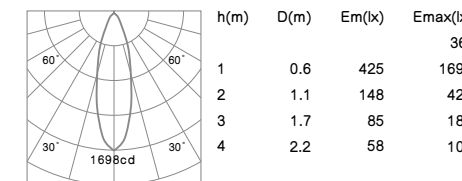
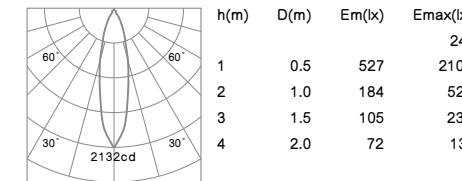



# ROSU



**COB LED CRI≥80 IP44 CE RoHS**  
 Mounting frame color: White Silver Black  
 Color temperature: 2700K 3000K 4000K  
 Beam angle: 24° 36° 60°

Driver gear for LED:  
 Non-Dimmable  
 1-10V Dimmable  
 DALI Dimmable  
 Triac Dimmable

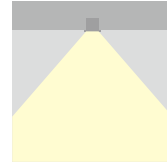

- Housing: Cast aluminum.
- Light source: COB LED with a lens of optical.

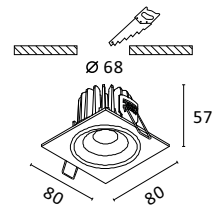

COB LED

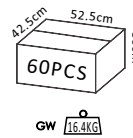

**R6314 6W 703lm**  
 With LED Driver 36V-135mA  
 230V-50Hz

NW  
 0.24kg

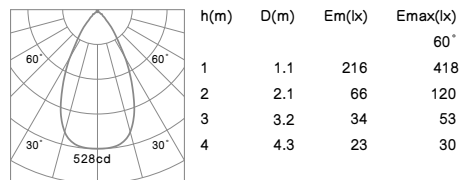
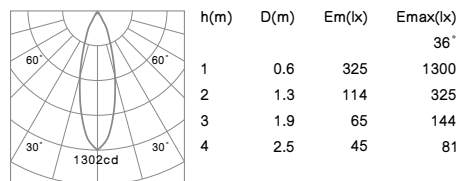
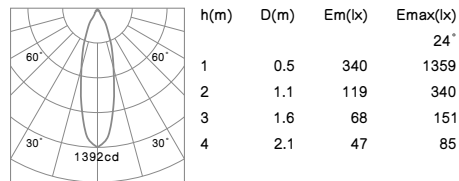

**R6314 10W 1199lm**  
 With LED Driver 36V-250mA  
 230V-50Hz

NW  
 0.24kg

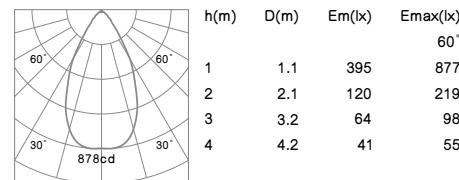
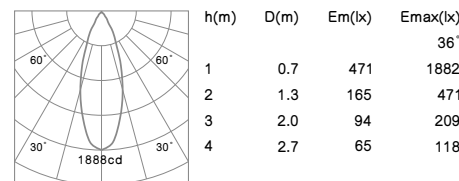
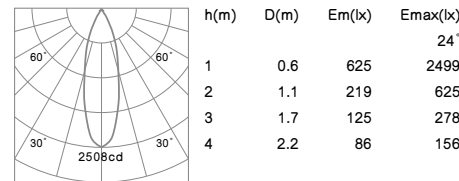

# ROSU



**COB LED CRI≥80 IP44 CE RoHS**  
 Mounting frame color: White Silver Black  
 Color temperature: 2700K 3000K 4000K  
 Beam angle: 24° 36° 60°

Driver gear for LED:  
 Non-Dimmable  
 1-10V Dimmable  
 DALI Dimmable  
 Triac Dimmable

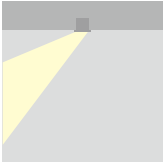

- Housing: Cast aluminum.
- The down light tilts to a maximum of 0°-30° onto the vertical plane.
- Light source: COB LED with a lens of optical.

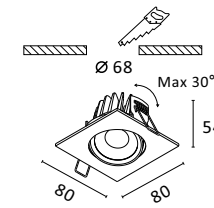

COB LED

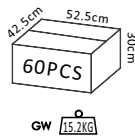

**R6259 6W 703lm**  
 With LED Driver 36V-135mA  
 230V-50Hz

NW  
 0.22kg

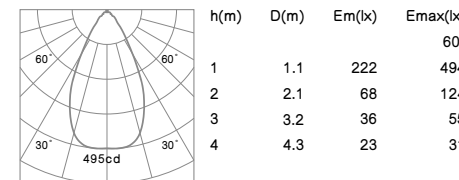
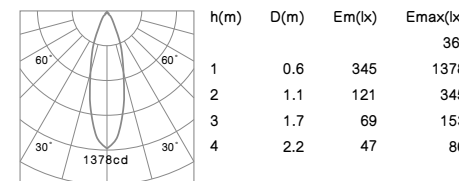
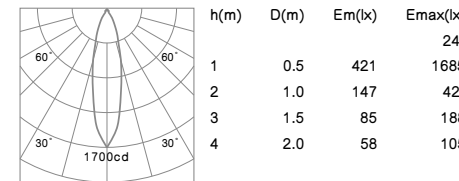

**R6259 10W 1199lm**  
 With LED Driver 36V-250mA  
 230V-50Hz

NW  
 0.22kg

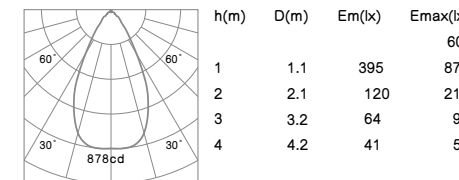
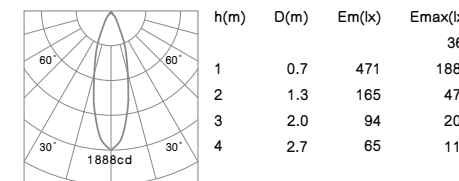
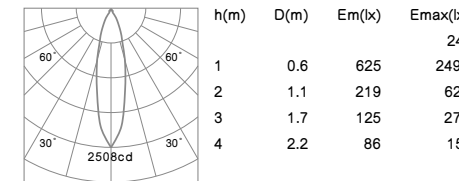

# ROSU



**COB LED CRI≥80 IP44 CE RoHS**  
 Mounting frame color: White Brush Black  
 Color temperature: 2700K 3000K 4000K  
 Beam angle: 24° 36° 60°

Driver gear for LED:  
 Non-Dimmable  
 1-10V Dimmable  
 DALI Dimmable  
 Triac Dimmable

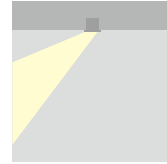

- Housing: Pure aluminum.
- The down light tilts to a maximum of 0°-30° onto the vertical plane and rotates by 358° onto the horizontal plane.
- Light source: COB LED with a lens or a high efficiency reflector of optical.

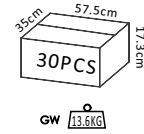
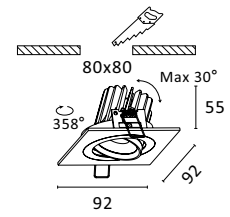

**R6121 6W 703lm**  
 With LED Driver 36V-135mA  
 230V-50Hz

NW  
 0.74kg

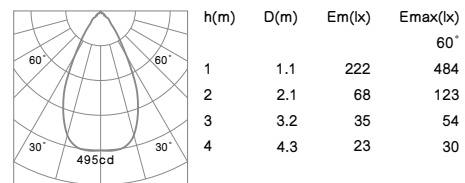
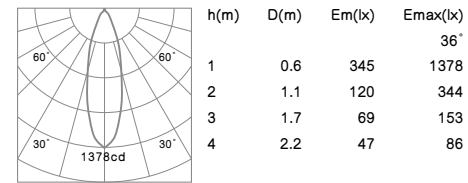
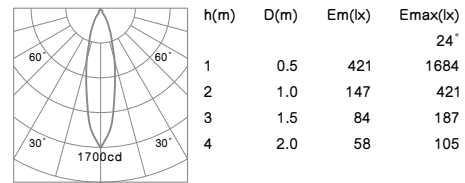

# ROSU

**R6121 10W 1199lm**  
 With LED Driver 36V-250mA  
 230V-50Hz

NW  
 0.74kg

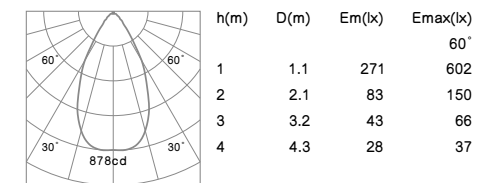
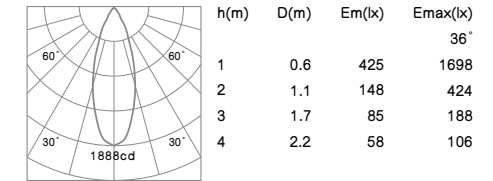
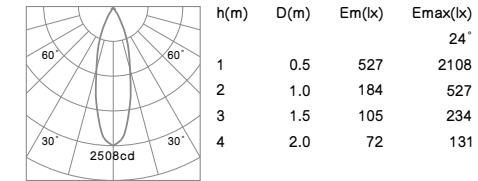

# ROSU



**COB LED CRI≥80 IP44 CE RoHS**  
 Mounting frame color: White Brush Black  
 Color temperature: 2700K 3000K 4000K  
 Beam angle: 24° 36° 60°

Driver gear for LED:  
 Non-Dimmable  
 1-10V Dimmable  
 DALI Dimmable  
 Triac Dimmable

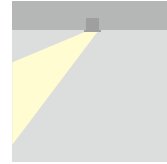

- Housing: Pure aluminum.
- The down light tilts to a maximum of 0°-30° onto the vertical plane and rotates by 358° onto the horizontal plane.
- Light source: COB LED with a lens or a high efficiency reflector of optical.

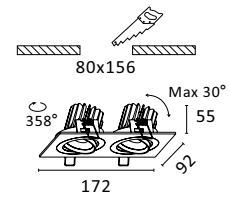

COB LED

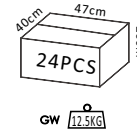

GW 12.5KG

**R6141 2x6W 1400lm**  
 With LED Driver 36V-135mA  
 230V-50Hz

NW  
 1.33kg

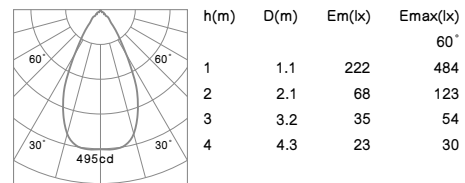
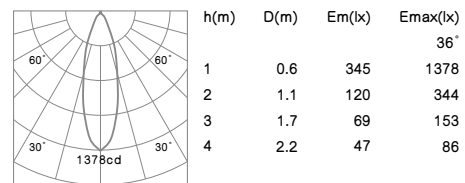
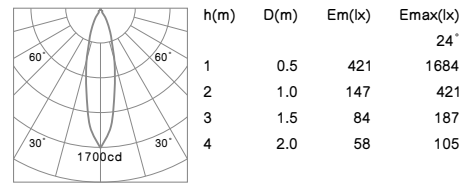

**R6141 2x10W 2400lm**  
 With LED Driver 36V-250mA  
 230V-50Hz

NW  
 1.33kg

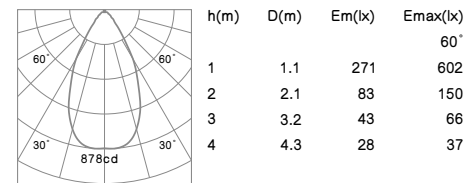
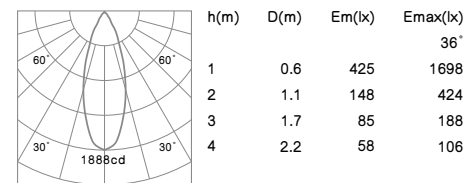
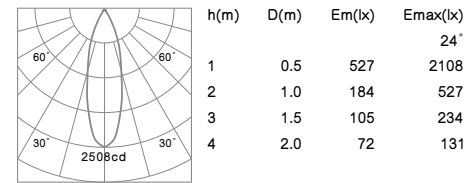

# ROSU



**COB LED CRI≥80 IP44 CE RoHS**  
 Mounting frame color: White Brush Black  
 Color temperature: 2700K 3000K 4000K  
 Beam angle: 24° 36° 60°

Driver gear for LED:  
 Non-Dimmable  
 1-10V Dimmable  
 DALI Dimmable  
 Triac Dimmable

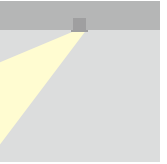

- Housing: Pure aluminum.
- The down light tilts to a maximum of 0°-30° onto the vertical plane and rotates by 358° onto the horizontal plane.
- Light source: COB LED with a lens or a high efficiency reflector of optical.

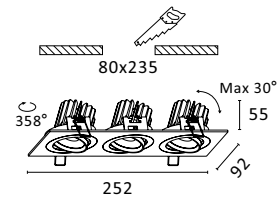

COB LED

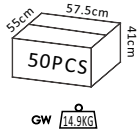

GW 14.9KG

**R6161 3x6W 2100lm**  
 With LED Driver 36V-135mA  
 230V-50Hz

NW  
 1.33kg

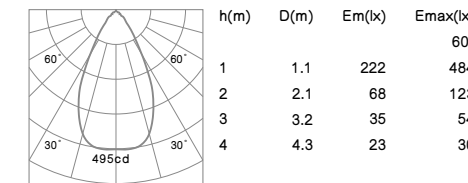
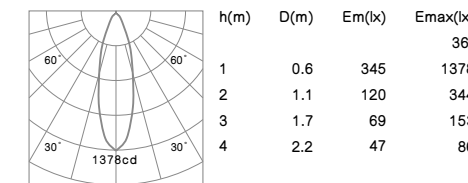
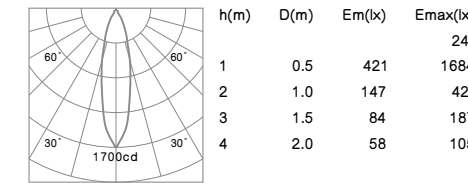

**R6161 3x10W 3600lm**  
 With LED Driver 36V-250mA  
 230V-50Hz

NW  
 1.33kg

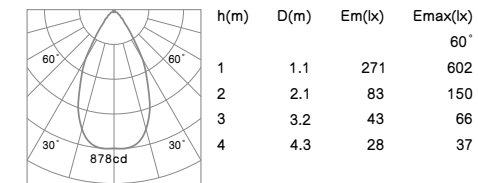
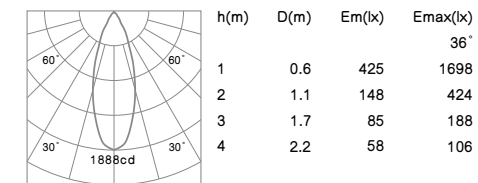
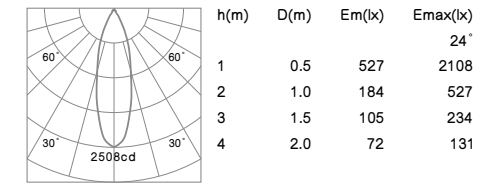



# ROSU



**COB LED CRI≥80 IP44 CE RoHS**  
 Mounting frame color: White Silver Black  
 Color temperature: 2700K 3000K 4000K  
 Beam angle: 24° 36° 60°

Driver gear for LED:  
 Non-Dimmable  
 1-10V Dimmable  
 DALI Dimmable  
 Triac Dimmable

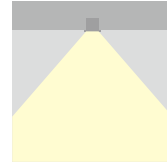

- Housing: Cast aluminum.
- Light source: COB LED with a lens of optical.

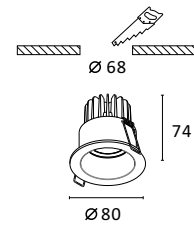

**R6116 6W 707lm**  
 With LED Driver 36V-135mA  
 230V-50Hz

NW  
 0.25kg

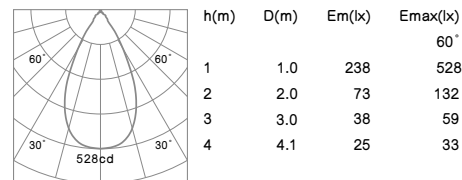
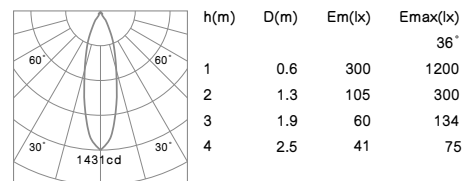
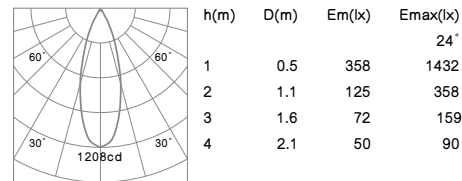

**R6116 10W 1227lm**  
 With LED Driver 36V-250mA  
 230V-50Hz

NW  
 0.25kg

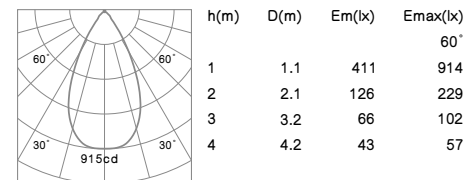
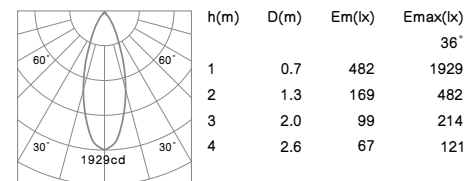
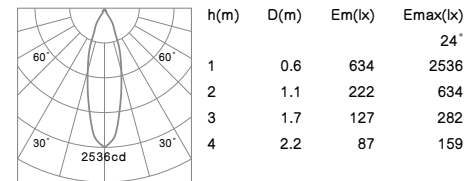

# ROSU



**COB LED CRI≥80 IP44 CE RoHS**  
 Mounting frame color: White Silver Black  
 Color temperature: 2700K 3000K 4000K  
 Beam angle: 24° 36° 60°

Driver gear for LED:  
 Non-Dimmable  
 1-10V Dimmable  
 DALI Dimmable  
 Triac Dimmable

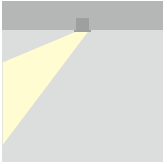

- Housing: Cast aluminum.
- The down light tilts to a maximum of 0°-30° onto the vertical plane.
- Light source: COB LED with a lens of optical.

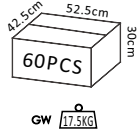
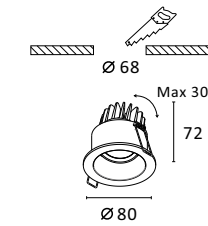

**R6117 6W 682lm**  
 With LED Driver 36V-135mA  
 230V-50Hz

NW  
 0.25kg

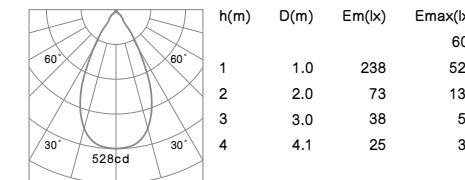
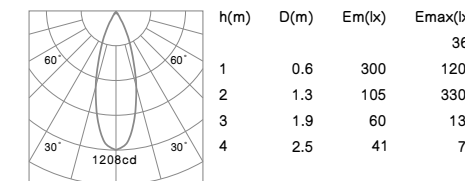
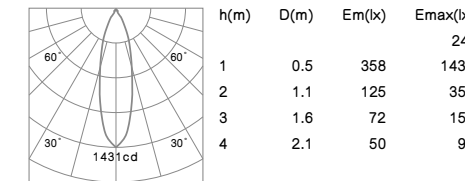

**R6117 10W 1198lm**  
 With LED Driver 36V-250mA  
 230V-50Hz

NW  
 0.25kg

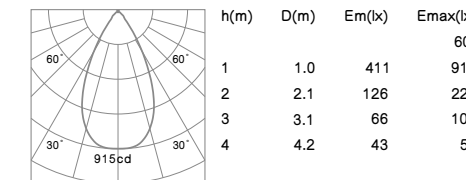
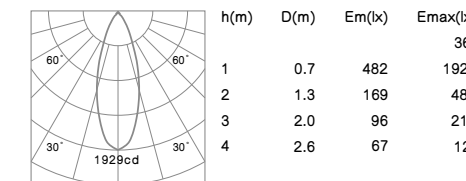
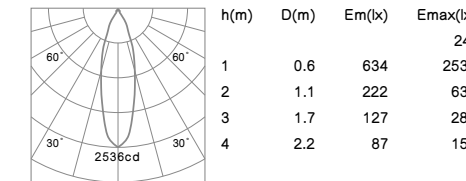

# ROSU



**COB LED CRI≥80 IP44 CE RoHS**  
 Mounting frame color: White Silver Black  
 Color temperature: 2700K 3000K 4000K  
 Beam angle: 24° 36° 60°

Driver gear for LED:  
 Non-Dimmable  
 1-10V Dimmable  
 DALI Dimmable  
 Triac Dimmable

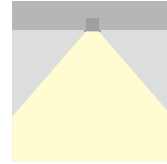

- Housing: Cast aluminum.
- Light source: COB LED with a lens of optical.

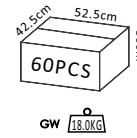
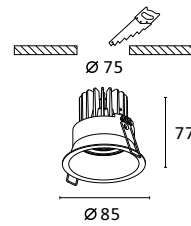

**R6867 6W 682lm**  
 With LED Driver 36V-135mA  
 230V-50Hz

NW  
 0.24kg

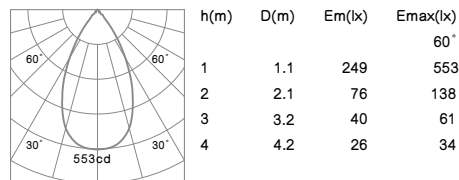
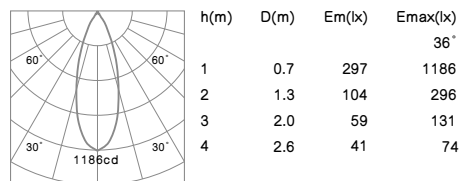
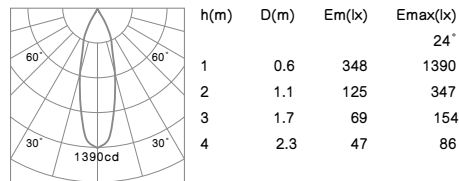

**R6867 10W 1198lm**  
 With LED Driver 36V-250mA  
 230V-50Hz

NW  
 0.24kg

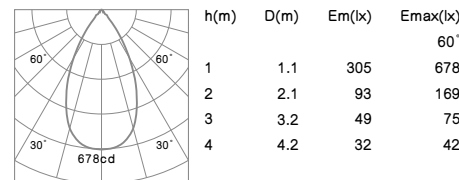
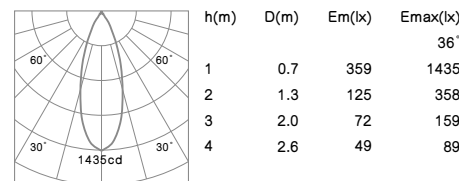
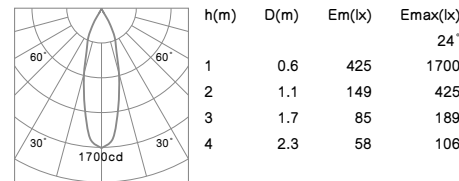

# ROSU



**COB LED CRI≥80 IP44 CE RoHS**  
 Mounting frame color: White Silver Black  
 Color temperature: 2700K 3000K 4000K  
 Beam angle: 24° 36° 60°

Driver gear for LED:  
 Non-Dimmable  
 1-10V Dimmable  
 DALI Dimmable  
 Triac Dimmable

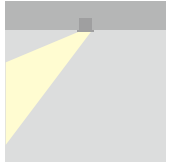

- Housing: Cast aluminum.
- The down light tilts to a maximum of 0°-30° onto the vertical plane.
- Light source: COB LED with a lens of optical.

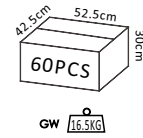
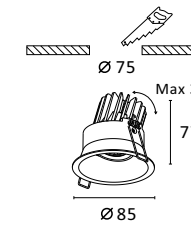

**R6866 6W 682lm**  
 With LED Driver 36V-135mA  
 230V-50Hz

NW  
 0.25kg

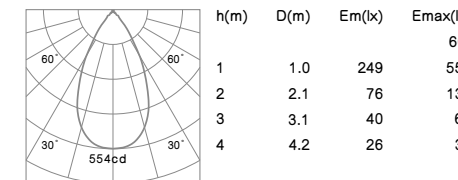
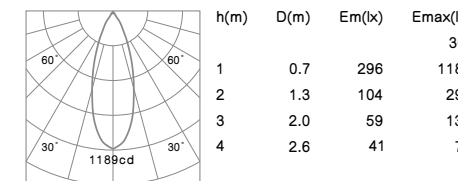
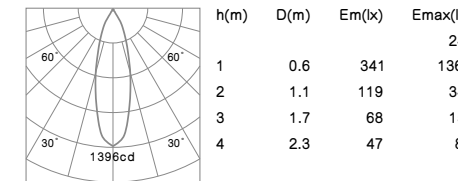

**R6866 10W 1198lm**  
 With LED Driver 36V-250mA  
 230V-50Hz

NW  
 0.25kg

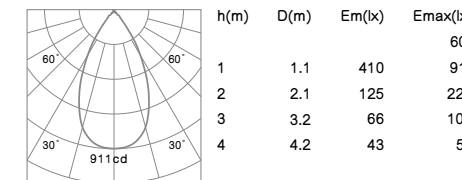
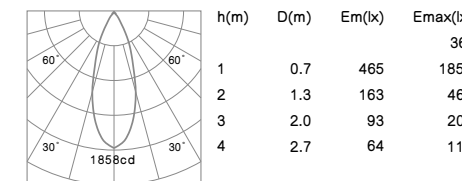
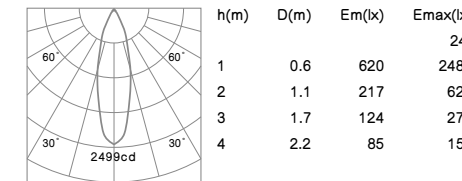

# ROSU



**COB LED CRI≥80 IP44 CE RoHS**  
 Mounting frame color: White Silver Black  
 Color temperature: 2700K 3000K 4000K  
 Beam angle: 24° 36° 60°

Driver gear for LED:  
 Non-Dimmable  
 1-10V Dimmable  
 DALI Dimmable  
 Triac Dimmable

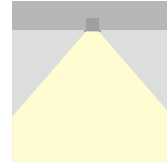

- Housing: Cast aluminum.
- Light source: COB LED with a lens of optical.

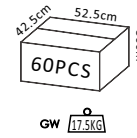
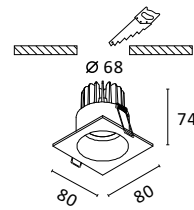

**R6324 6W 707lm**  
 With LED Driver 36V-135mA  
 230V-50Hz

NW  
0.26kg

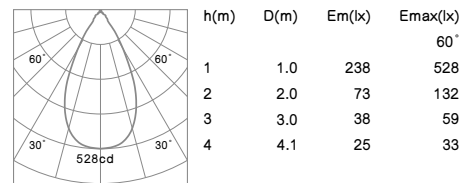
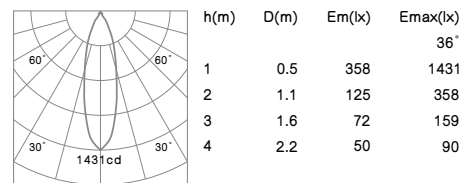
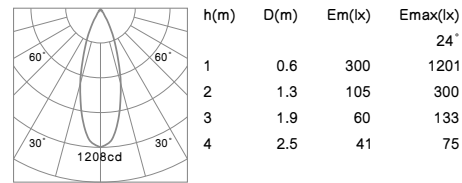

**R6324 10W 1227lm**  
 With LED Driver 36V-250mA  
 230V-50Hz

NW  
0.26kg

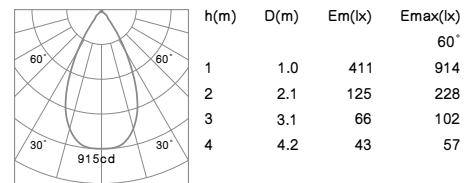
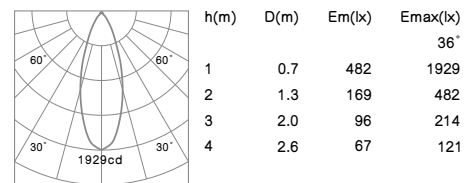
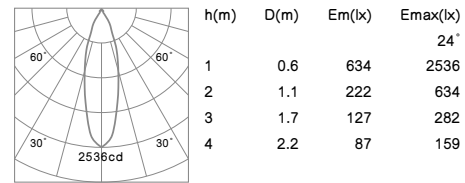

# ROSU



**COB LED CRI≥80 IP44 CE RoHS**  
 Mounting frame color: White Silver Black  
 Color temperature: 2700K 3000K 4000K  
 Beam angle: 24° 36° 60°

Driver gear for LED:  
 Non-Dimmable  
 1-10V Dimmable  
 DALI Dimmable  
 Triac Dimmable

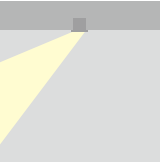

- Housing: Cast aluminum.
- The down light tilts to a maximum of 0°-30° onto the vertical plane.
- Light source: COB LED with a lens of optical.

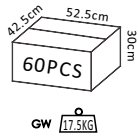
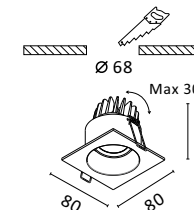

**R6118 6W 682lm**  
 With LED Driver 36V-135mA  
 230V-50Hz

NW  
0.26kg

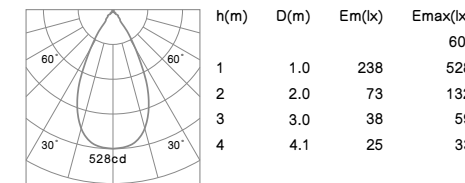
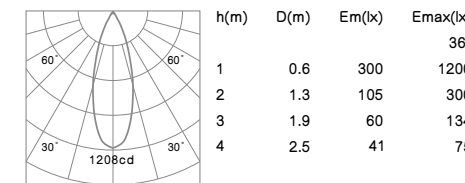
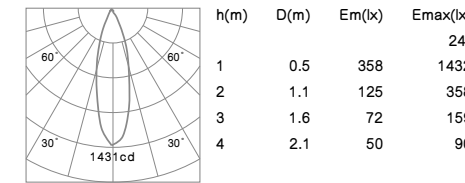

**R6118 10W 1198lm**  
 With LED Driver 36V-250mA  
 230V-50Hz

NW  
0.26kg

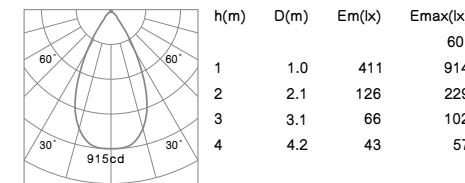
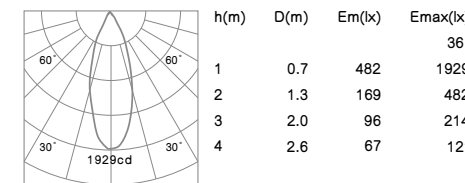
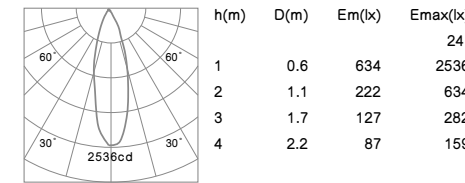



STAR

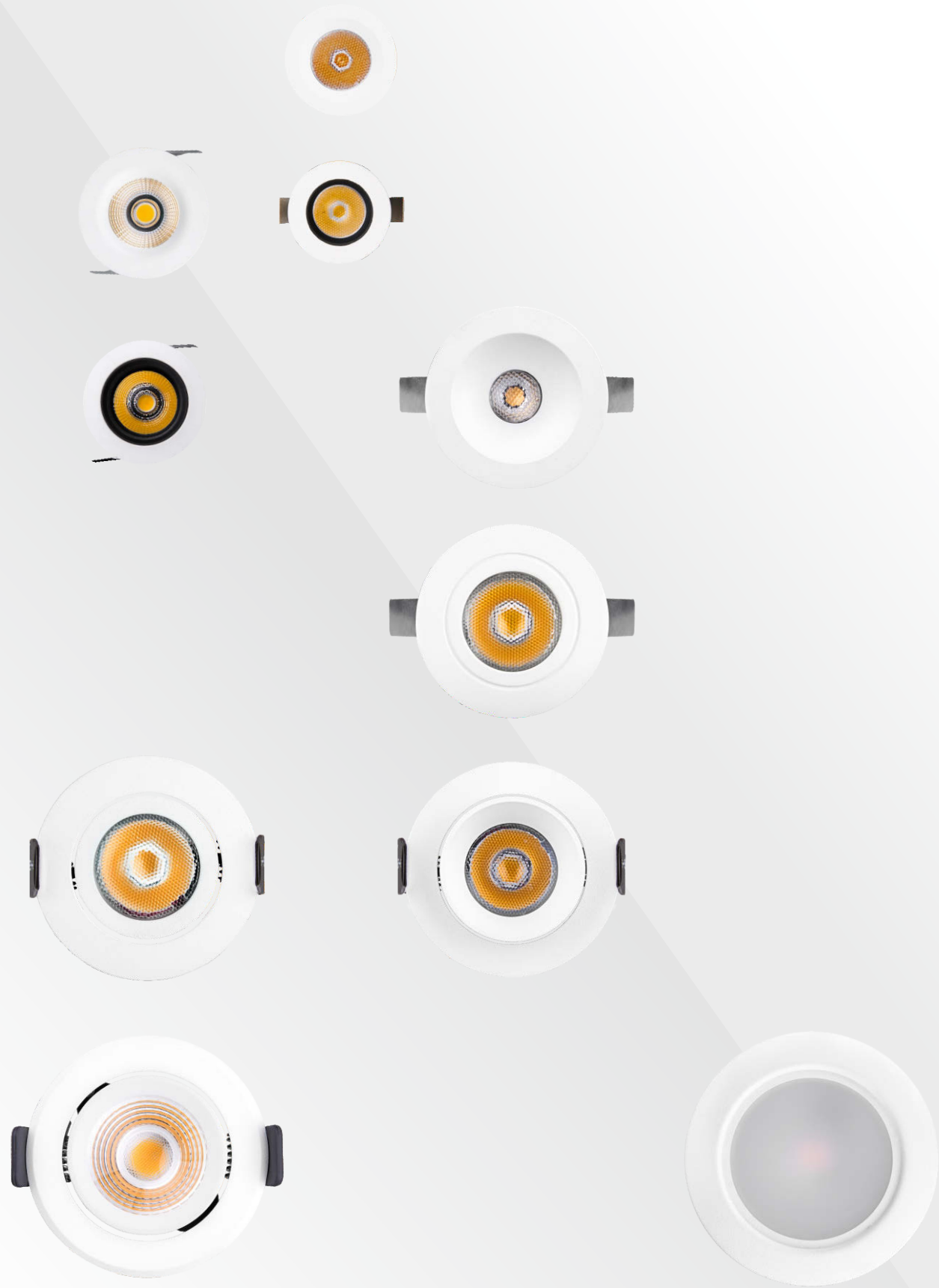

217

STAR

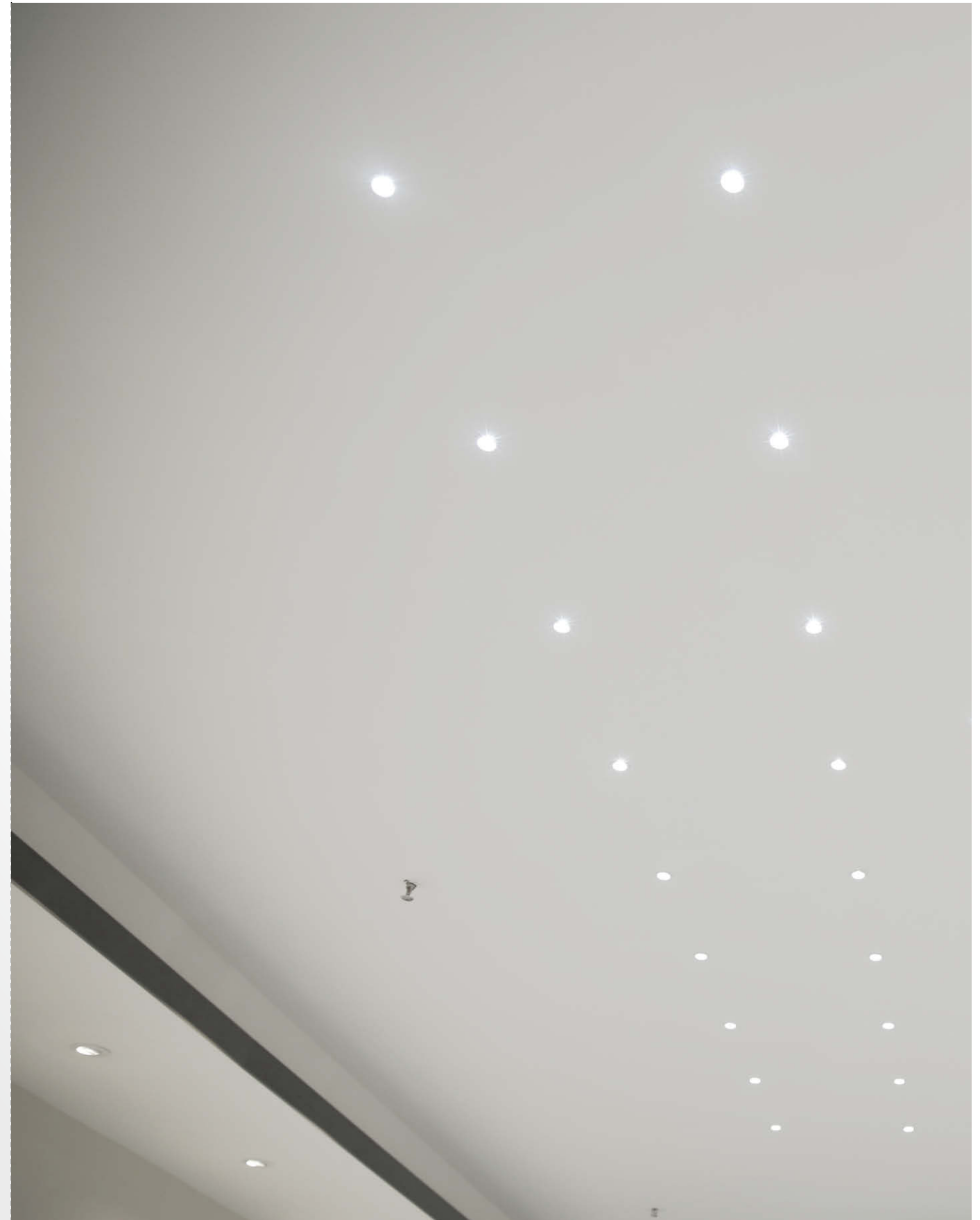

218

STAR



STAR

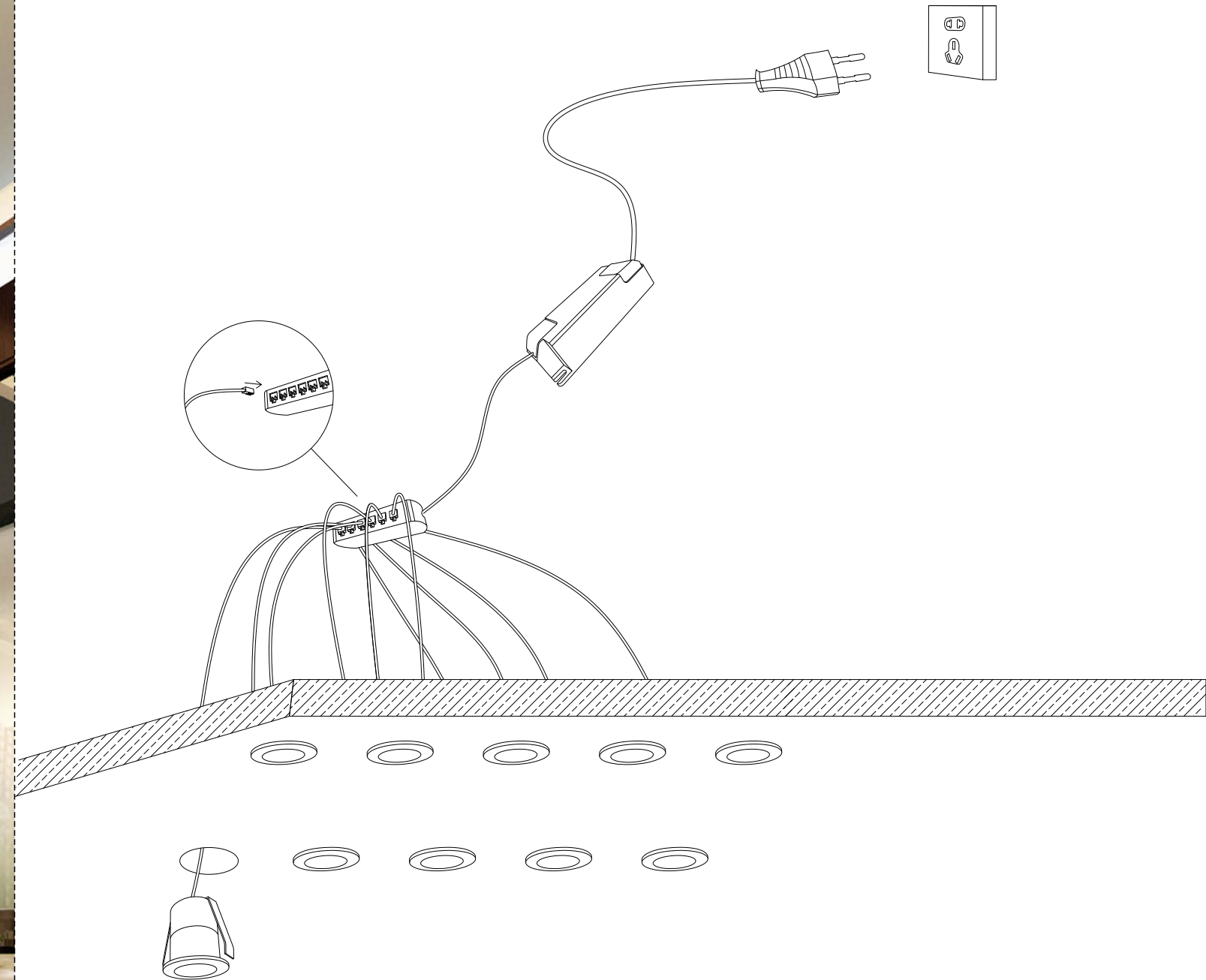

Multiple

One driver connects 9-12PCS lamps  
( R6830 / R6831 )

# STAR

	Ø 32mm	1W	P222
	Ø 32mm	1W 3W	P223
	Ø 48mm	3W	P225
	Ø 48mm	3W	P226
	Ø 58mm	3W	P227
	Ø 58mm	3W	P228
	Ø 65mm	6W	P229
	Ø 65mm	6W	P230
	Ø 65mm	6W	P231
	Ø 80mm	6W	P232
	Ø 50mm	3W	P233
	Ø 70mm	3W	P234

# STAR



•Housing and mounting ring: Pure aluminum.  
•Light source: SMD LED with a lens of optical.

R6830 1W 100lm  
With LED Driver 3V-250mA  
230V-50Hz

NW  
0.03kg

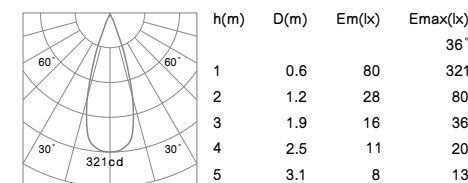
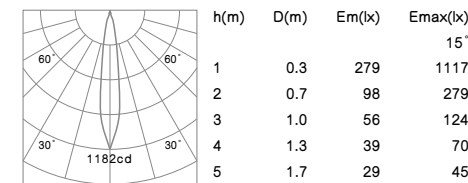

**SMD LED CRI≥80 IP44 CE RoHS**  
Mounting frame color: White Silver Black  
Color temperature: 2700K 3000K 4000K  
Beam angle: 15° 24° 36° 60°

Driver gear for LED:  
Non-Dimmable  
1-10V Dimmable  
DALI Dimmable  
Triac Dimmable

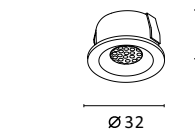
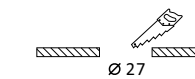

SMD LED

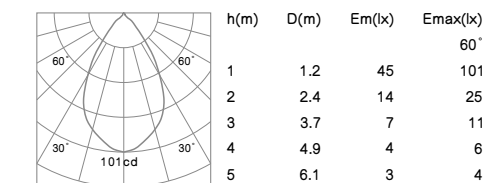
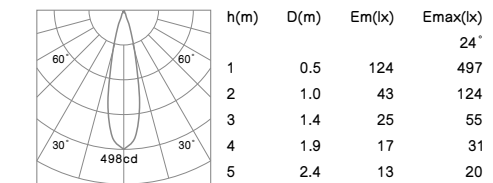
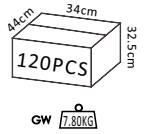
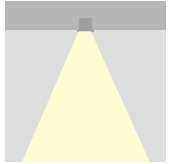

# STAR



**SMD LED CRI≥80 IP44 CE RoHS**

Mounting frame color: White Silver Black  
 Color temperature: 2700K 3000K 4000K  
 Beam angle: 15° 24° 36° 60°

Driver gear for LED:  
 Non-Dimmable  
 1-10V Dimmable  
 DALI Dimmable  
 Triac Dimmable

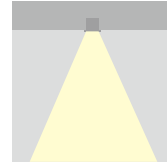

- Housing and mounting ring: Pure aluminum.
- Light source: SMD LED with a lens of optical.
- UGR<19.

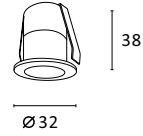
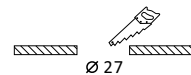

SMD LED

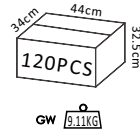

GW 5.11KG

**R6831 1W 90lm**  
 With LED Driver 3V-250mA  
 230V-50Hz

NW  
 0.04kg

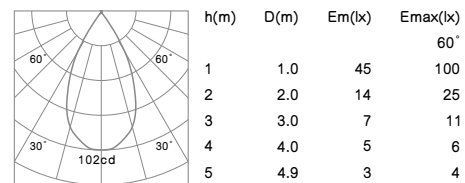
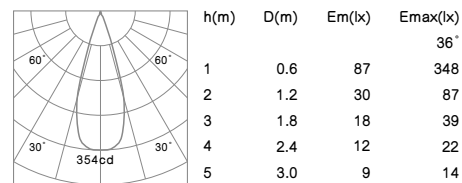
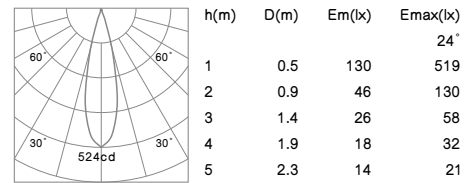
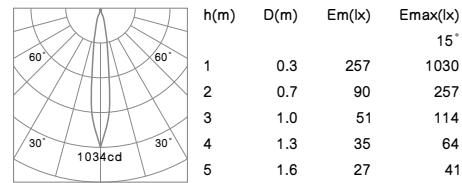

# STAR

**R6831 3W 180lm**  
 With LED Driver 3V-350mA  
 230V-50Hz

NW  
 0.04kg

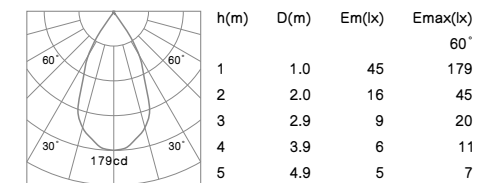
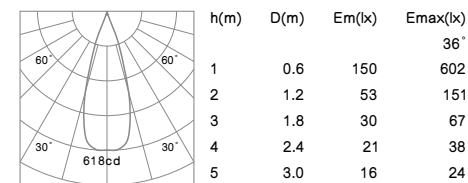
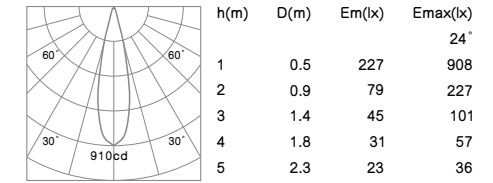
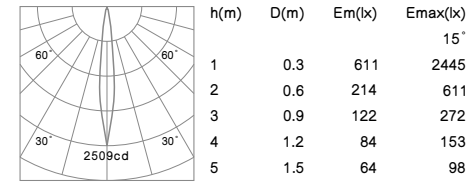



# STAR



**COB LED CRI≥80 IP44 CE RoHS**

Mounting frame color: White Silver Black  
 Color temperature: 2700K 3000K 4000K  
 Beam angle: 30°

Driver gear for LED: Non-Dimmable

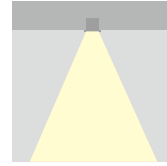

•Housing and mounting ring: Pure aluminum.  
 •Light source: COB LED with a lens of optical.

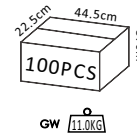
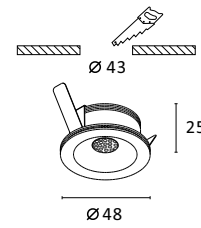

**R6013 3W 170lm**  
 With LED Driver 9V-350mA  
 230V-50Hz

NW  
 0.09kg

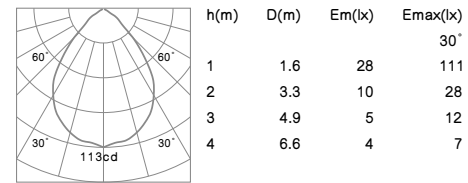

# STAR



**COB LED CRI≥80 IP44 CE RoHS**

Mounting frame color: White Silver Black  
 Color temperature: 2700K 3000K 4000K  
 Beam angle: 25° 40°

Driver gear for LED: Non-Dimmable

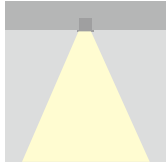

•Housing and mounting ring: Pure aluminum.  
 •Light source: COB LED with a lens of optical.

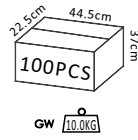
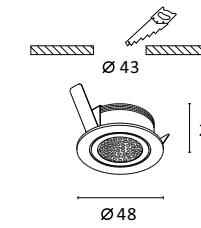

**R6011 3W 230lm**  
 With LED Driver 9V-350mA  
 230V-50Hz

NW  
 0.08kg

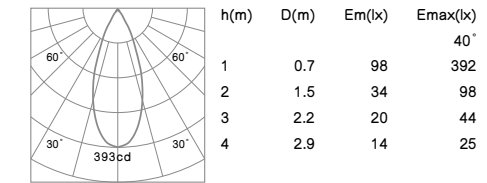
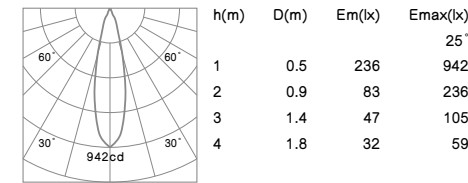

# STAR



**COB LED CRI≥80 IP44 CE RoHS**  
 Mounting frame color: White Silver Black  
 Color temperature: 2700K 3000K 4000K  
 Beam angle: 25° 40°

Driver gear for LED: Non-Dimmable

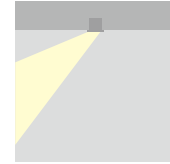

- Housing and mounting ring: Pure aluminum.
- The down light tilts to a maximum of 0°-30° onto the vertical plane and rotates by 358° onto the horizontal plane.
- Light source: COB LED with a lens of optical.

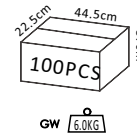
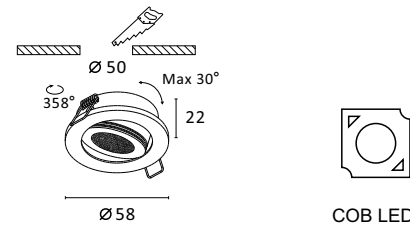

**R6017 3W 230lm**  
 With LED Driver 9V-350mA  
 230V-50Hz

NW  
 0.10kg

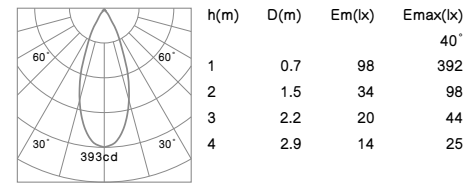
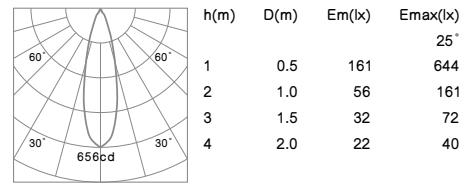

# STAR



**COB LED CRI≥80 IP44 CE RoHS**  
 Mounting frame color: White Silver Black  
 Color temperature: 2700K 3000K 4000K  
 Beam angle: 25° 40°

Driver gear for LED: Non-Dimmable

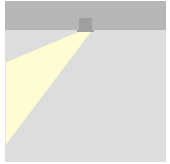

- Housing and mounting ring: Pure aluminum.
- The down light tilts to a maximum of 0°-30° onto the vertical plane and rotates by 358° onto the horizontal plane.
- Light source: COB LED with a lens of optical.

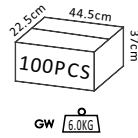
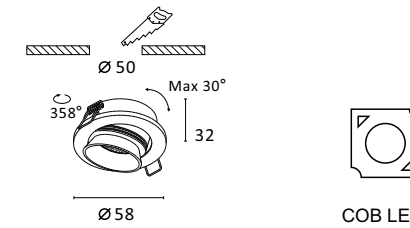

**R6015 3W 230lm**  
 With LED Driver 9V-350mA  
 230V-50Hz

NW  
 0.10kg

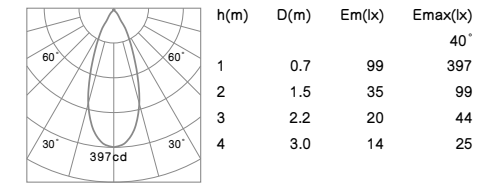
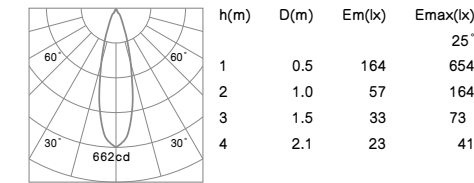

# STAR Clear



<b>COB LED</b>	<b>CRI≥80</b>	<b>IP44</b>	<b>CE</b>	<b>RoHS</b>
Mounting frame color:	White	Silver	Black	
Color temperature:	2700K	3000K	4000K	
Beam angle:	20°	40°		

Driver gear for LED:

- Non-Dimmable
- 1-10V Dimmable
- DALI Dimmable
- Triac Dimmable

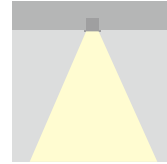

- Mounting ring: Pure aluminum.
- Heat sink: Cast aluminum.
- Light source: COB LED with a high efficiency reflector of optical and clear glass.
- Anti-dazzling ring: Aluminum black.
- UGR<19.

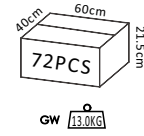
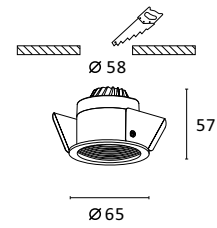

**R6842 6W 420lm**  
With LED Driver 36V-135mA  
230V-50Hz

NW  
0.12kg

	h(m)	D(m)	Em(lx)	E <sub>max</sub> (lx)
	1	0.4	528	2113
	2	0.8	185	528
	3	1.2	106	235
	4	1.6	73	132
	5	2.0	55	85

	h(m)	D(m)	Em(lx)	E <sub>max</sub> (lx)
	1	0.7	223	891
	2	1.4	78	223
	3	2.1	45	99
	4	2.9	31	56
	5	3.6	23	36

# STAR Diffuse



<b>COB LED</b>	<b>CRI≥80</b>	<b>IP44</b>	<b>CE</b>	<b>RoHS</b>
Mounting frame color:	White	Silver	Black	
Color temperature:	2700K	3000K	4000K	
Beam angle:	50°			

Driver gear for LED:

- Non-Dimmable
- 1-10V Dimmable
- DALI Dimmable
- Triac Dimmable

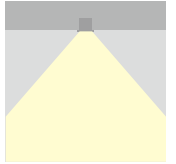

- Mounting ring: Pure aluminum.
- Heat sink: Cast aluminum.
- Light source: COB LED with a high efficiency reflector of optical and a diffuse sheet.
- Anti-dazzling ring: Aluminum black.
- UGR<19.

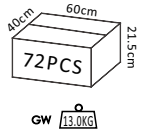
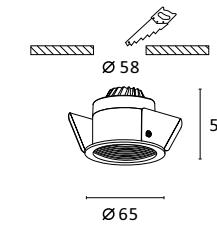

**R6843 6W 240lm**  
With LED Driver 36V-135mA  
230V-50Hz

NW  
0.12kg

	h(m)	D(m)	Em(lx)	E <sub>max</sub> (lx)
	1	0.9	70	278
	2	1.9	25	70
	3	2.8	14	31
	4	3.7	9	17
	5	4.7	7	11

# STAR



**COB LED CRI≥80 IP44 CE RoHS**  
 Mounting frame color: White Silver Black  
 Color temperature: 2700K 3000K 4000K  
 Beam angle: 20° 40°

Driver gear for LED:  
 Non-Dimmable  
 1-10V Dimmable  
 DALI Dimmable  
 Triac Dimmable

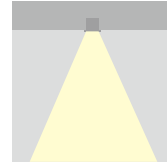

- Luminaire housing: Cast aluminum.
- Light source: COB LED with a high efficiency reflector of optical.
- Mounting ring: Pure aluminum.

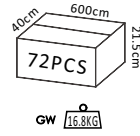
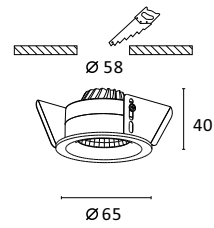

**R6103 6W 610lm**  
 With LED Driver 36V-135mA  
 230V-50Hz

NW  
 0.12kg

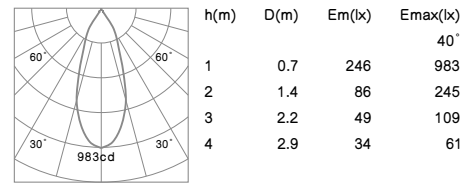
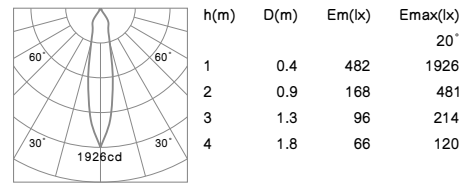

# STAR



**COB LED CRI≥80 IP44 CE RoHS**  
 Mounting frame color: White Silver Black  
 Color temperature: 2700K 3000K 4000K  
 Beam angle: 24° 36° 60°

Driver gear for LED:  
 Non-Dimmable  
 1-10V Dimmable  
 DALI Dimmable  
 Triac Dimmable

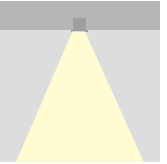

- Housing and mounting frame: Cast aluminum.
- The spot light tilts to a maximum of 0°-30° onto the vertical plane and rotates by 358° onto the horizontal plane.
- Light source: COB LED with a lens of optical.

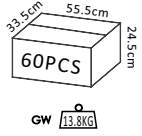
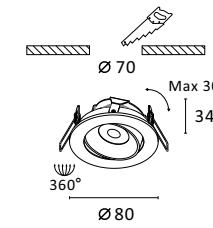

**R6018 6W 650lm**  
 With LED Driver 36V-135mA  
 230V-50Hz

NW  
 0.14kg

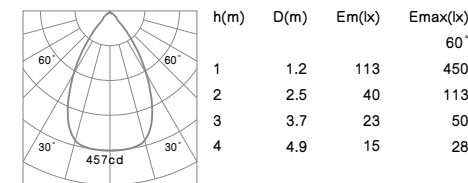
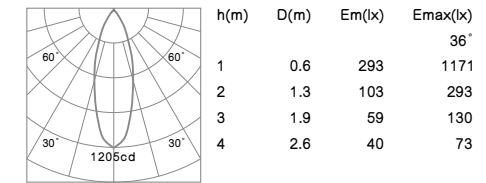
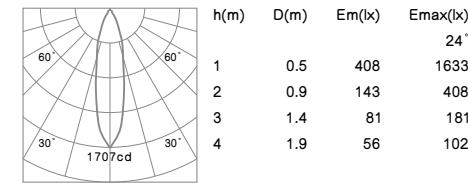



# STAR



**COB LED CRI≥80 IP20 CE RoHS**

Housing color: White Silver Black  
 Color temperature: 2700K 3000K 4000K  
 Beam angle: 24° 36° 60°

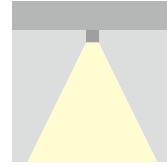

- Luminaire housing: Pure aluminum.
- Light source: COB LED with a lens of optical.

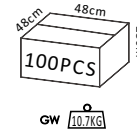
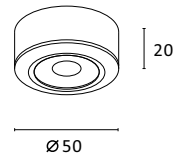

**C6019 3W 288lm**  
 With LED Driver 9V-350mA  
 230V-50Hz

NW  
 0.09kg

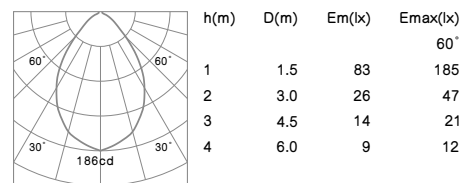
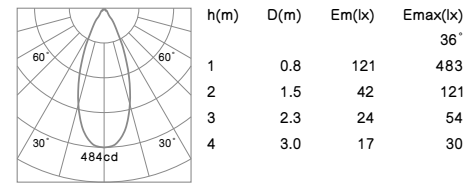
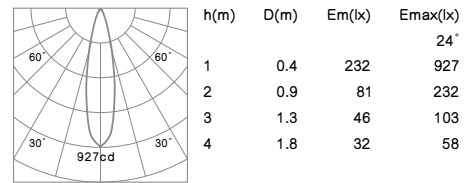

# STAR



**COB LED CRI≥80 IP20 CE RoHS**

Housing color: White Silver Black  
 Color temperature: 2700K 3000K 4000K  
 Beam angle: 95°

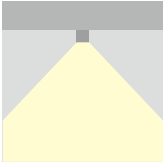

- Luminaire housing: Pure aluminum.
- Light source: COB LED with a diffuser of optical.

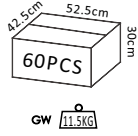
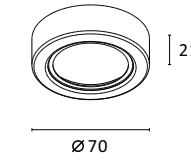

**C6023 3W 205lm**  
 With LED Driver 9V-350mA  
 230V-50Hz

NW  
 0.13kg

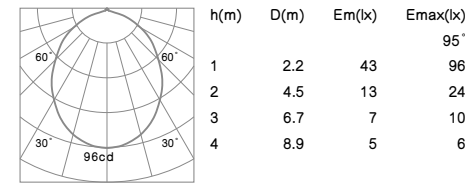

PANA



235

PANA



236

PANA



237

PANA



Ø 240mm SMD15W

P239



Ø 240mm SMD15W+COB20W

P240

238

# PANA



<b>SMD LED</b>	<b>CRI≥80</b>	<b>IP20</b>	<b>CE</b>	<b>RoHS</b>
Mounting frame color:	White	Silver	Black	
Color temperature:	2700K	3000K	4000K	

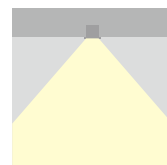

- Housing: Aluminum sheet.
- Circle ring light source: High power LED with a diffuse of optical.
- The light can be compatible with emergency battery.

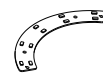
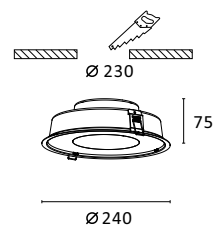

SMD LED

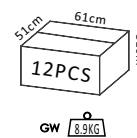

**R6245 15W 900lm**  
With LED Driver 36V-350mA  
230V-50Hz

NW  
0.45kg

	h(m)	D(m)	Em(lx)	E <sub>max</sub> (lx)
				100°
	1	2.3	151	336
	2	4.6	46	84
	3	6.9	24	37
	4	9.1	16	21
	5	11.4	11	13

# PANA



<b>SMD+COB LED</b>	<b>CRI≥80</b>	<b>IP20</b>	<b>CE</b>	<b>RoHS</b>
Mounting frame color:	White	Silver	Black	
Color temperature:	2700K	3000K	4000K	

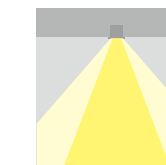

Driver gear for LED:  
Non-Dimmable  
1-10V Dimmable  
DALI Dimmable  
Triac Dimmable

- Housing: Aluminum sheet.
- Spot light module tilts to a maximum of 0°-25° onto the vertical plane and rotates by 358° onto the horizontal plane.
- Circle ring light source: SMD LED with a diffuse of optical.
- Spot light module: COB LED with a lens of optical.
- The light can be compatible with emergency battery.

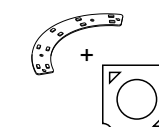
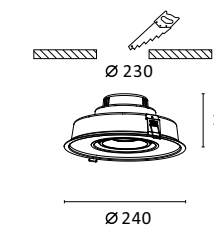

SMD + COB LED

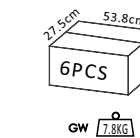

**R6280**  
Circle ring: 15W 900lm with LED driver 36V-350mA  
Spot light module: 20W 2000lm with LED driver 36V-500mA

NW  
1.20kg

	h(m)	D(m)	Em(lx)	E <sub>max</sub> (lx)
				100°
	1	2.3	151	336
	2	4.6	46	84
	3	6.9	24	37
	4	9.1	16	21
	5	11.4	11	13

	h(m)	D(m)	Em(lx)	E <sub>max</sub> (lx)
				15°
	1	0.5	1998	4441
	2	0.9	611	1110
	3	1.4	320	493
	4	1.8	209	278
	5	2.3	151	178

	h(m)	D(m)	Em(lx)	E <sub>max</sub> (lx)
				24°
	1	0.5	1833	4073
	2	1.1	560	1018
	3	1.6	294	452
	4	2.1	191	255
	5	2.7	139	163

	h(m)	D(m)	Em(lx)	E <sub>max</sub> (lx)
				36°
	1	0.7	1222	2716
	2	1.4	373	679
	3	2.1	196	302
	4	2.8	128	170
	5	3.4	93	109



RONO R

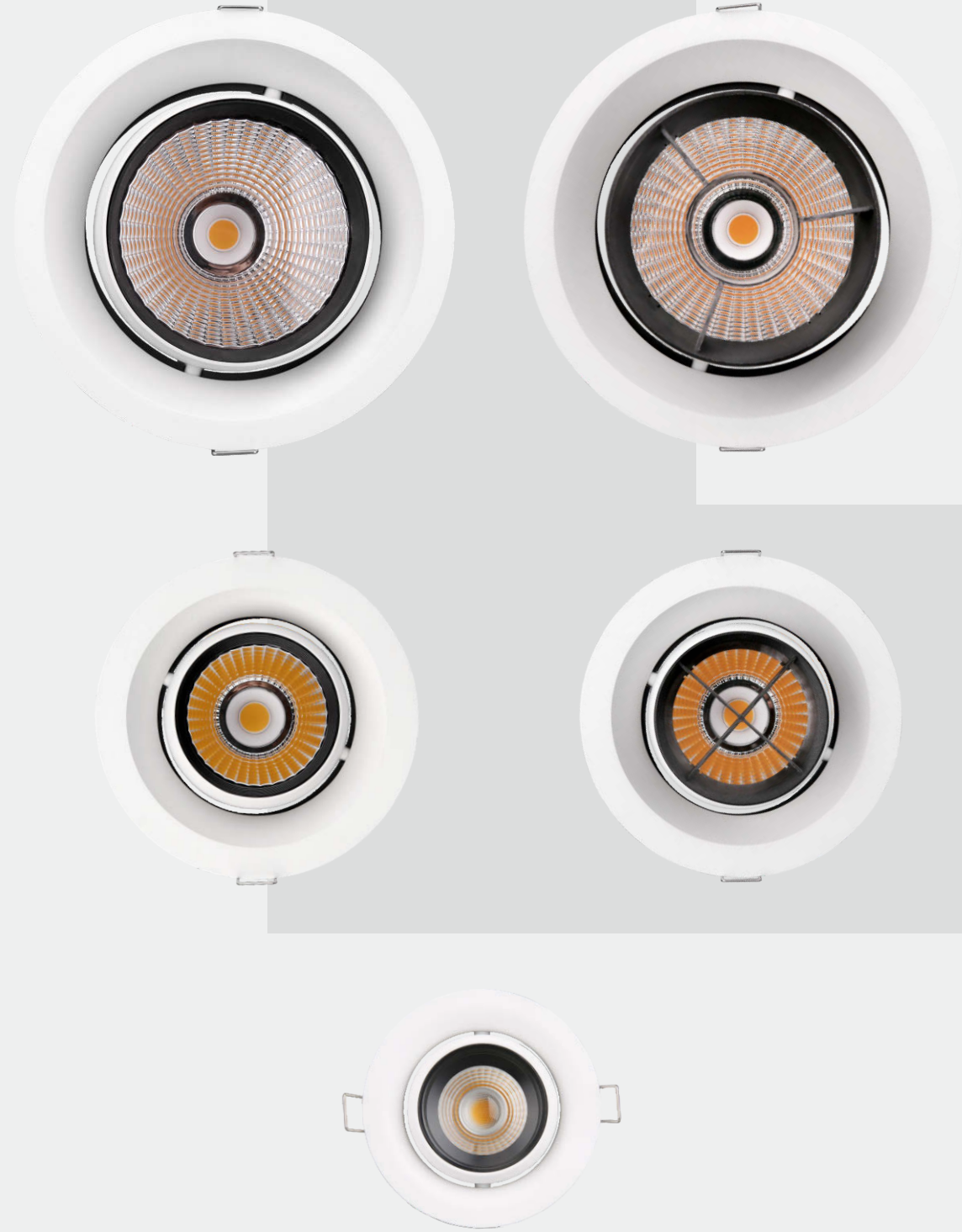

241

RONO R

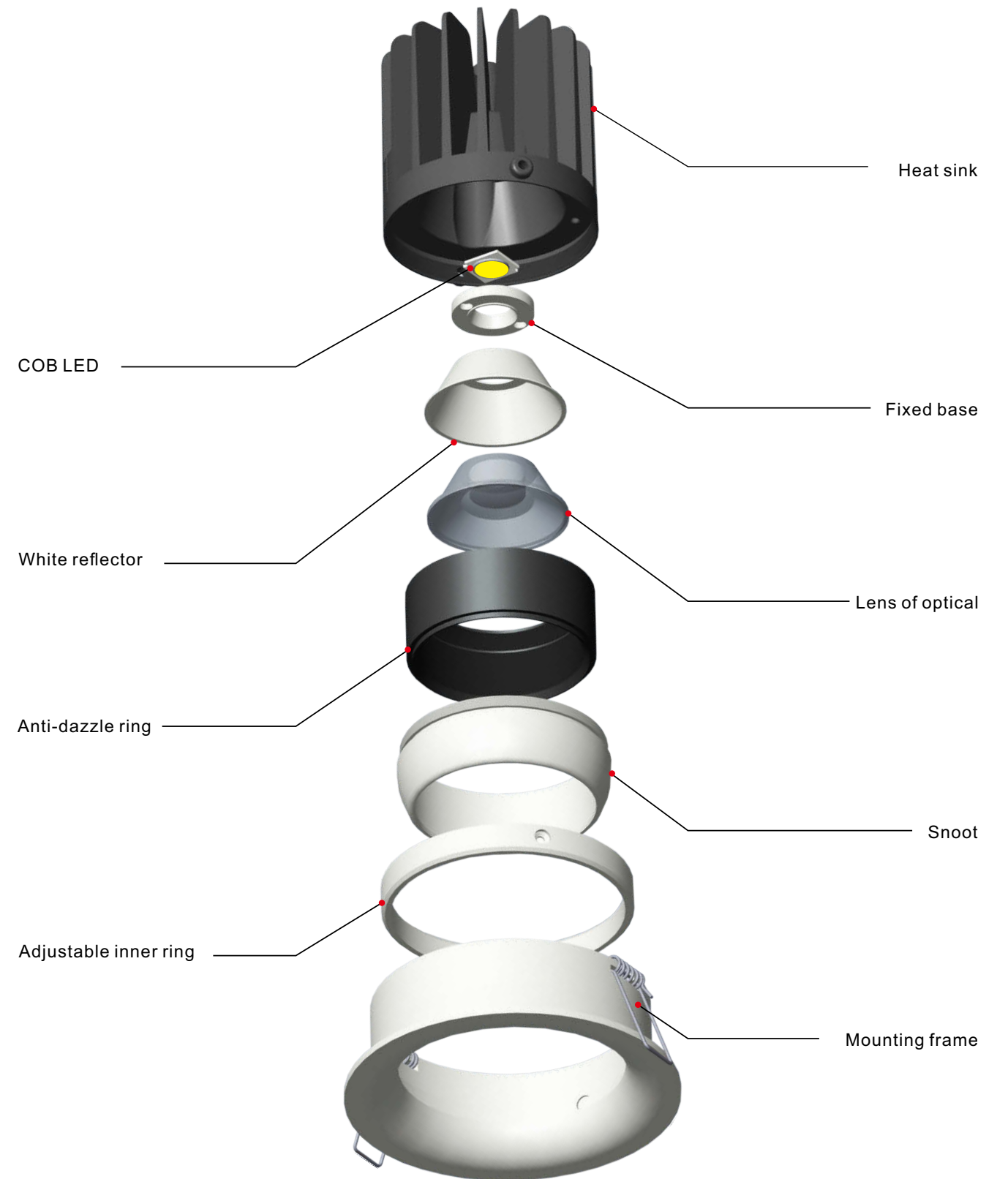

242

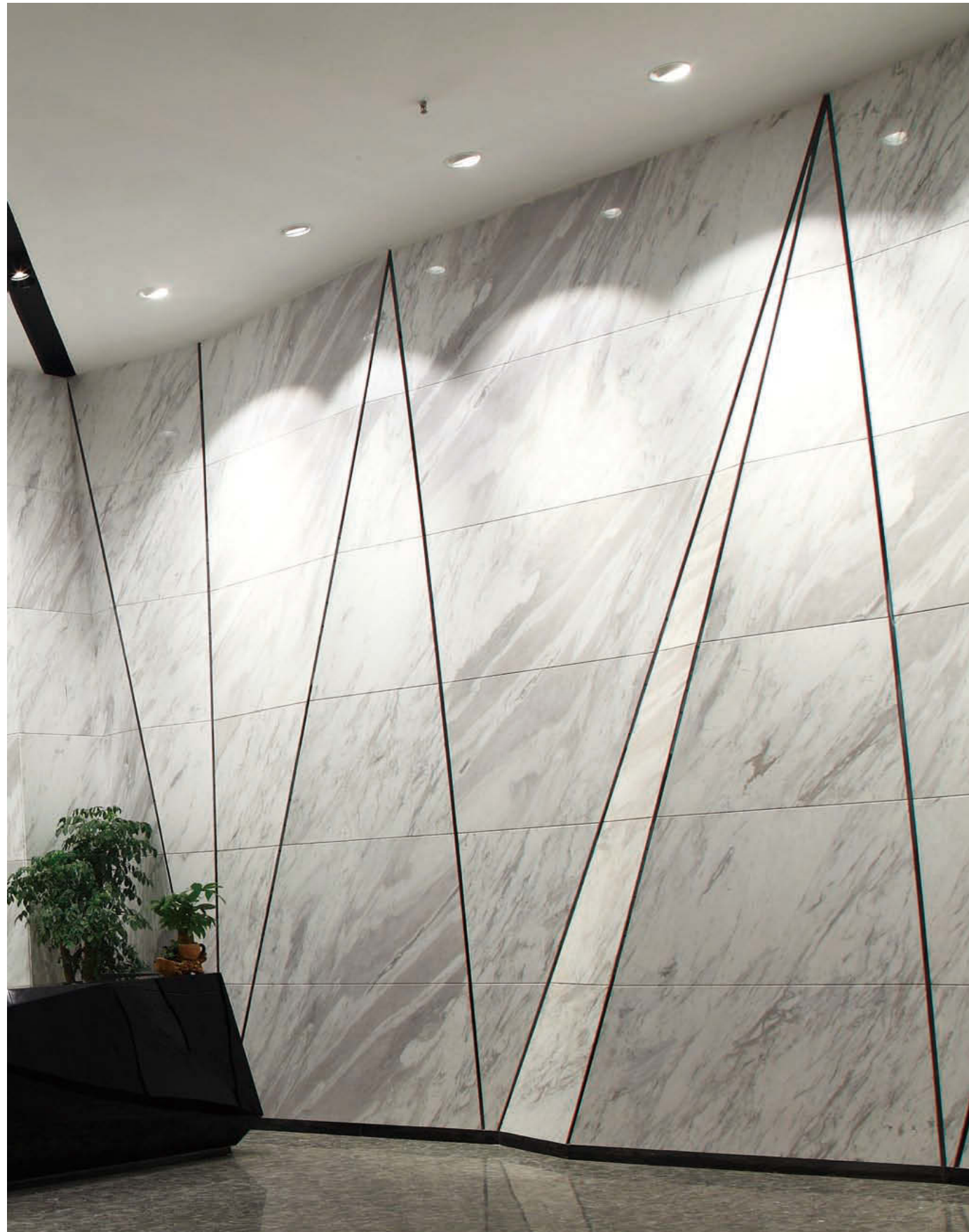

S Ø 102mm 6W 10W 15W

P245



M Ø 150mm 15W 20W 25W

P247



M Ø 150mm 15W 20W 25W

P249



L Ø 186mm 20W 25W 30W 40W

P251



L Ø 186mm 20W 25W 30W 40W

P254

# RONO R s



**COB LED CRI≥80 IP44 CE RoHS**

Mounting frame color: White Silver Black  
 Color temperature: 2700K 3000K 4000K  
 Beam angle: 24° 36° 60°

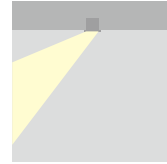

Driver gear for LED: Non-Dimmable  
 1-10V Dimmable  
 DALI Dimmable  
 Triac Dimmable

- Housing and mounting frame: Cast aluminum.
- The spot light tilts to a maximum of 0°-30° onto the vertical plane and rotates by 358° onto the horizontal plane.
- Anti-dazzle ring: Aluminum black.
- Light source: COB LED with a lens of optical.

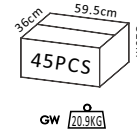
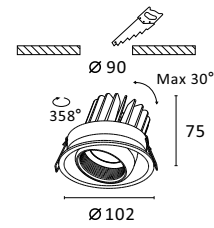

## R6924 6W 470lm With LED Driver 36V-135mA 230V-50Hz

NW  
0.42kg

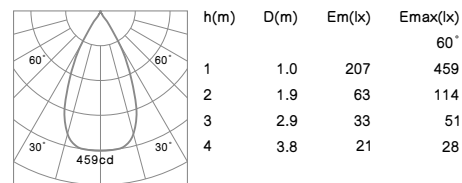
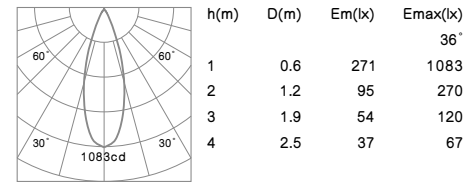
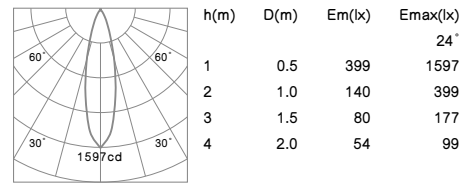

## R6924 10W 750lm With LED Driver 36V-250mA 230V-50Hz

NW  
0.42kg

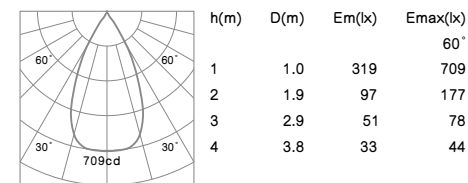
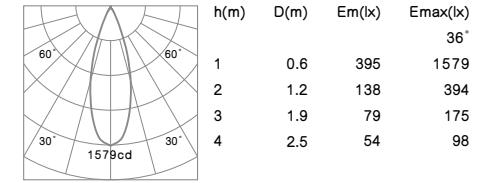
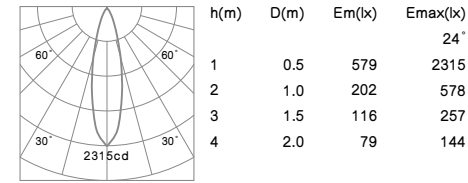

## R6924 15W 1060lm With LED Driver 36V-350mA 230V-50Hz

NW  
0.42kg

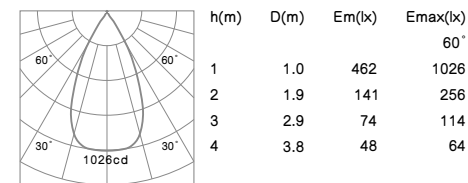
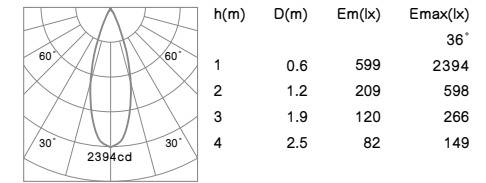
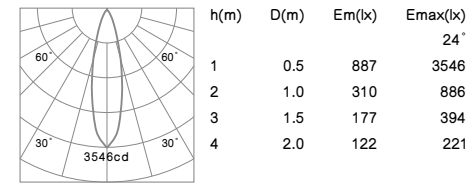



# RONO R M



**COB LED CRI≥80 IP20 CE RoHS**

Mounting frame color: White Silver Black  
 Color temperature: 2700K 3000K 4000K  
 Beam angle: 15° 24° 36° 60°

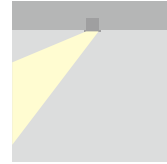

Driver gear for LED: Non-Dimmable  
 1-10V Dimmable  
 DALI Dimmable  
 Triac Dimmable

- Housing and mounting ring: Cast aluminum.
- The spot light tilts to a maximum of 0°-30° onto the vertical plane and rotates by 358° onto the horizontal plane.
- Anti-dazzle ring: Plastic black.
- Light source: COB LED with a high efficiency reflector of optical.
- The light can be compatible with emergency battery.

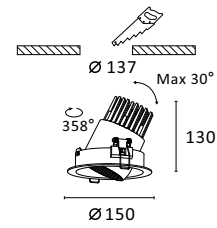

COB LED

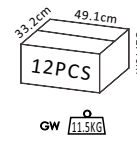

## R6083 15W 1300lm With LED Driver 36V-350mA 230V-50Hz

NW  
1.04kg

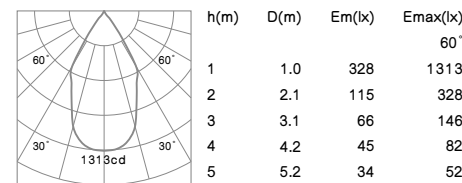
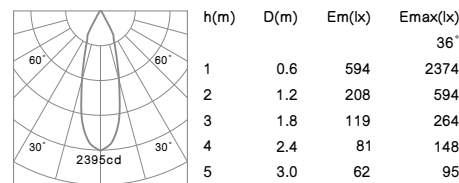
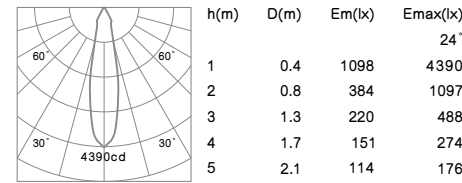
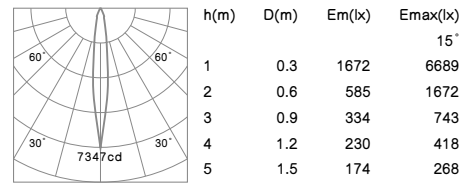

# RONO R M

## R6083 20W 1700lm With LED Driver 36V-500mA 230V-50Hz

NW  
1.04kg

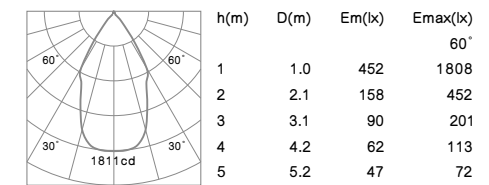
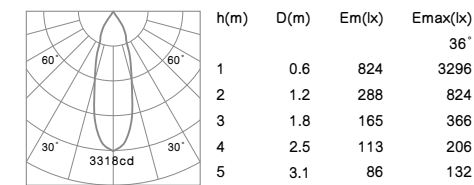
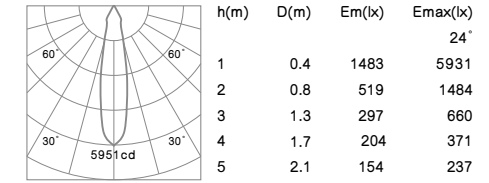
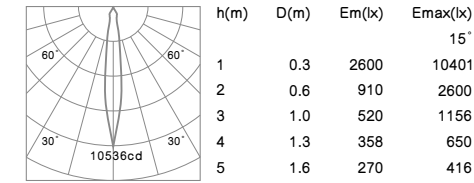

## R6083 25W 2000lm With LED Driver 36V-600mA 230V-50Hz

NW  
1.04kg

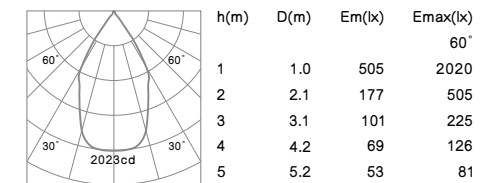
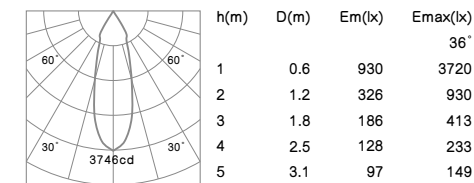
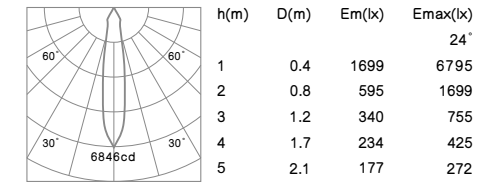
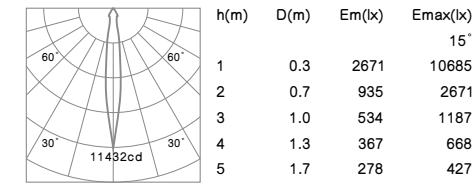



# RONO R M



**COB LED CRI≥80 IP20 CE RoHS**

Mounting frame color: White Silver Black  
 Color temperature: 2700K 3000K 4000K  
 Beam angle: 15° 24° 36°

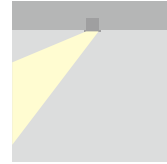

Driver gear for LED: Non-Dimmable  
 1-10V Dimmable  
 DALI Dimmable  
 Triac Dimmable

- Housing and mounting ring: Cast aluminum.
- The spot light tilts to a maximum of 0°-30° onto the vertical plane and rotates by 358° onto the horizontal plane.
- Anti-dazzle ring: Plastic black.
- Light source: COB LED with a high efficiency reflector of optical.
- The light can be compatible with emergency battery.

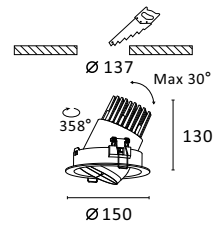

COB LED

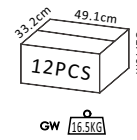

## R6084 15W 900lm With LED Driver 36V-350mA 230V-50Hz

NW  
1.07kg

h(m)	D(m)	Em(lx)	Emax(lx)
1	0.3	1690	6758
2	0.6	591	1689
3	0.9	338	751
4	1.2	232	422
5	1.5	176	270

h(m)	D(m)	Em(lx)	Emax(lx)
1	0.4	960	3838
2	0.7	336	960
3	1.1	192	427
4	1.5	132	240
5	1.8	100	154

h(m)	D(m)	Em(lx)	Emax(lx)
1	0.5	535	2138
2	1.1	187	535
3	1.6	107	238
4	2.2	74	134
5	2.7	56	86

h(m)	D(m)	Em(lx)	Emax(lx)
1	0.4	960	3838
2	0.7	336	960
3	1.1	192	427
4	1.5	132	240
5	1.8	100	154

# RONO R M

## R6084 20W 1200lm With LED Driver 36V-500mA 230V-50Hz

NW  
1.07kg

h(m)	D(m)	Em(lx)	Emax(lx)
1	0.3	2365	9460
2	0.6	828	2365
3	1.0	473	1051
4	1.3	325	591
5	1.6	246	378

h(m)	D(m)	Em(lx)	Emax(lx)
1	0.4	1299	5194
2	0.8	455	1299
3	1.2	260	577
4	1.6	179	325
5	2.0	135	208

h(m)	D(m)	Em(lx)	Emax(lx)
1	0.6	722	2886
2	1.1	253	722
3	1.7	144	321
4	2.2	99	180
5	2.8	75	115

## R6084 25W 1400lm With LED Driver 36V-600mA 230V-50Hz

NW  
1.07kg

h(m)	D(m)	Em(lx)	Emax(lx)
1	0.3	2660	10640
2	0.6	931	2660
3	1.0	532	1182
4	1.3	366	665
5	1.6	277	426

h(m)	D(m)	Em(lx)	Emax(lx)
1	0.4	1465	5861
2	0.8	513	1465
3	1.2	293	651
4	1.6	201	366
5	2.0	152	234

h(m)	D(m)	Em(lx)	Emax(lx)
1	0.5	829	3317
2	1.0	290	829
3	1.6	166	369
4	2.2	114	207
5	2.7	86	133

# RONO R L



**COB LED CRI≥80 IP20 CE RoHS**

Mounting frame color: White Silver Black  
 Color temperature: 2700K 3000K 4000K  
 Beam angle: 15° 24° 36° 60°

Driver gear for LED: Non-Dimmable  
 1-10V Dimmable  
 DALI Dimmable  
 Triac Dimmable

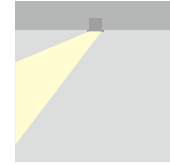

- Housing and mounting ring: Cast aluminum.
- The spot light tilts to a maximum of 0°-30° onto the vertical plane and rotates by 358° onto the horizontal plane.
- Anti-dazzle ring: Plastic black.
- Light source: COB LED with a high efficiency reflector of optical.
- The light can be compatible with emergency battery.

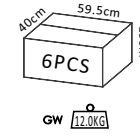
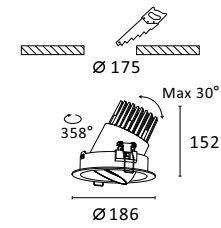

## R6291 20W 1800lm With LED Driver 36V-500mA 230V-50Hz

NW  
1.66kg

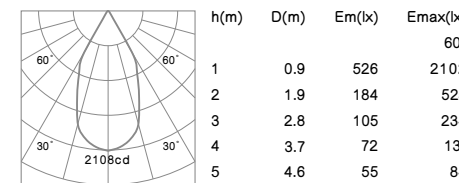
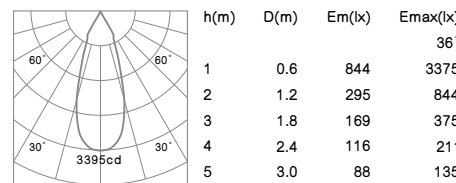
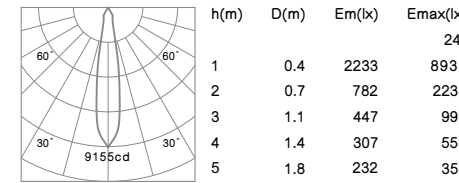
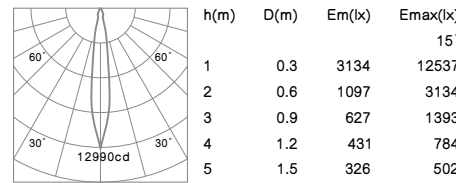

# RONO R L

## R6291 25W 2100lm With LED Driver 36V-600mA 230V-50Hz

NW  
1.66kg

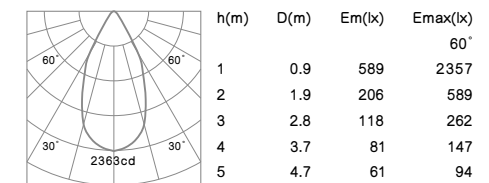
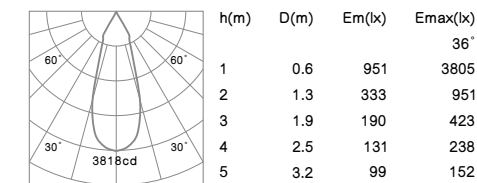
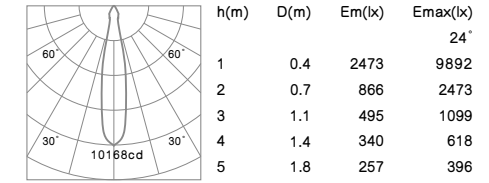
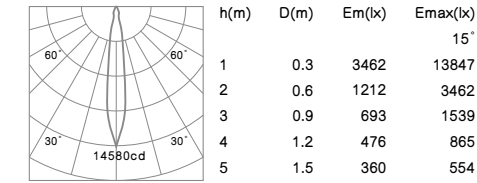

## R6291 30W 3000lm With LED Driver 36V-800mA 230V-50Hz

NW  
1.66kg

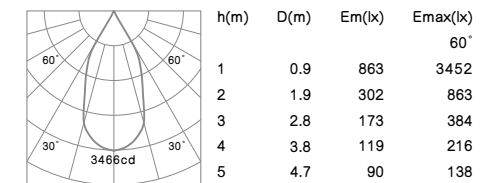
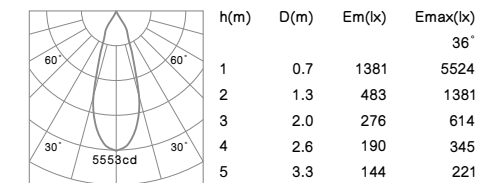
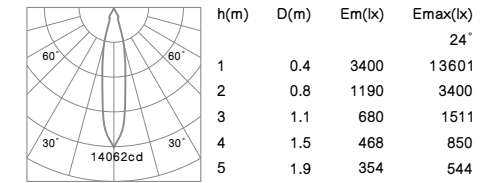
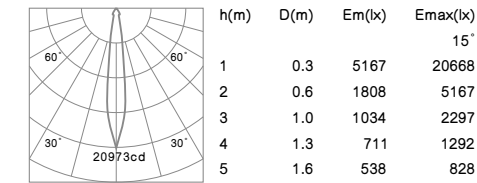

# RONO R L

**R6291 40W 3800lm**  
With LED Driver 36V-1050mA  
230V-50Hz

NW  
1.66kg

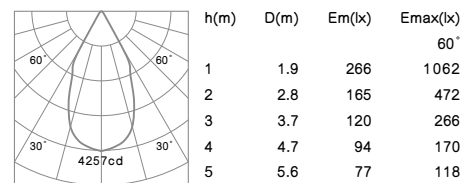
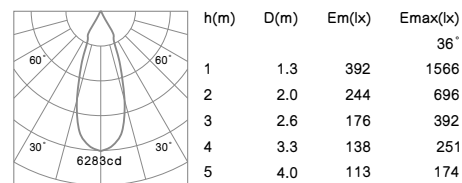
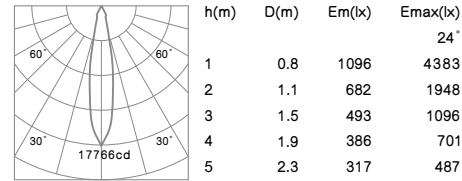
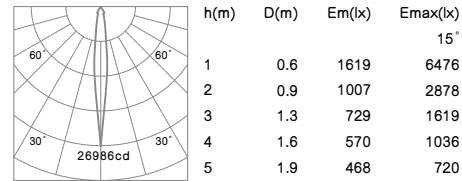

# RONO R L



**COB LED CRI≥80 IP20 CE RoHS**  
Mounting frame color: White Silver Black  
Color temperature: 2700K 3000K 4000K  
Beam angle: 15° 24° 36°

Driver gear for LED: Non-Dimmable  
1-10V Dimmable  
DALI Dimmable  
Triac Dimmable

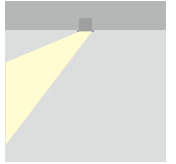

- Housing and mounting ring: Cast aluminum.
- The spot light tilts to a maximum of 0°-30° onto the vertical plane and rotates by 358° onto the horizontal plane.
- Anti-dazzle ring: Plastic black.
- Light source: COB LED with a high efficiency reflector of optical.
- The light can be compatible with emergency battery.

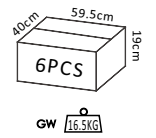
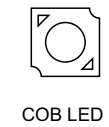
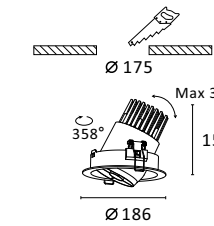

**R6292 20W 1400lm**  
With LED Driver 36V-500mA  
230V-50Hz

NW  
1.70kg

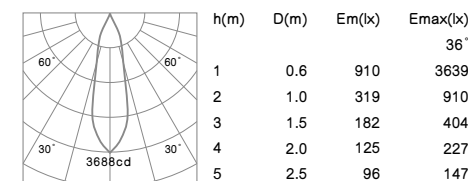
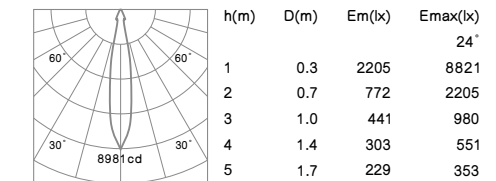
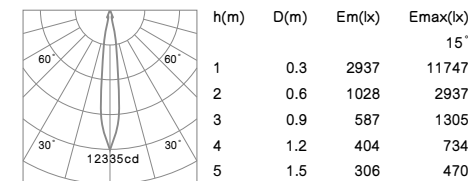

**R6292 25W 1600lm**  
With LED Driver 36V-600mA  
230V-50Hz

NW  
1.70kg

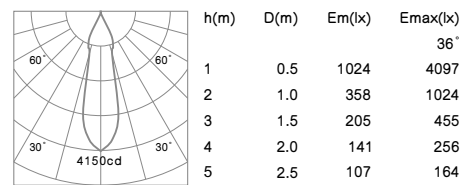
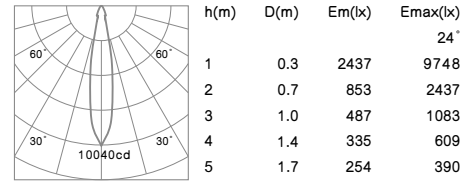
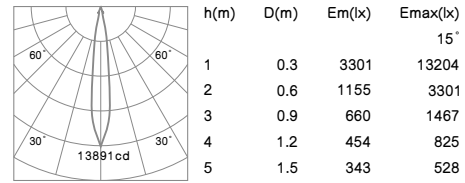

**R6292 30W 2300lm**  
With LED Driver 36V-800mA  
230V-50Hz

NW  
1.70kg

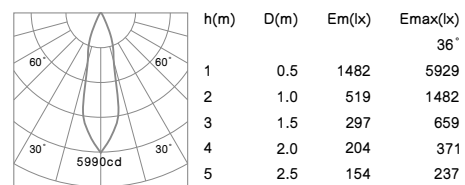
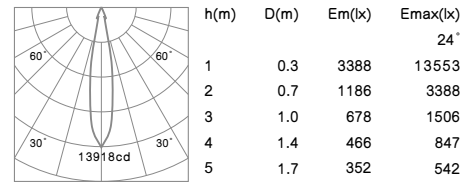
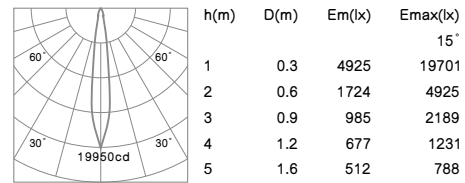

**R6292 40W 2900lm**  
With LED Driver 36V-1050mA  
230V-50Hz

NW  
1.70kg

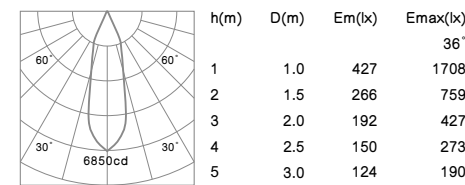
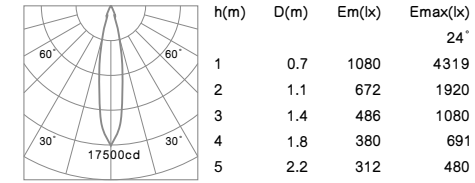
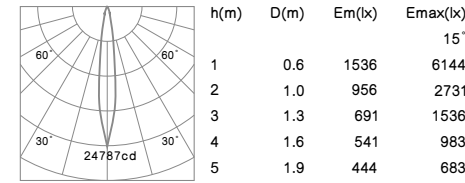



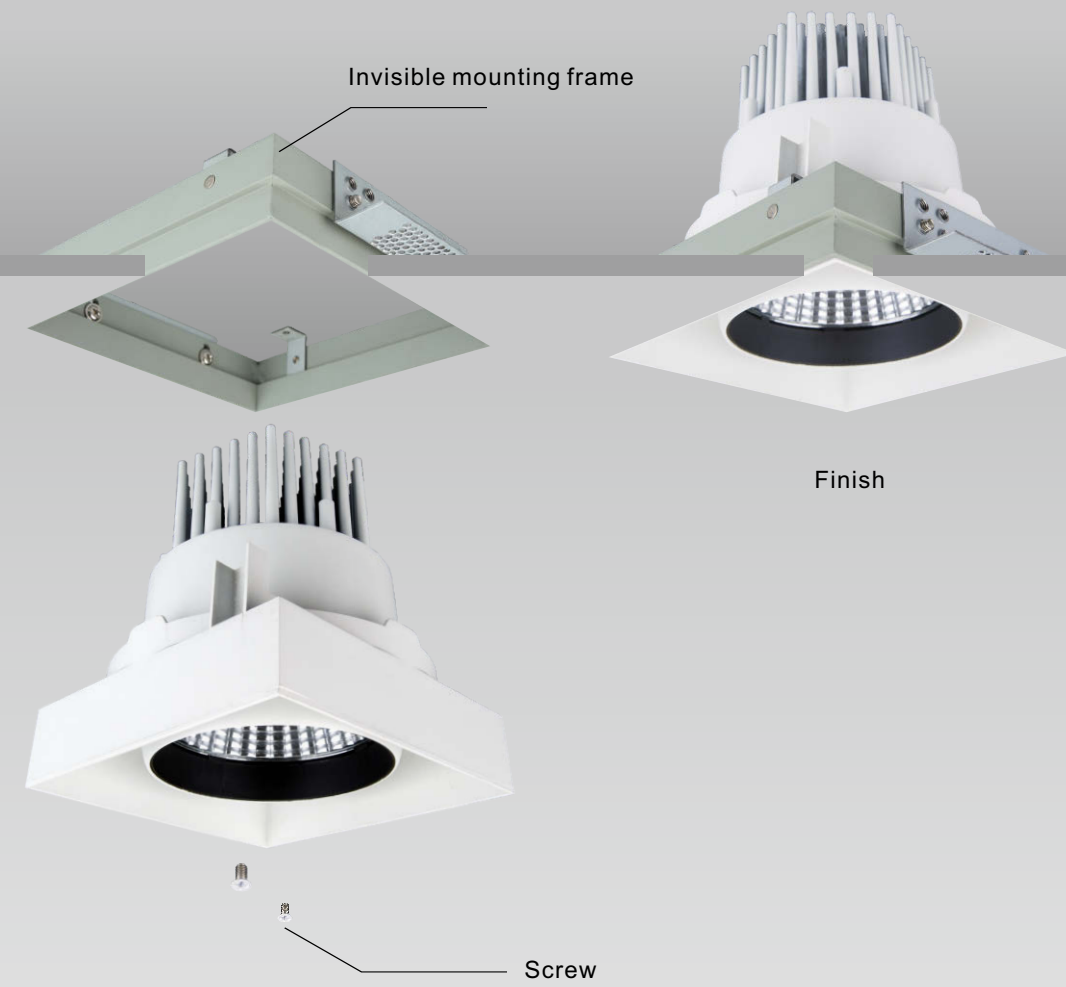

RONO S

15°

24°

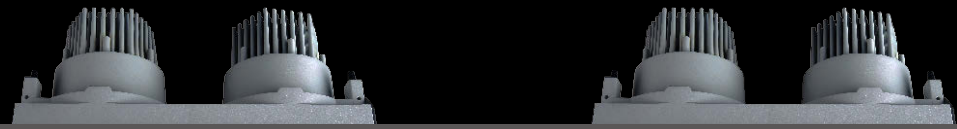

259

RONO S

36°

60°



260



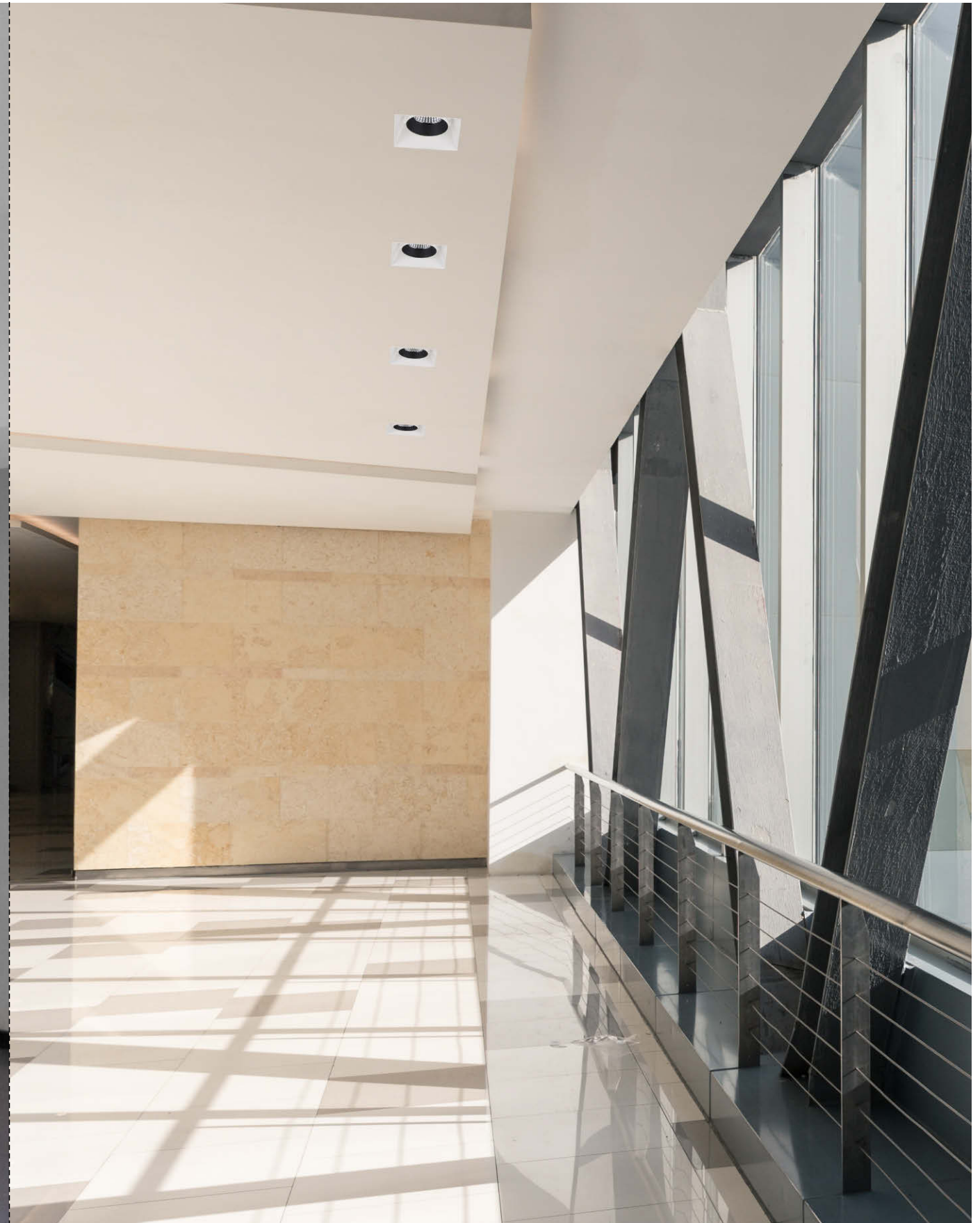

# RONO S

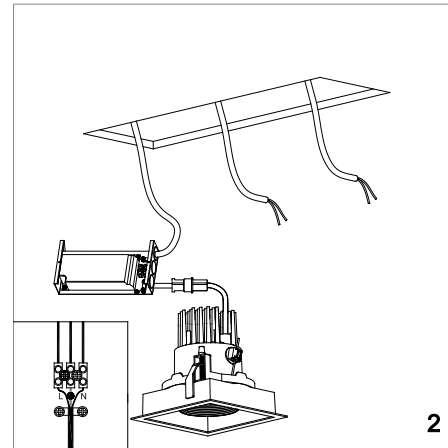
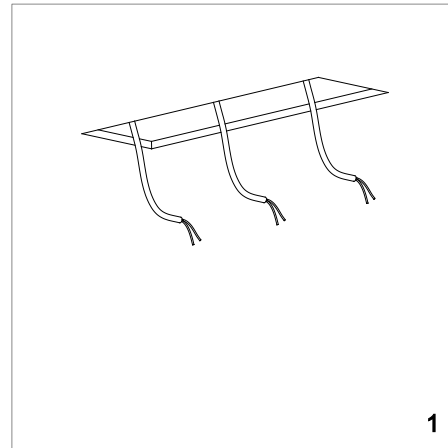

1  
Cut a mounting hole as required in the ceiling;

2  
Place the mounting frame into the hole of the ceiling;

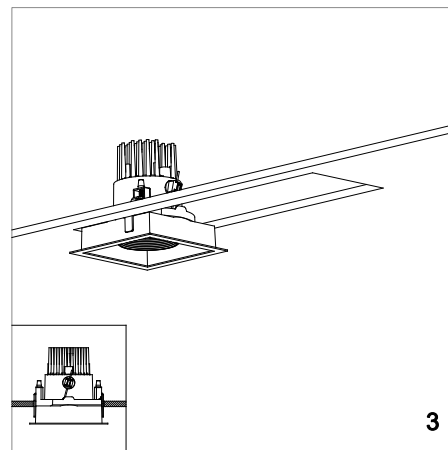

3  
Fix the mounting frame in the ceiling with screws;

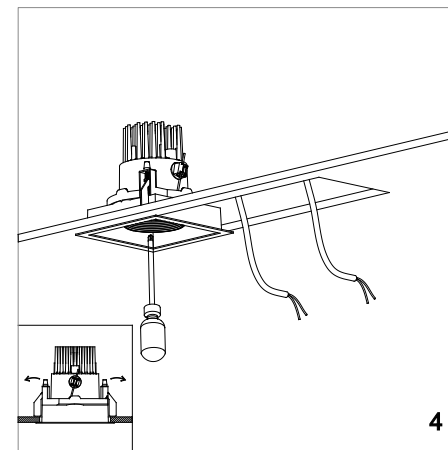

4  
Paint around the mounting hole to make the ceiling have a flat appearance;

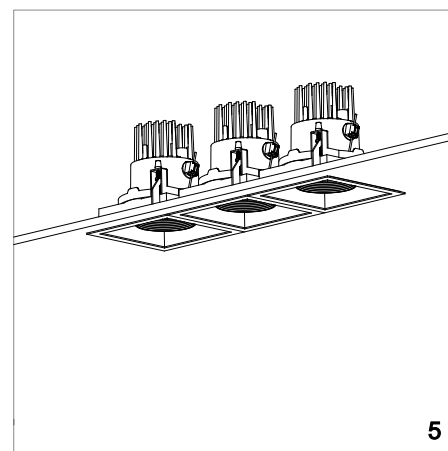

5  
Rotate the front ring anticlockwise and then take it out;

# RONO S



S □90x90mm 6W 10W 15W P265



M □145x145mm 20W 25W 30W 40W P267



M □145x145mm 20W 25W 30W 40W P269

## Invisible



L □168x168mm 20W 25W 30W 40W P271



LD □169x353mm 2x20W 2x25W 2x30W 2x40W P274



LT □169x537mm 3x20W 3x25W 3x30W 3x40W P277

## Visible



L □177x177mm 20W 25W 30W 40W P280



LD □177x361mm 2x20W 2x25W 2x30W 2x40W P283



LT □177x545mm 3x20W 3x25W 3x30W 3x40W P286





**COB LED CRI≥80 IP44 CE RoHS**  
 Mounting frame color: White Silver Black  
 Color temperature: 2700K 3000K 4000K  
 Beam angle: 24° 36° 60°

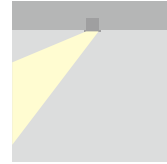

Driver gear for LED:  
 Non-Dimmable  
 1-10V Dimmable  
 DALI Dimmable  
 Triac Dimmable

- Housing and mounting frame: Cast aluminum.
- The spot light tilts to a maximum of 0°-30° onto the vertical plane.
- Anti-dazzle ring: Aluminum black.
- Light source: COB LED with a lens of optical.

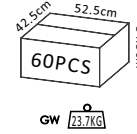
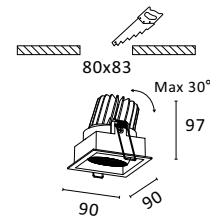

**R6925 6W 470lm**  
 With LED Driver 36V-135mA  
 230V-50Hz

NW  
 0.33kg

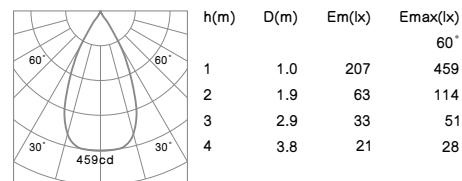
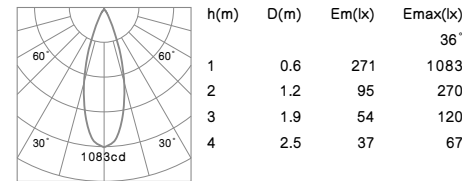
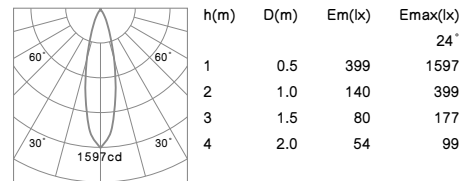

**R6925 10W 750lm**  
 With LED Driver 36V-250mA  
 230V-50Hz

NW  
 0.42kg

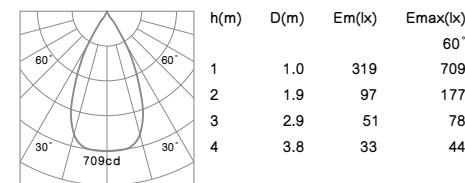
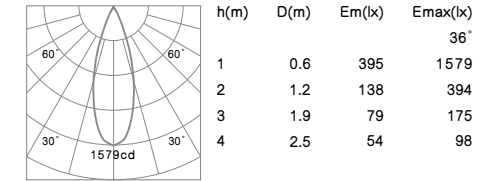
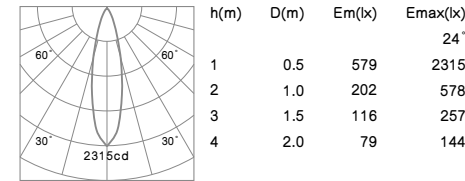

**R6925 15W 1060lm**  
 With LED Driver 36V-350mA  
 230V-50Hz

NW  
 0.42kg

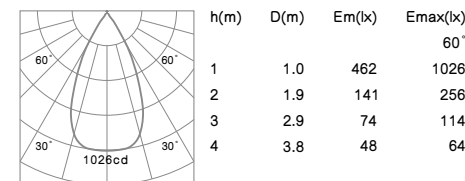
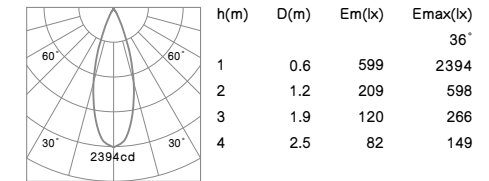
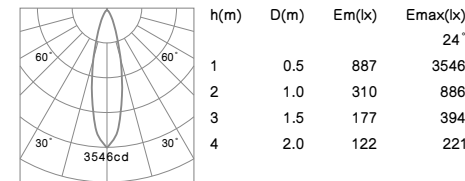

# RONO S M



**COB LED CRI≥80 IP20 CE RoHS**

Mounting frame color: White Silver Black  
 Color temperature: 2700K 3000K 4000K  
 Beam angle: 15° 24° 36° 60°

Driver gear for LED:  
 Non-Dimmable  
 1-10V Dimmable  
 DALI Dimmable  
 Triac Dimmable

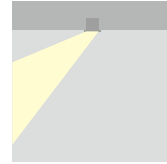

- Housing and mounting frame: Cast aluminum.
- The spot light tilts to a maximum of 0°-30° onto the vertical plane and rotates by 358° onto the horizontal plane.
- Anti-dazzle ring: Plastic black.
- Light source: COB LED with a high efficiency reflector of optical.
- The light can be compatible with emergency battery.

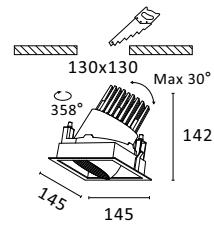

COB LED

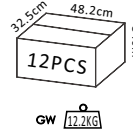

## R6087 15W 1300lm With LED Driver 36V-350mA 230V-50Hz

NW  
1.14kg

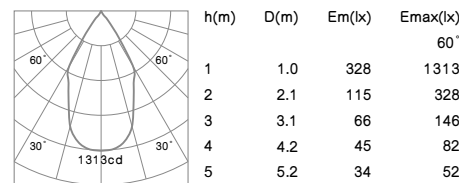
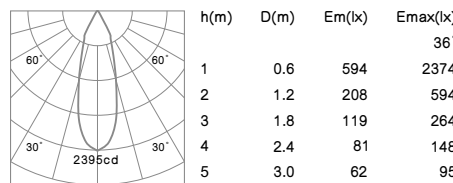
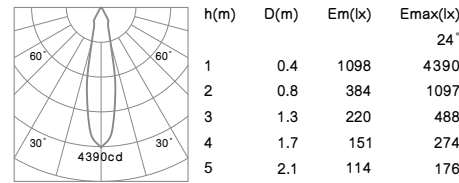
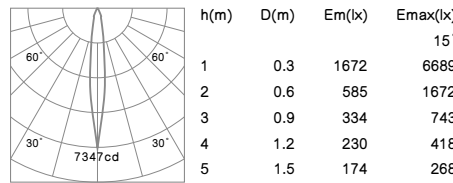

# RONO S M

## R6087 20W 1700lm With LED Driver 36V-500mA 230V-50Hz

NW  
1.14kg

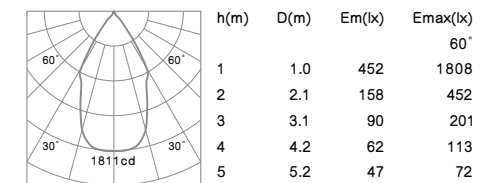
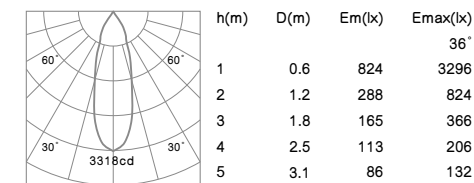
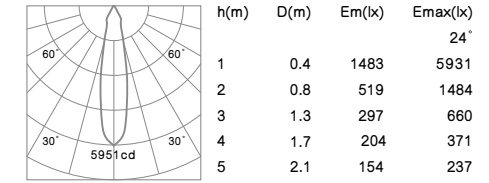
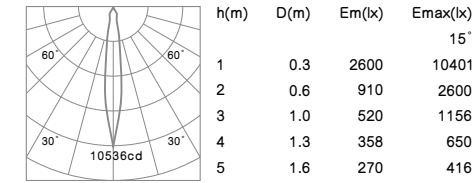

## R6087 25W 2000lm With LED Driver 36V-600mA 230V-50Hz

NW  
1.14kg

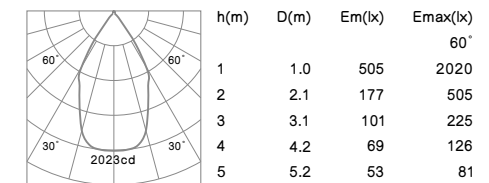
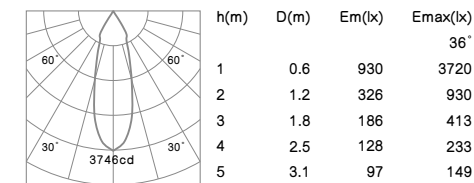
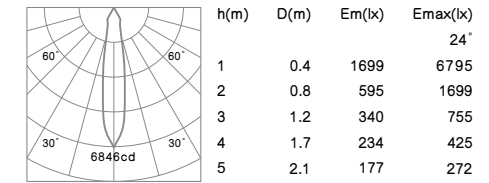
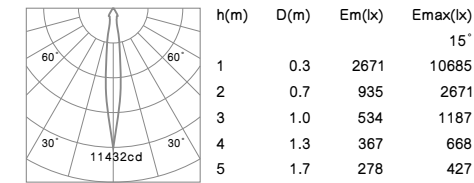

# RONO S M



**COB LED CRI≥80 IP20 CE RoHS**  
 Mounting frame color: White Silver Black  
 Color temperature: 2700K 3000K 4000K  
 Beam angle: 15° 24° 36°

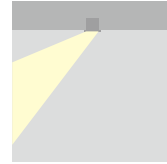

Driver gear for LED:  
 Non-Dimmable  
 1-10V Dimmable  
 DALI Dimmable  
 Triac Dimmable

- Housing and mounting frame: Cast aluminum.
- The spot light tilts to a maximum of 0°-30° onto the vertical plane and rotates by 358° onto the horizontal plane.
- Anti-dazzle ring: Plastic black.
- Light source: COB LED with a high efficiency reflector of optical.
- The light can be compatible with emergency battery.

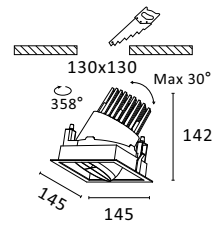

COB LED

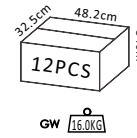

## R6089 15W 900lm With LED Driver 36V-350mA 230V-50Hz

NW  
1.17kg

h(m)	D(m)	Em(lx)	Emax(lx)
1	0.3	1690	6758
2	0.6	591	1689
3	0.9	338	751
4	1.2	232	422
5	1.5	176	270

h(m)	D(m)	Em(lx)	Emax(lx)
1	0.4	960	3838
2	0.7	336	960
3	1.1	192	427
4	1.5	132	240
5	1.8	100	154

h(m)	D(m)	Em(lx)	Emax(lx)
1	0.5	535	2138
2	1.1	187	535
3	1.6	107	238
4	2.2	74	134
5	2.7	56	86

h(m)	D(m)	Em(lx)	Emax(lx)
1	0.4	960	3838
2	0.7	336	960
3	1.1	192	427
4	1.5	132	240
5	1.8	100	154

# RONO S M

## R6089 20W 1200lm With LED Driver 36V-500mA 230V-50Hz

NW  
1.17kg

h(m)	D(m)	Em(lx)	Emax(lx)
1	0.3	2365	9460
2	0.6	828	2365
3	1.0	473	1051
4	1.3	325	591
5	1.6	246	378

h(m)	D(m)	Em(lx)	Emax(lx)
1	0.4	1299	5194
2	0.8	455	1299
3	1.2	260	577
4	1.6	179	325
5	2.0	135	208

h(m)	D(m)	Em(lx)	Emax(lx)
1	0.6	722	2886
2	1.1	253	722
3	1.7	144	321
4	2.2	99	180
5	2.8	75	115

## R6089 25W 1400lm With LED Driver 36V-600mA 230V-50Hz

NW  
1.17kg

h(m)	D(m)	Em(lx)	Emax(lx)
1	0.3	2660	10640
2	0.6	931	2660
3	1.0	532	1182
4	1.3	366	665
5	1.6	277	426

h(m)	D(m)	Em(lx)	Emax(lx)
1	0.4	1465	5861
2	0.8	513	1465
3	1.2	293	651
4	1.6	201	366
5	2.0	152	234

h(m)	D(m)	Em(lx)	Emax(lx)
1	0.5	829	3317
2	1.0	290	829
3	1.6	166	369
4	2.2	114	207
5	2.7	86	133

# RONO S Invisible L



**COB LED CRI≥80 IP20 CE RoHS**

Mounting frame color: White Silver Black  
 Color temperature: 2700K 3000K 4000K  
 Beam angle: 15° 24° 36° 60°

Driver gear for LED:  
 Non-Dimmable  
 1-10V Dimmable  
 DALI Dimmable  
 Triac Dimmable

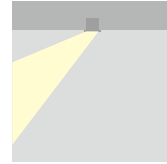

- This fixture has one mounting frame which is made of steel sheet.
- Mounting frame kit: Cast aluminum, for flush-mounting installation in plasterboard ceilings.
- The spot light tilts to a maximum of 0°-30° onto the vertical plane and rotates by 358° onto the horizontal plane.
- Anti-dazzle ring: Plastic black.
- Light source: COB LED with a high efficiency reflector of optical.
- The light can be compatible with emergency battery.

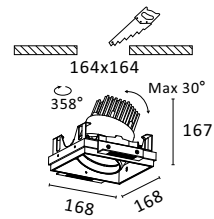

COB LED

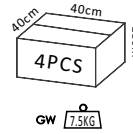

## R6231 20W 1800lm With LED Driver 36V-500mA 230V-50Hz

NW  
1.40kg

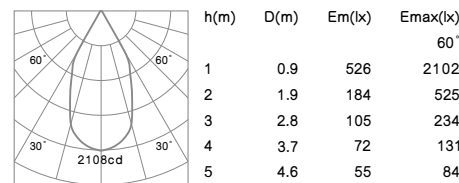
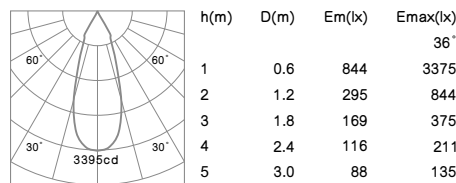
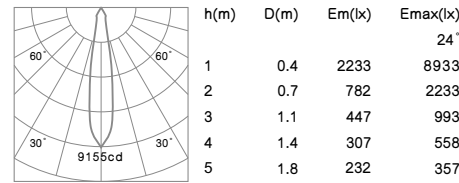
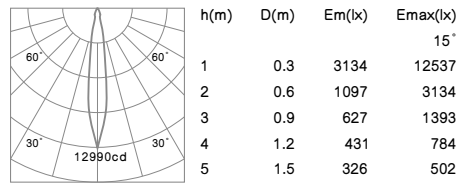

# RONO S Invisible L

## R6231 25W 2100lm With LED Driver 36V-600mA 230V-50Hz

NW  
1.40kg

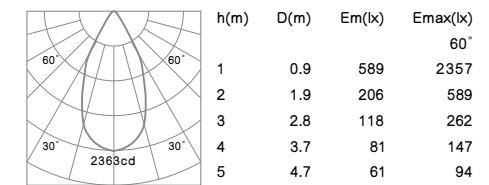
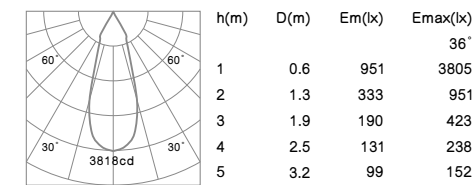
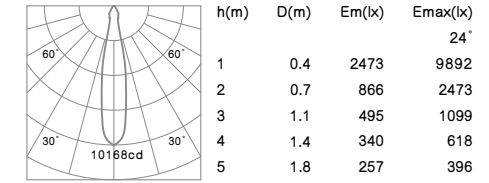
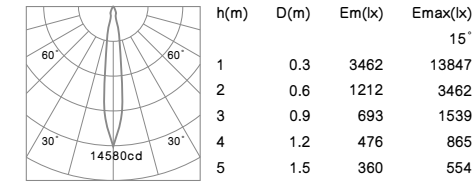

## R6231 30W 3000lm With LED Driver 36V-800mA 230V-50Hz

NW  
1.40kg

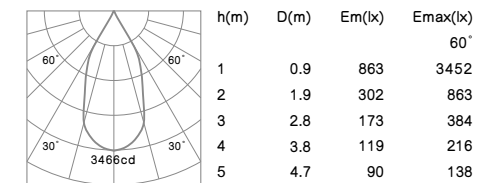
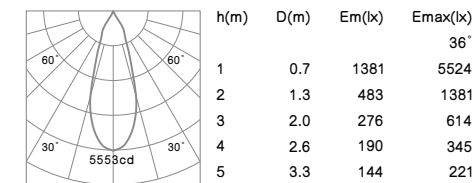
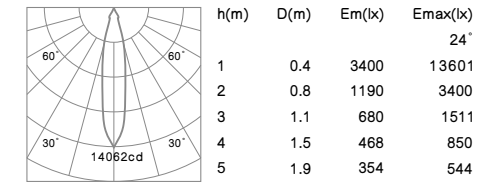
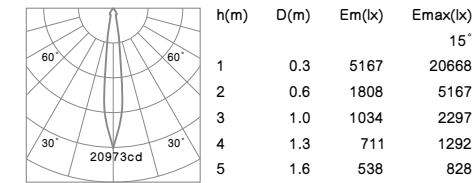



# RONO S Invisible L

R6231 40W 3800lm  
With LED Driver 36V-1050mA  
230V-50Hz

NW  
1.40kg

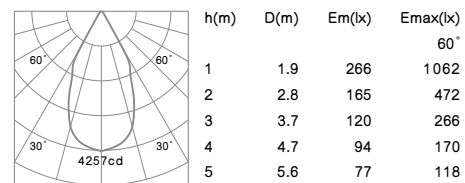
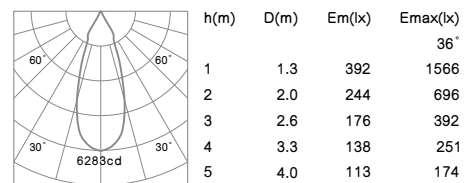
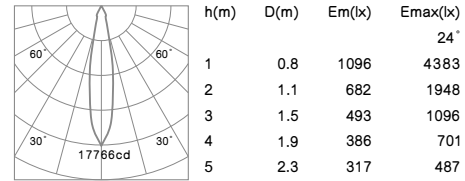
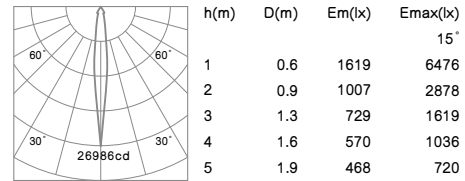

# RONO S Invisible LD



**COB LED** **CRi≥80** **IP20** **CE** **RoHS**

Mounting frame color: White Silver Black  
Color temperature: 2700K 3000K 4000K  
Beam angle: 15° 24° 36° 60°

Driver gear for LED: Non-Dimmable  
1-10V Dimmable  
DALI Dimmable  
Triac Dimmable

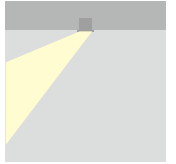

- This fixture has one mounting frame which is made of steel sheet.
- Mounting frame kit: Cast aluminum, for flush-mounting installation in plasterboard ceilings.
- The spot light tilts to a maximum of 0°-30° onto the vertical plane and rotates by 358° onto the horizontal plane.
- Anti-dazzle ring: Plastic black.
- Light source: COB LED with a high efficiency reflector of optical.
- The light can be compatible with emergency battery.

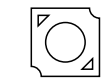
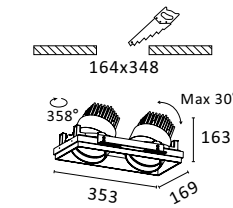

COB LED

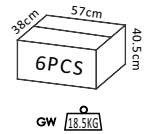

GW 18.5kg

R6232 2x20W 3600lm  
With 2 pieces of LED Driver 36V-500mA  
230V-50Hz

NW  
2.72kg

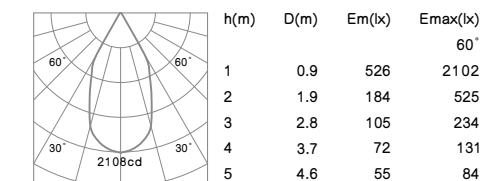
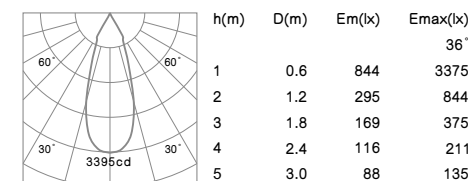
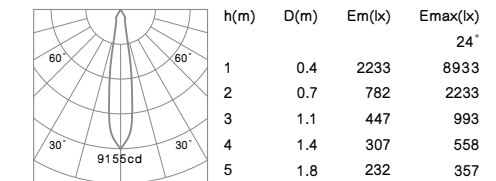
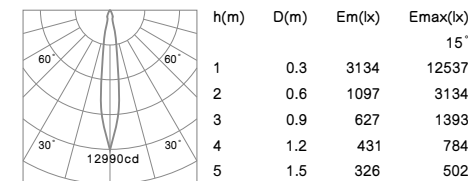

R6232 2x25W 4200lm  
With 2 pieces of LED Driver 36V-600mA  
230V-50Hz

NW  
2,72kg

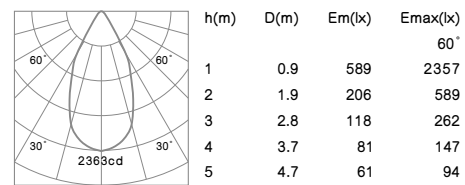
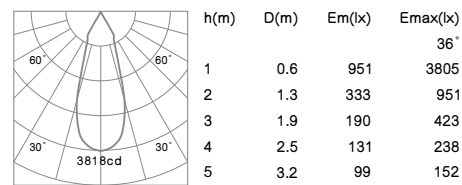
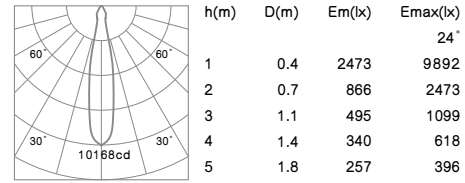
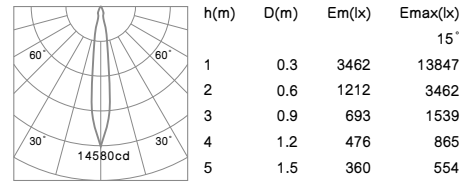

R6232 2x30W 6000lm  
With 2 pieces of LED Driver 36V-800mA  
230V-50Hz

NW  
2,72kg

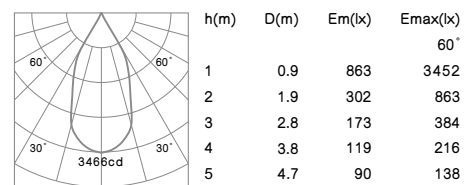
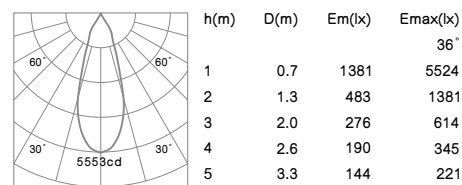
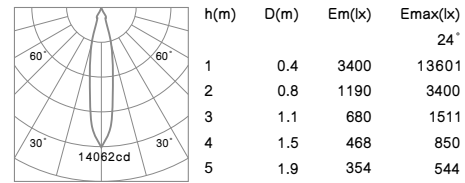
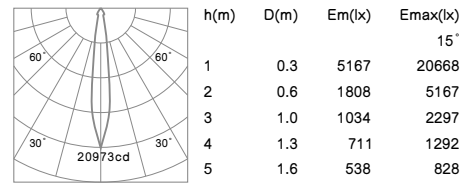

R6232 2x40W 7600lm  
With 2 pieces of LED Driver 36V-1050mA  
230V-50Hz

NW  
2,72kg

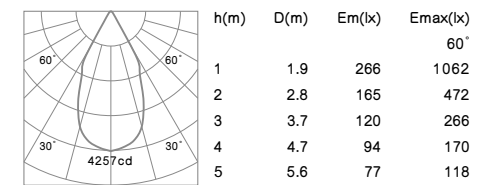
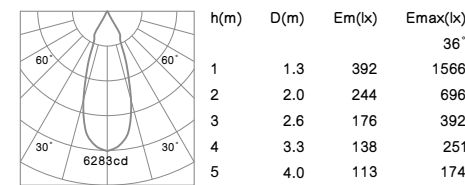
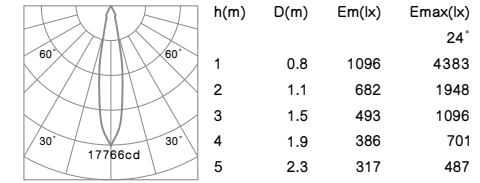
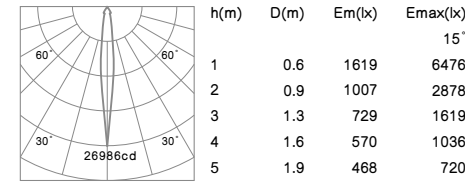

# RONO S Invisible LT



**COB LED CRI≥80 IP20 CE RoHS**  
 Mounting frame color: White Silver Black  
 Color temperature: 2700K 3000K 4000K  
 Beam angle: 15° 24° 36° 60°

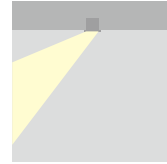

Driver gear for LED:  
 Non-Dimmable  
 1-10V Dimmable  
 DALI Dimmable  
 Triac Dimmable

- This fixture has one mounting frame which is made of steel sheet.
- Mounting frame kit: Cast aluminum, for flush-mounting installation in plasterboard ceilings.
- The spot light tilts to a maximum of 0°-30° onto the vertical plane and rotates by 358° onto the horizontal plane.
- Anti-dazzle ring: Plastic black.
- Light source: COB LED with a high efficiency reflector of optical.
- The light can be compatible with emergency battery.

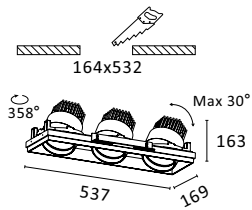

COB LED

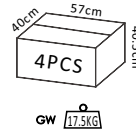

## R6233 3x20W 5400lm

With 3 pieces of LED Driver 36V-500mA  
 230V-50Hz

NW  
 3.94kg

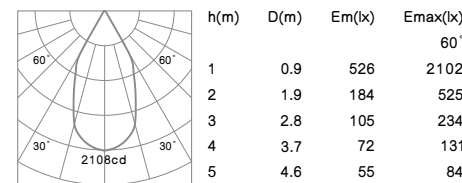
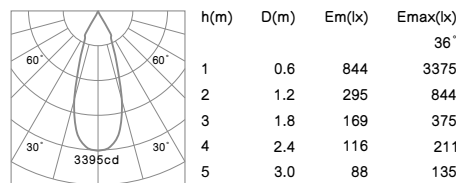
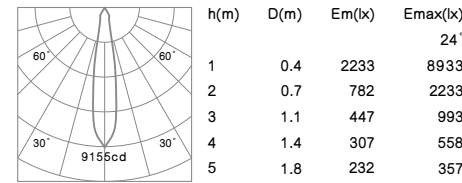
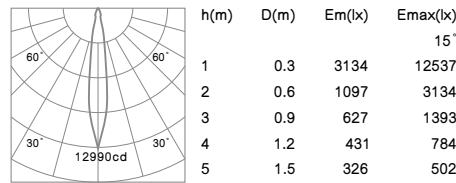

# RONO S Invisible LT

## R6233 3x25W 6300lm

With 3 pieces of LED Driver 36V-600mA  
 230V-50Hz

NW  
 3.94kg

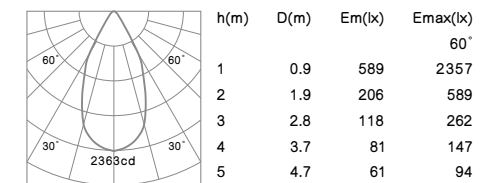
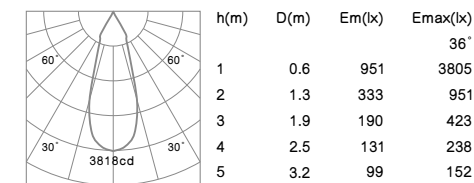
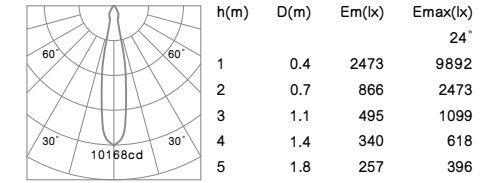
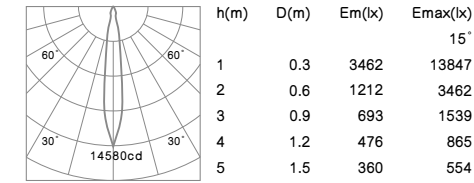

## R6233 3x30W 9000lm

With 3 pieces of LED Driver 36V-800mA  
 230V-50Hz

NW  
 3.94kg

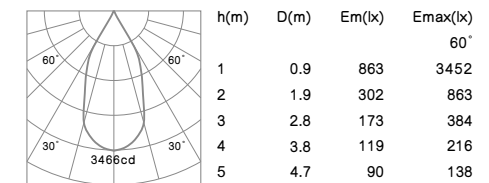
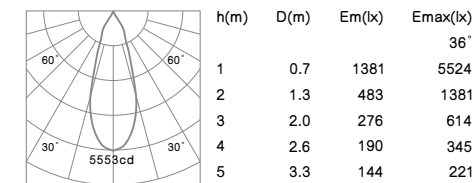
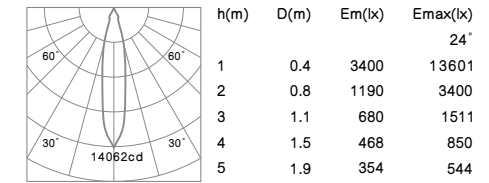
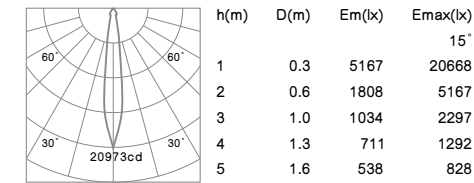

# RONO S Invisible LT

R6233 3x40W 11400lm  
With 3 pieces of LED Driver 36V-1050mA  
230V-50Hz

NW  
3,94kg

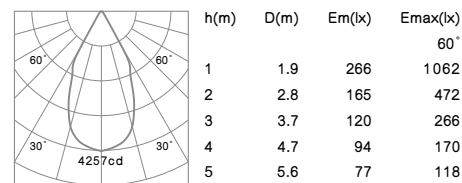
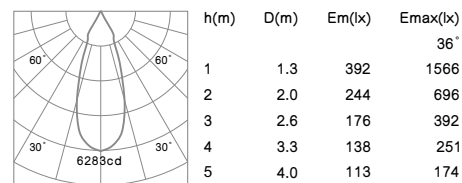
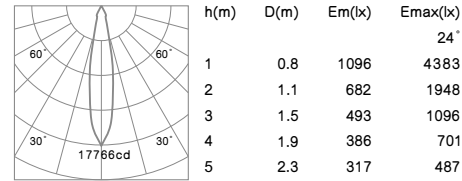
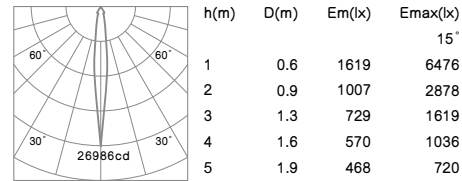

# RONO S Visible LS



COB LED CRI≥80 IP20 CE RoHS

Mounting frame color: White Silver Black  
Color temperature: 2700K 3000K 4000K  
Beam angle: 15° 24° 36° 60°

Driver gear for LED: Non-Dimmable  
1-10V Dimmable  
DALI Dimmable  
Triac Dimmable

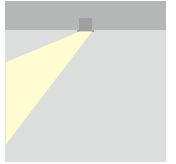

- Housing and mounting frame: Cast aluminum.
- The spot light tilts to a maximum of 0°-30° onto the vertical plane and rotates by 358° onto the horizontal plane.
- Anti-dazzle ring: Plastic black.
- Light source: COB LED with a high efficiency reflector of optical.
- The light can be compatible with emergency battery.

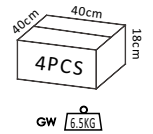
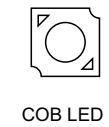
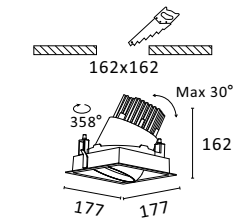

R6235 20W 1800lm  
With LED Driver 36V-500mA  
230V-50Hz

NW  
1,54kg

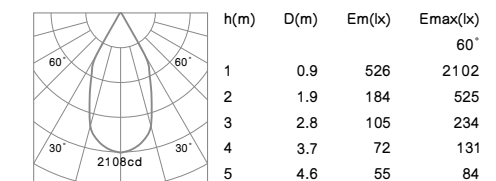
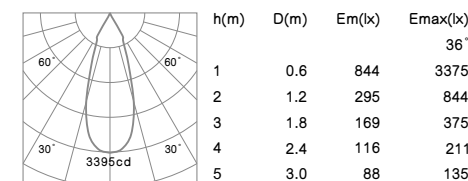
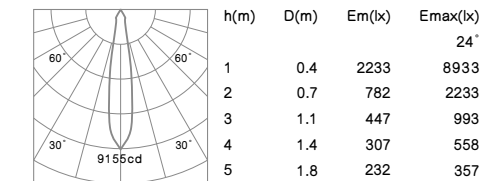
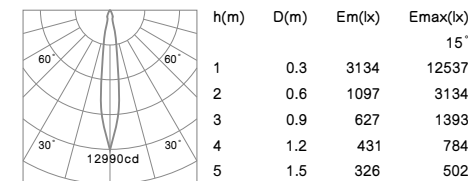



R6235 25W 2100lm  
With LED Driver 36V-600mA  
230V-50Hz

NW  
1.54kg

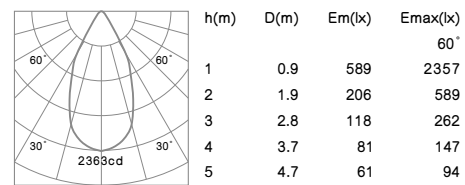
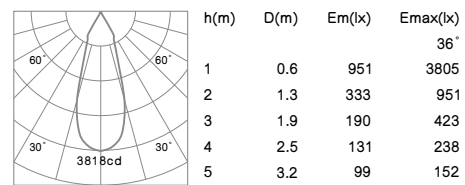
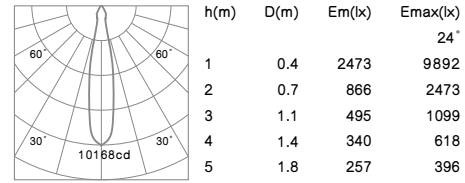
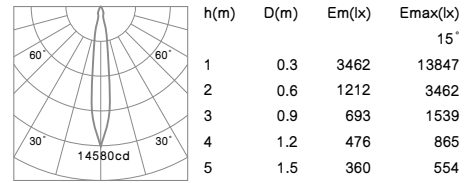

R6235 30W 3000lm  
With LED Driver 36V-800mA  
230V-50Hz

NW  
1.54kg

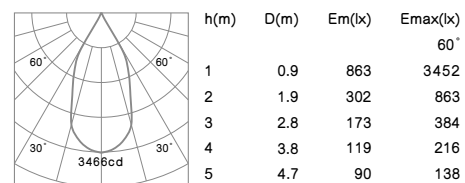
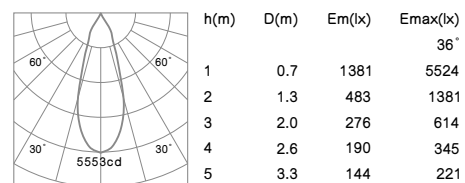
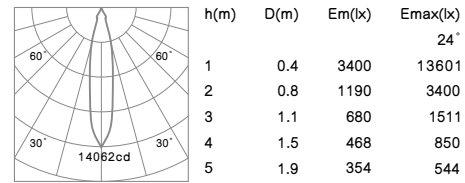
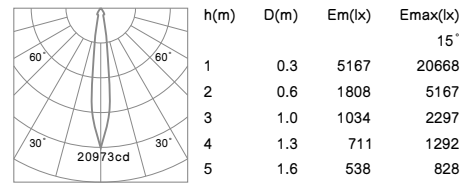

R6235 40W 3800lm  
With LED Driver 36V-1050mA  
230V-50Hz

NW  
1.54kg

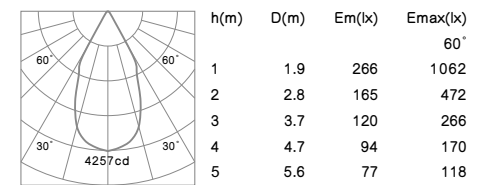
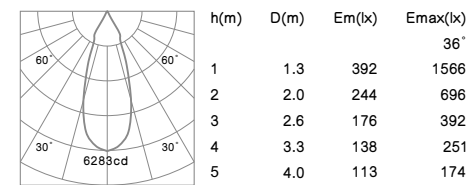
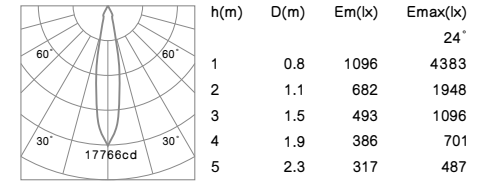
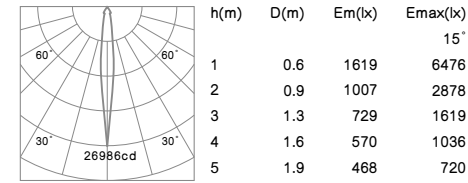

# RONO S Visible LD



**COB LED CRI≥80 IP20 CE RoHS**  
 Mounting frame color: White Silver Black  
 Color temperature: 2700K 3000K 4000K  
 Beam angle: 15° 24° 36° 60°

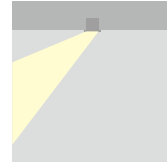

Driver gear for LED:  
 Non-Dimmable  
 1-10V Dimmable  
 DALI Dimmable  
 Triac Dimmable

- Housing and mounting frame: Cast aluminum.
- The spot light tilts to a maximum of 0°-30° onto the vertical plane and rotates by 358° onto the horizontal plane.
- Anti-dazzle ring: Plastic black.
- Light source: COB LED with a high efficiency reflector of optical.
- The light can be compatible with emergency battery.

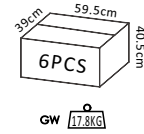
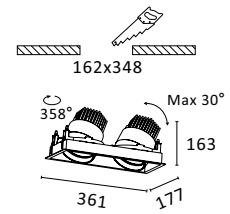

## R6236 2x20W 3600lm With 2 pieces of LED Driver 36V-500mA 230V-50Hz

NW  
 2.93kg

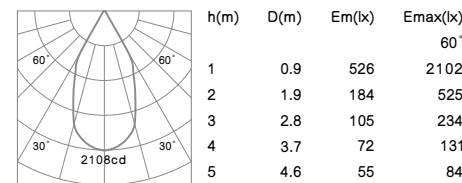
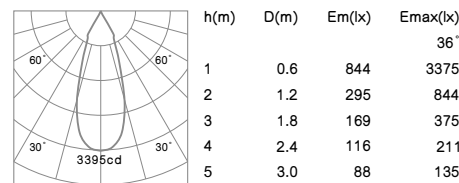
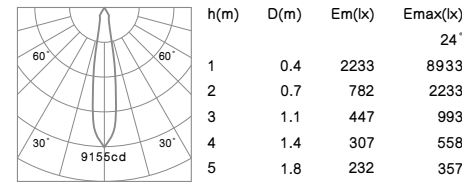
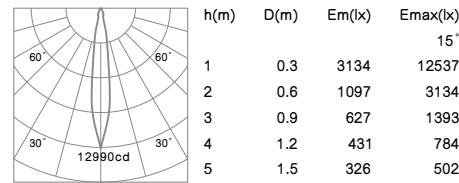

# RONO S Visible LD

## R6236 2x25W 4200lm With 2 pieces of LED Driver 36V-600mA 230V-50Hz

NW  
 2.93kg

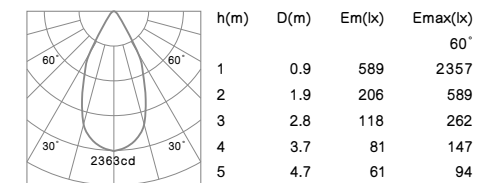
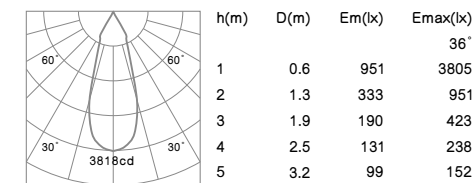
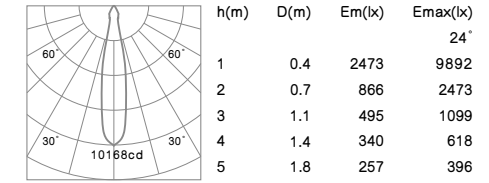
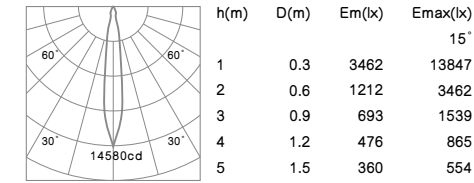

## R6236 2x30W 6000lm With 2 pieces of LED Driver 36V-800mA 230V-50Hz

NW  
 2.93kg

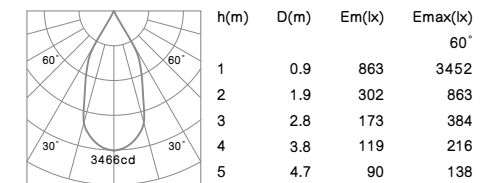
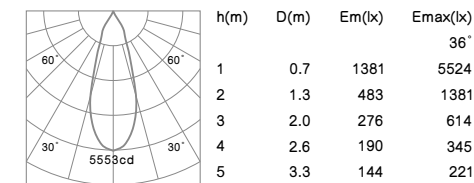
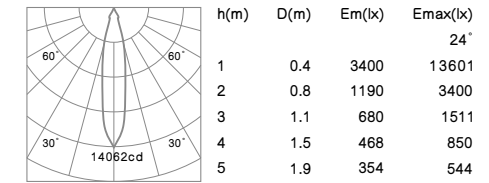
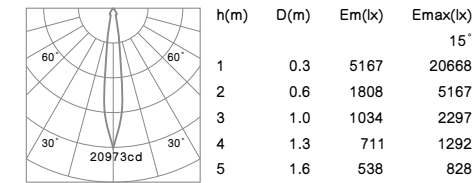

RONO S Visible LD

R6236 2x40W 7600lm  
With 2 pieces of LED Driver 36V-1050mA  
230V-50Hz

NW  
2.93kg

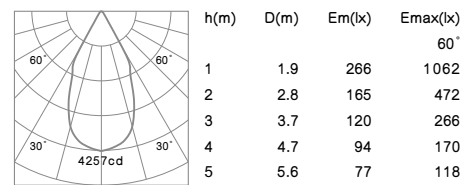
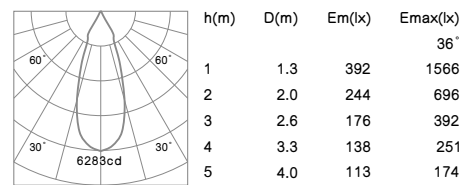
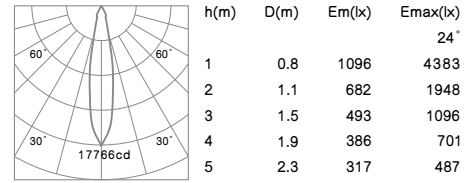
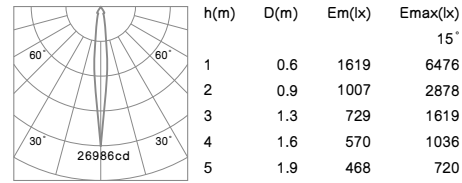

RONO S Visible LT



COB LED CRI≥80 IP20 CE RoHS

Mounting frame color: White Silver Black  
Color temperature: 2700K 3000K 4000K  
Beam angle: 15° 24° 36° 60°

Driver gear for LED: Non-Dimmable  
1-10V Dimmable  
DALI Dimmable  
Triac Dimmable

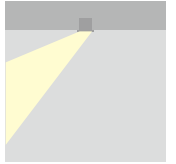

- Housing and mounting frame: Cast aluminum.
- The spot light tilts to a maximum of 0°-30° onto the vertical plane and rotates by 358° onto the horizontal plane.
- Anti-dazzle ring: Plastic black.
- Light source: COB LED with a high efficiency reflector of optical.
- The light can be compatible with emergency battery.

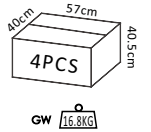
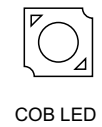
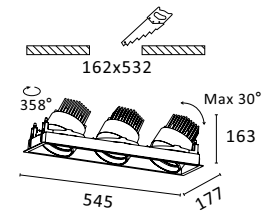

R6237 3x20W 5400lm  
With 3 pieces of LED Driver 36V-500mA  
230V-50Hz

NW  
4.23kg

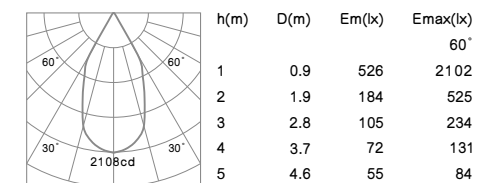
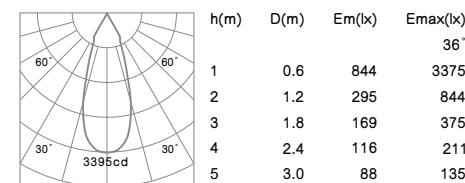
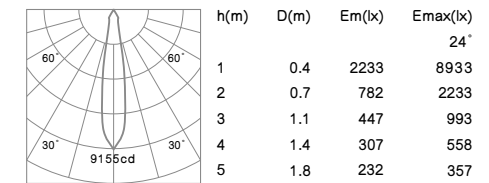
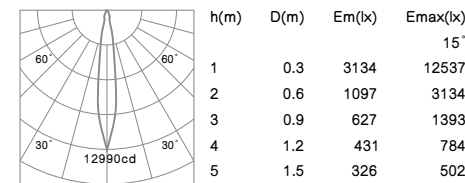

R6237 3x25W 6300lm  
With 3 pieces of LED Driver 36V-600mA  
230V-50Hz

NW  
4.23kg

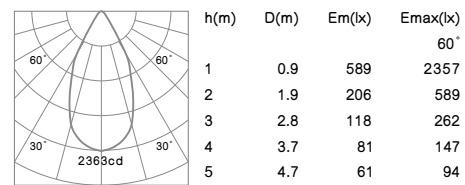
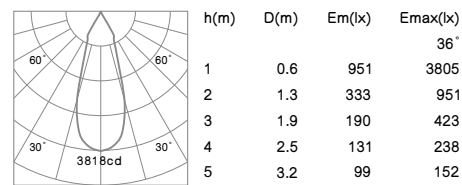
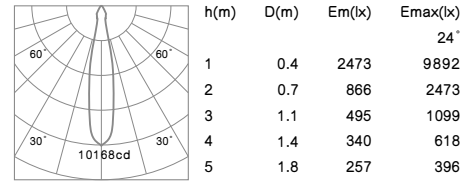
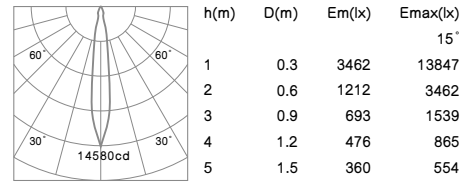

R6237 3x30W 9000lm  
With 3 pieces of LED Driver 36V-800mA  
230V-50Hz

NW  
4.23kg

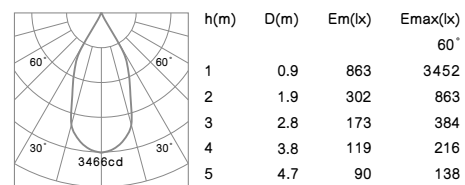
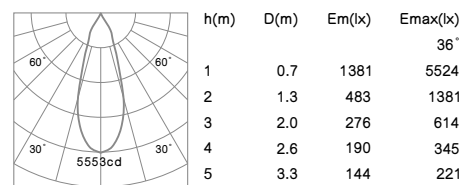
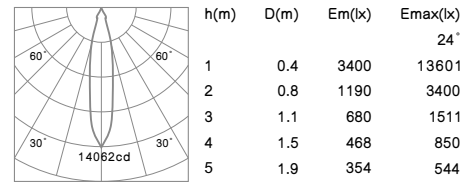
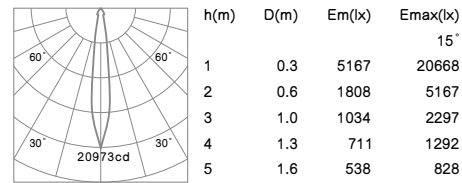

R6237 3x40W 11400lm  
With 3 pieces of LED Driver 36V-1050mA  
230V-50Hz

NW  
4.23kg

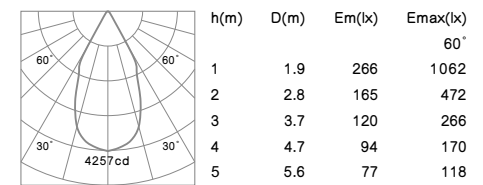
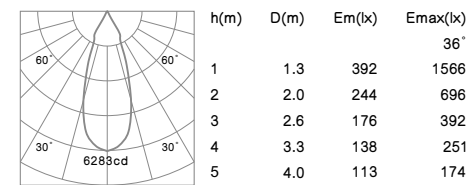
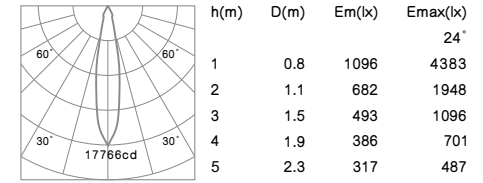
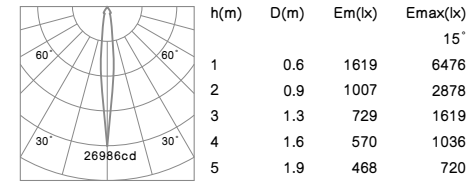



FUTW



FUTW



Installed

- 1/ Cut a hole
- 2/ Install the trimless mounting frame in the hole

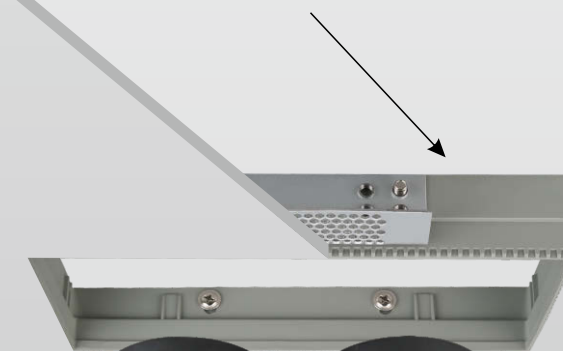

- 3/ Insert the lamp and tighten the screws

FUTW

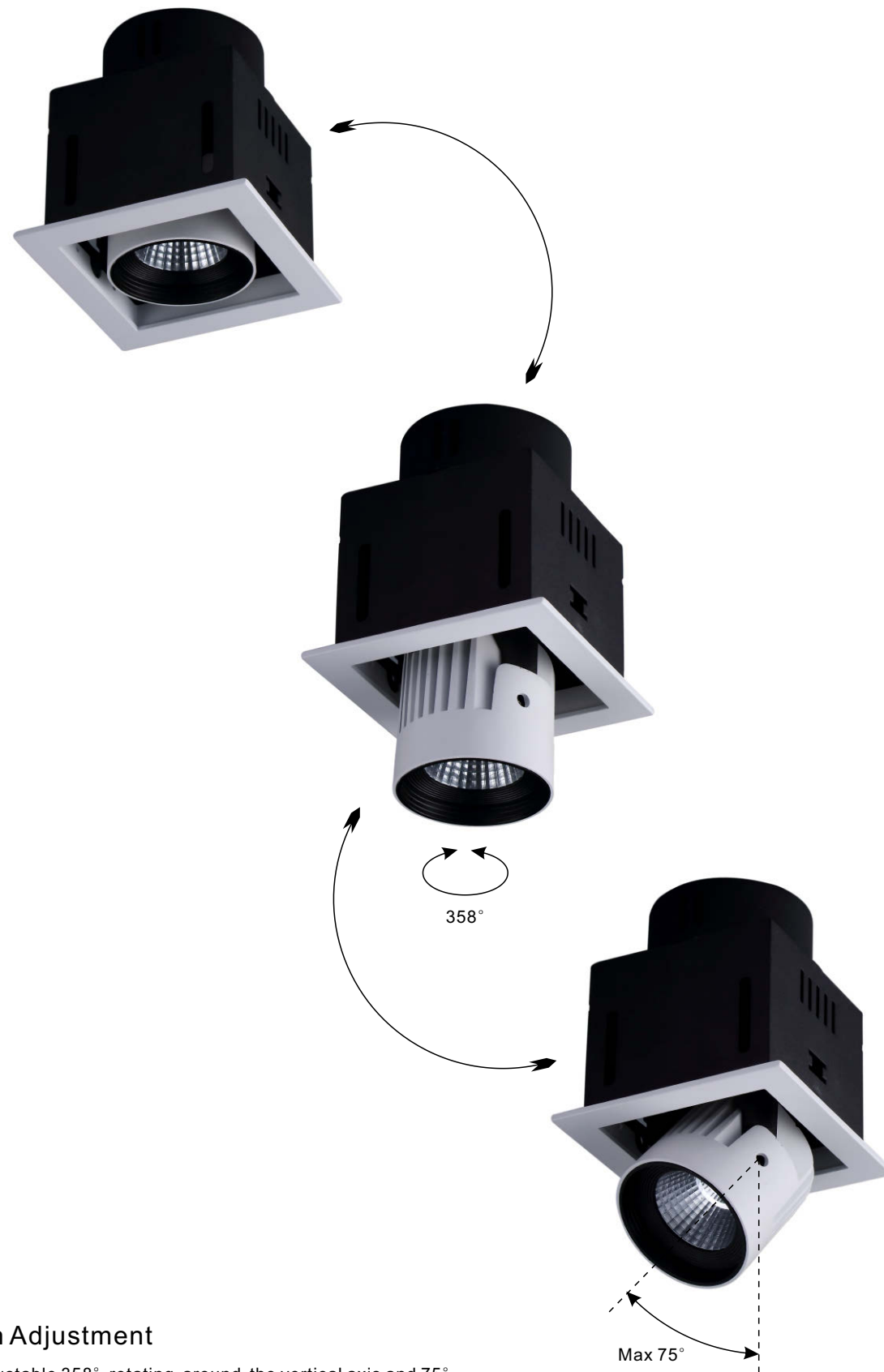

#### Direction Adjustment

Spotlight adjustable 358° rotating around the vertical axis and 75° rotating around the horizontal axis.

FUTW

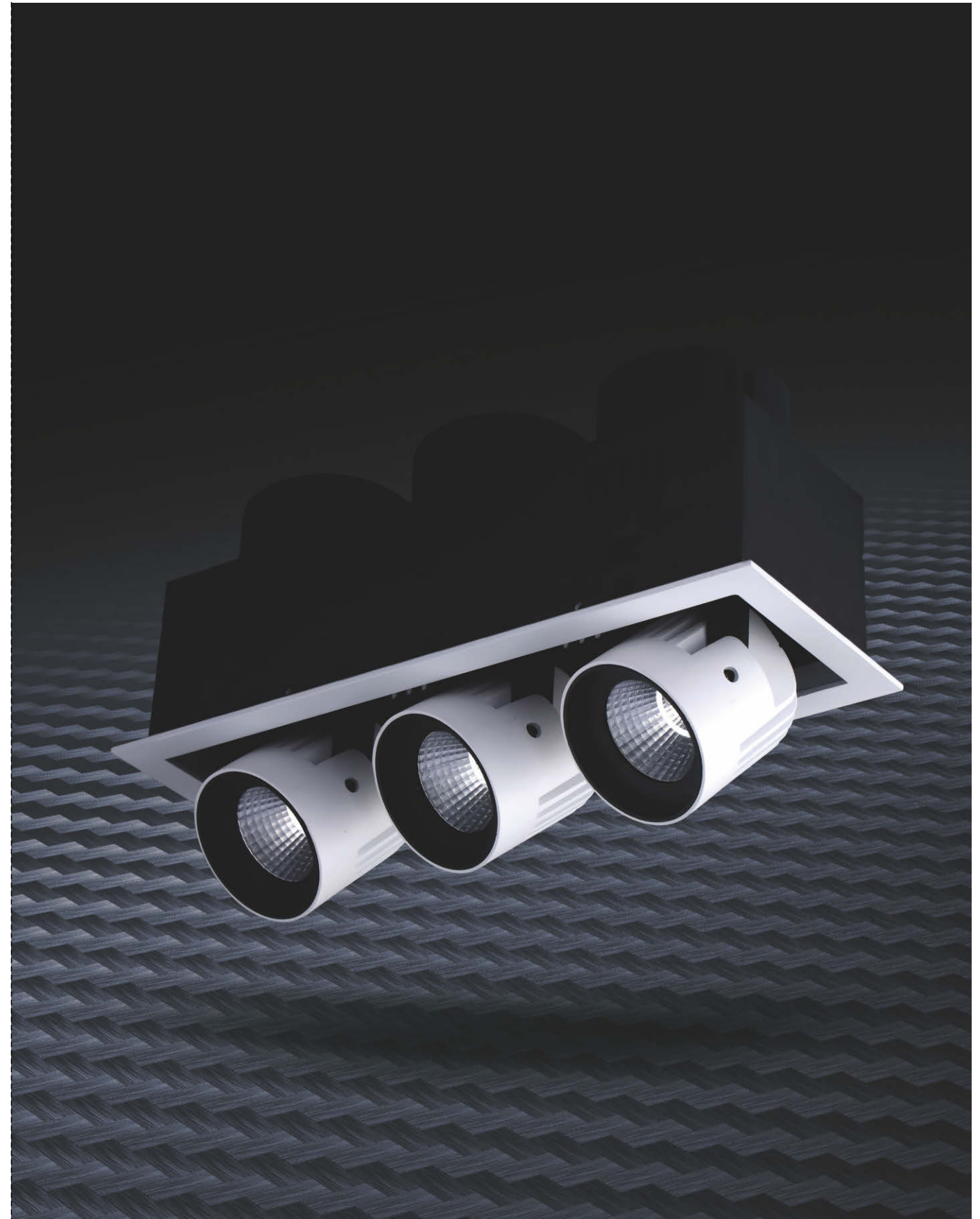







## FUTW

### Invisible



□ 110x110mm 10W 15W 20W

P297



□ 215x110mm 2x10W 2x15W 2x20W

P299



□ 307x110mm 3x10W 3x15W 3x20W

P301

### Visible



∅ 110mm 10W 15W 20W

P303



□ 118x118mm 10W 15W 20W

P305



□ 224x118mm 2x10W 2x15W 2x20W

P307



□ 315x118mm 3x10W 3x15W 3x20W

P309

## FUTW

### Surface-mounted



∅ 125x165mm 10W 15W 20W

P311



□ 120x120x165mm 10W 15W 20W

P313



# FUTW Invisible



**COB LED CRI≥80 IP20 CE RoHS**

Mounting frame color: White Silver Black  
 Color temperature: 2700K 3000K 4000K  
 Beam angle: 15° 24° 36° 60°

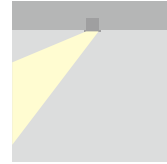

Driver gear for LED:  
 Non-Dimmable  
 1-10V Dimmable  
 DALI Dimmable  
 Triac Dimmable

- Housing and bracket: Cast aluminum + steel sheet.
- Spotlight adjustable 358° rotating around the vertical axis and 75° rotating around the horizontal axis.
- Anti-dazzle ring: Plastic black.
- Light spot pipe is available, which could make the light more soft and more perfect.
- Light source: COB LED with a high efficiency reflector of optical.
- The light can be compatible with emergency battery.
- Mounting fixed kit: Cast aluminum, for flush-mounting installation in plasterboard ceilings.

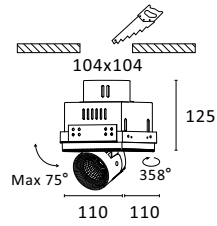

COB LED

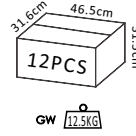

## R6360 10W 1050lm With LED Driver 36V-250mA 230V-50Hz

NW  
0.90kg

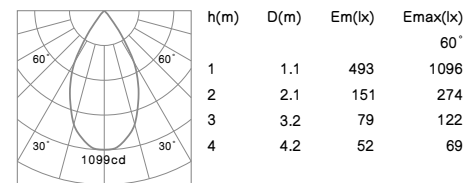
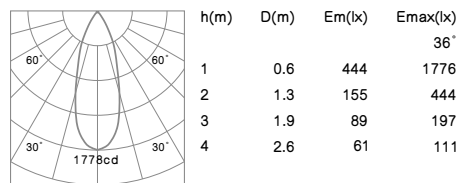
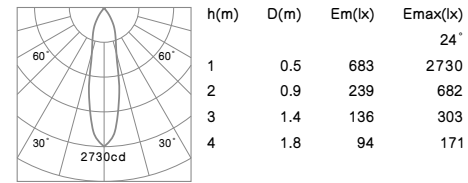
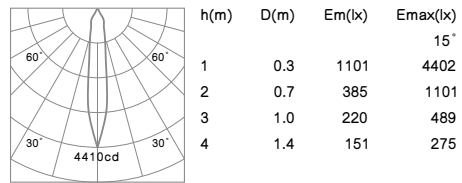

# FUTW Invisible

## R6360 15W 1370lm With LED Driver 36V-350mA 230V-50Hz

NW  
0.90kg

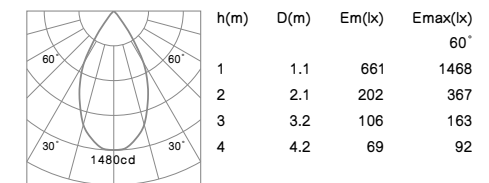
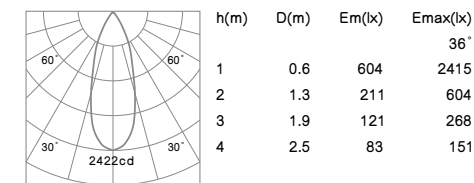
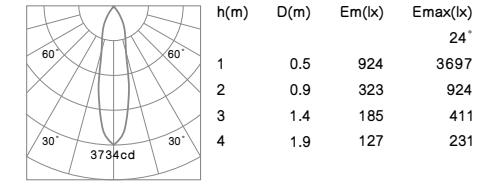
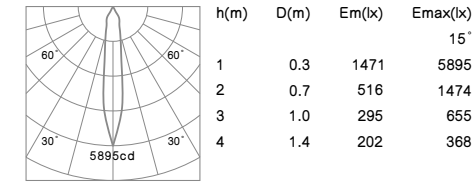

## R6360 20W 1850lm With LED Driver 36V-500mA 230V-50Hz

NW  
0.90kg

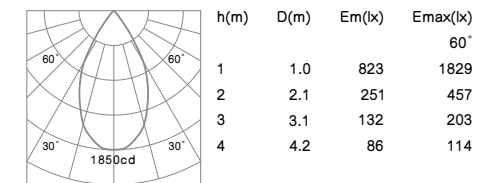
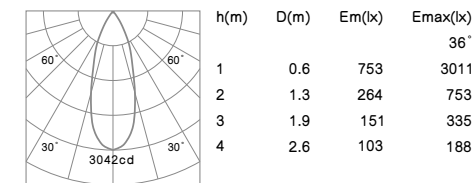
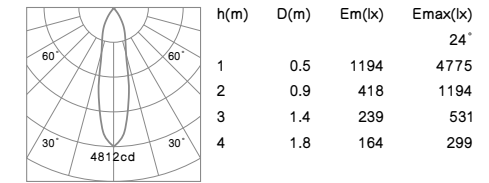
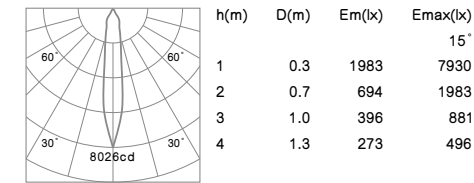

# FUTW Invisible



**COB LED CRI≥80 IP20 CE RoHS**  
 Mounting frame color: White Silver Black  
 Color temperature: 2700K 3000K 4000K  
 Beam angle: 15° 24° 36° 60°

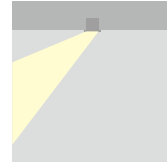

Driver gear for LED:  
 Non-Dimmable  
 1-10V Dimmable  
 DALI Dimmable  
 Triac Dimmable

- Housing and bracket: Cast aluminum + steel sheet.
- Spotlight adjustable 358° rotating around the vertical axis and 75° rotating around the horizontal axis.
- Anti-dazzle ring: Plastic black.
- Light spot pipe is available, which could make the light more soft and more perfect.
- Light source: COB LED with a high efficiency reflector of optical.
- The light can be compatible with emergency battery.
- Mounting fixed kit: Cast aluminum, for flush-mounting installation in plasterboard ceilings.

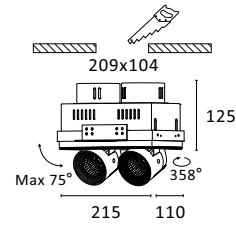

COB LED

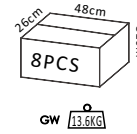

## R6361 2x10W 2100lm

With 2 pieces of LED Driver 36V-250mA  
 230V-50Hz

NW  
 1.50kg

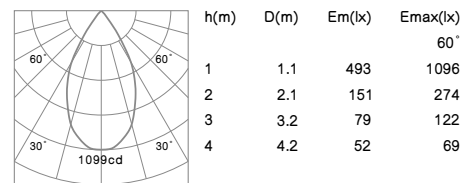
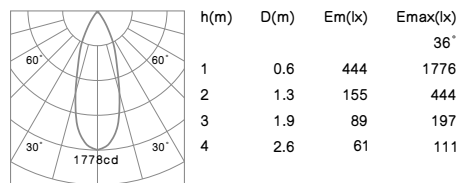
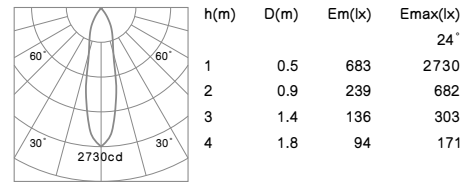
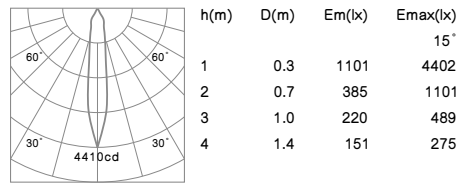

# FUTW Invisible

## R6361 2x15W 2740lm

With 2 pieces of LED Driver 36V-350mA  
 230V-50Hz

NW  
 1.50kg

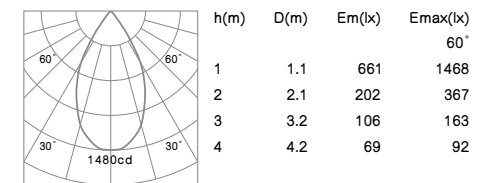
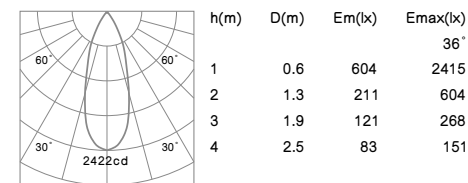
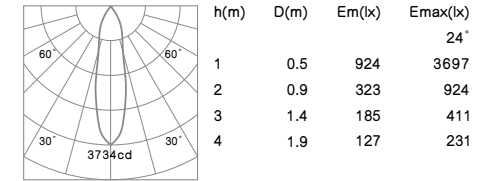
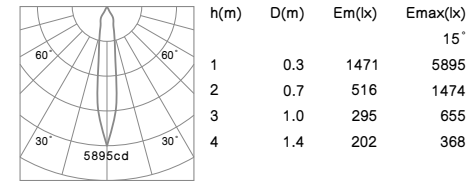

## R6361 2x20W 3700lm

With 2 pieces of LED Driver 36V-500mA  
 230V-50Hz

NW  
 1.50kg

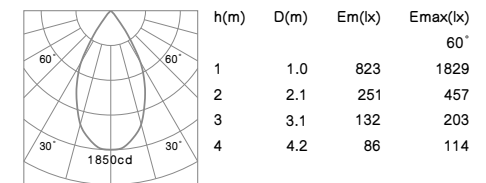
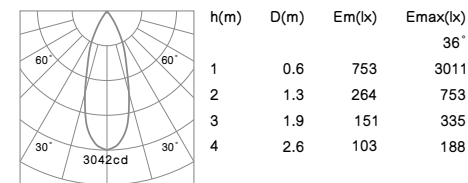
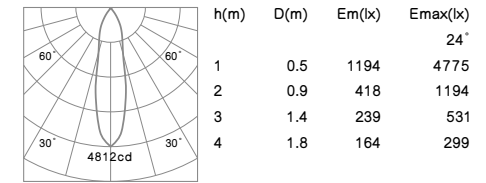
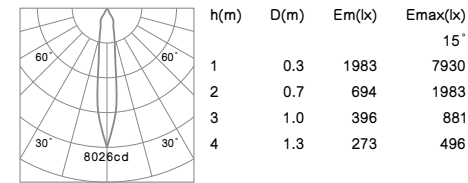

**FUTW Invisible**



**COB LED CRI≥80 IP20 CE RoHS**  
 Mounting frame color: White Silver Black  
 Color temperature: 2700K 3000K 4000K  
 Beam angle: 15° 24° 36° 60°

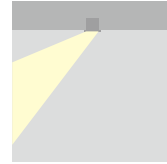

Driver gear for LED:  
 Non-Dimmable  
 1-10V Dimmable  
 DALI Dimmable  
 Triac Dimmable

- Housing and bracket: Cast aluminum + steel sheet.
- Spotlight adjustable 358° rotating around the vertical axis and 75° rotating around the horizontal axis.
- Anti-dazzle ring: Plastic black.
- Light spot pipe is available, which could make the light more soft and more perfect.
- Light source: COB LED with a high efficiency reflector of optical.
- The light can be compatible with emergency battery.
- Mounting fixed kit: Cast aluminum, for flush-mounting installation in plasterboard ceilings.

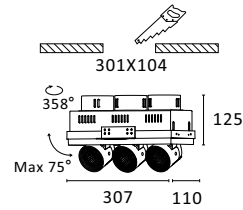

COB LED

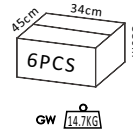

**R6362 3x10W 3150lm**  
 With 3 pieces of LED Driver 36V-250mA  
 230V-50Hz

NW  
 2.19kg

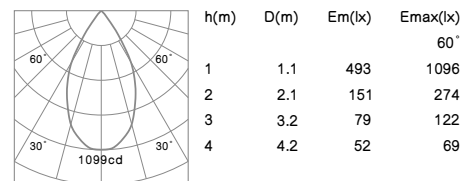
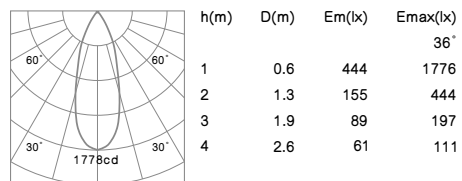
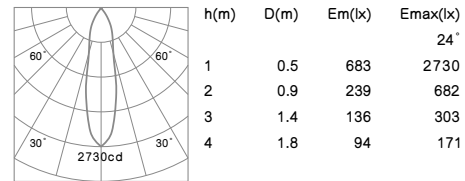
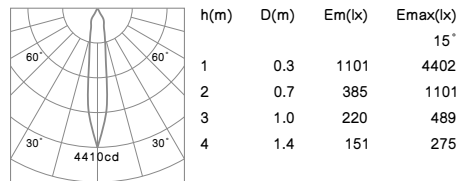

**FUTW Invisible**

**R6362 3x15W 4110lm**  
 With 3 pieces of LED Driver 36V-350mA  
 230V-50Hz

NW  
 2.19kg

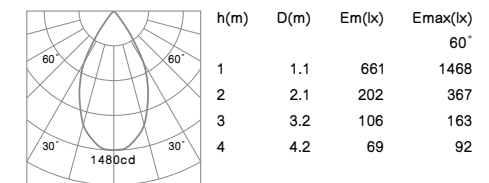
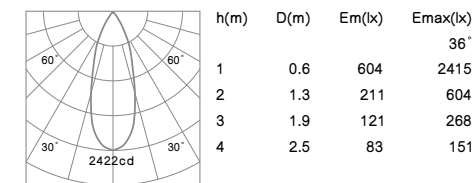
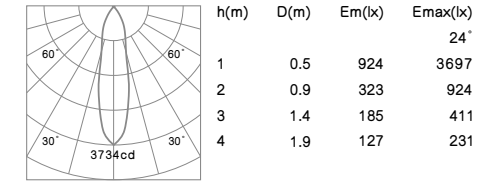
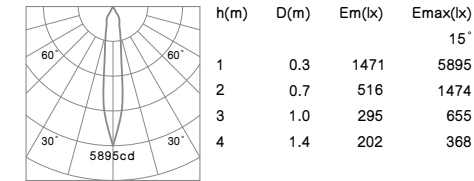

**R6362 3x20W 5550lm**  
 With 3 pieces of LED Driver 36V-500mA  
 230V-50Hz

NW  
 2.19kg

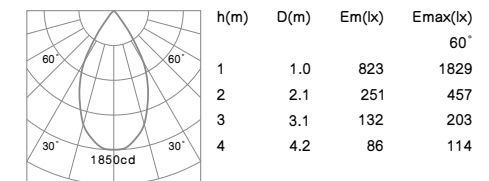
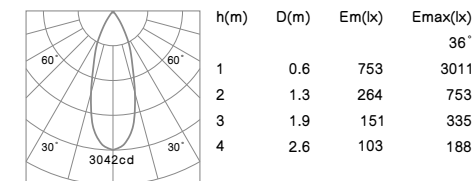
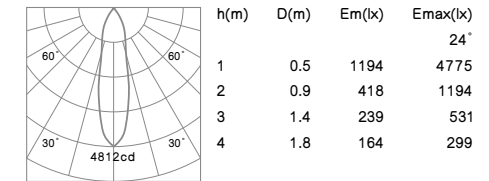
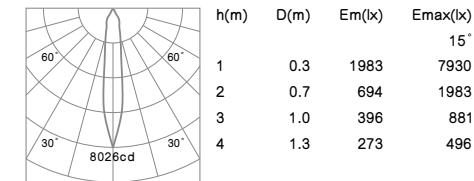

# FUTW Visible



**COB LED** **CRi>80** **IP20** **CE** **RoHS**  
 Mounting frame color: White Silver Black  
 Color temperature: 2700K 3000K 4000K  
 Beam angle: 15° 24° 36° 60°

Driver gear for LED:  
 Non-Dimmable  
 1-10V Dimmable  
 DALI Dimmable  
 Triac Dimmable

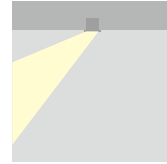

- Housing and bracket: Cast aluminum + steel sheet.
- Spotlight adjustable 358° rotating around the vertical axis and 75° rotating around the horizontal axis.
- Mounting ring: Pure aluminum.
- Anti-dazzle ring: Plastic black.
- Light spot pipe is available, which could make the light more soft and more perfect.
- Light source: COB LED with a high efficiency reflector of optical.
- The light can be compatible with emergency battery.

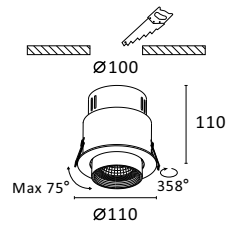

COB LED

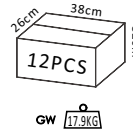

## R6295 10W 1050lm With LED Driver 36V-250mA 230V-50Hz

NW  
0.64kg

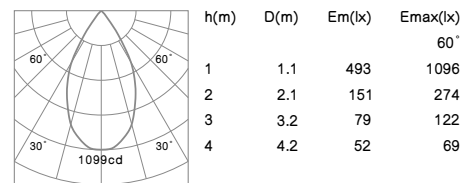
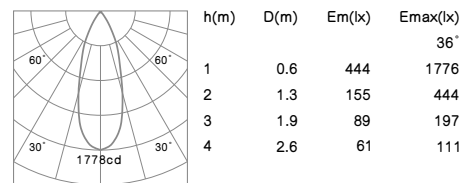
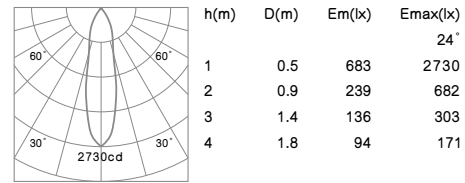
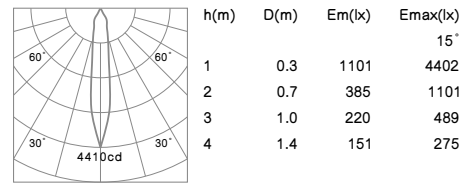

# FUTW Visible

## R6295 15W 1370lm With LED Driver 36V-350mA 230V-50Hz

NW  
0.64kg

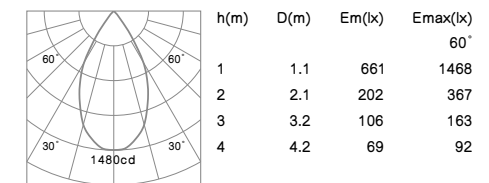
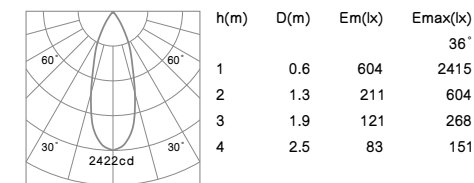
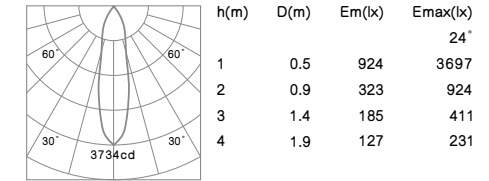
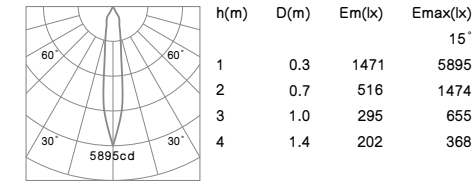

## R6295 20W 1850lm With LED Driver 36V-500mA 230V-50Hz

NW  
0.64kg

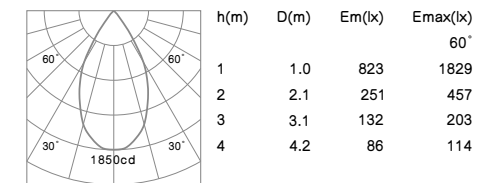
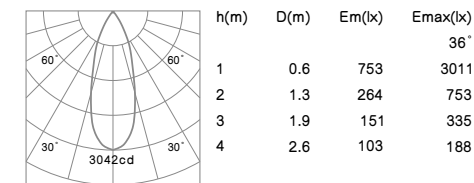
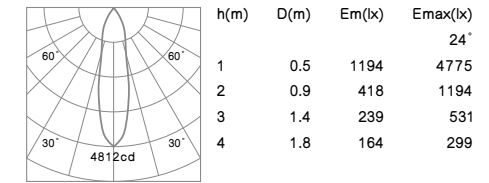
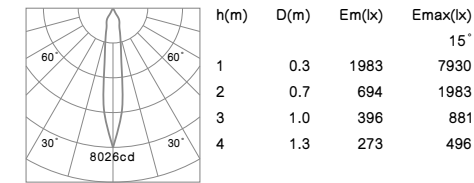



# FUTW Visible



**COB LED CRI≥80 IP20 CE RoHS**  
 Mounting frame color: White Silver Black  
 Color temperature: 2700K 3000K 4000K  
 Beam angle: 15° 24° 36° 60°

Driver gear for LED:  
 Non-Dimmable  
 1-10V Dimmable  
 DALI Dimmable  
 Triac Dimmable

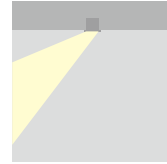

- Housing and bracket: Cast aluminum + steel sheet.
- Spotlight adjustable 358° rotating around the vertical axis and 75° rotating around the horizontal axis.
- Mounting ring: Pure aluminum.
- Anti-dazzle ring: Plastic black.
- Light spot pipe is available, which could make the light more soft and more perfect.
- Light source: COB LED with a high efficiency reflector of optical.
- The light can be compatible with emergency battery.

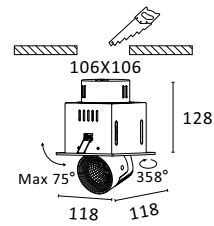

COB LED

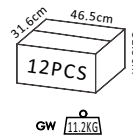

## R6363 10W 1050lm With LED Driver 36V-250mA 230V-50Hz

NW  
0.79kg

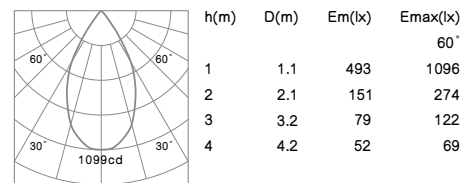
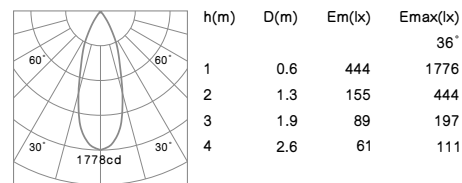
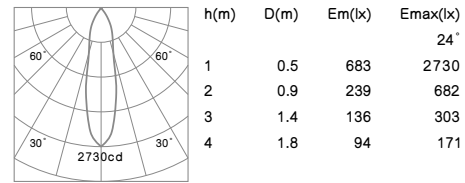
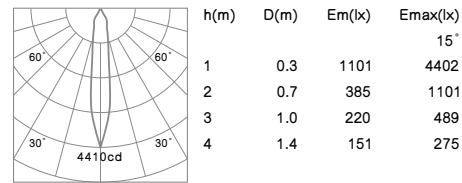

# FUTW Visible

## R6363 15W 1370lm With LED Driver 36V-350mA 230V-50Hz

NW  
0.79kg

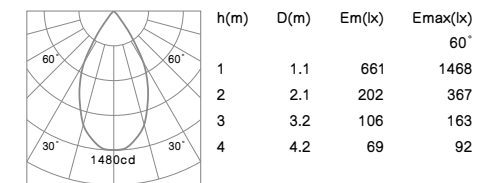
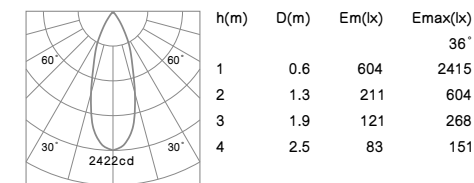
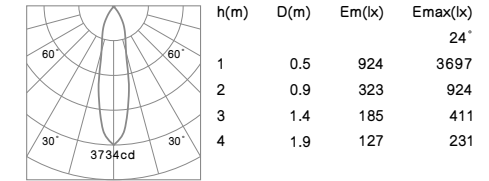
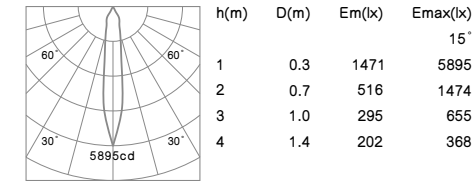

## R6363 20W 1850lm With LED Driver 36V-500mA 230V-50Hz

NW  
0.79kg

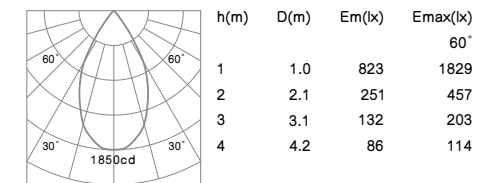
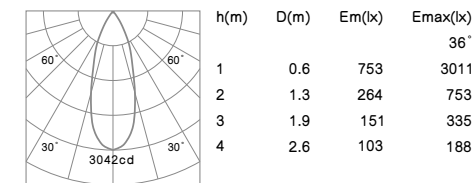
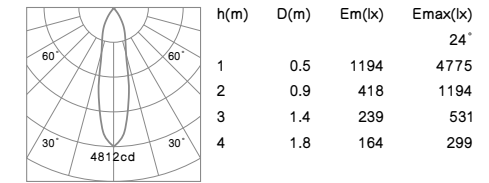
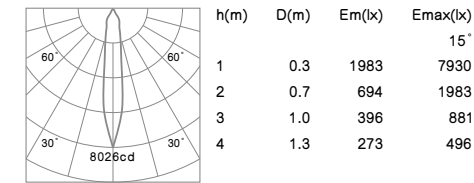

# FUTW Visible



**COB LED CRI≥80 IP20 CE RoHS**  
 Mounting frame color: White Silver Black  
 Color temperature: 2700K 3000K 4000K  
 Beam angle: 15° 24° 36° 60°

Driver gear for LED:  
 Non-Dimmable  
 1-10V Dimmable  
 DALI Dimmable  
 Triac Dimmable

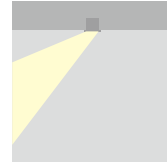

- Housing and bracket: Cast aluminum + steel sheet.
- Spotlight adjustable 358° rotating around the vertical axis and 75° rotating around the horizontal axis.
- Mounting ring: Pure aluminum.
- Anti-dazzle ring: Plastic black.
- Light spot pipe is available, which could make the light more soft and more perfect.
- Light source: COB LED with a high efficiency reflector of optical.
- The light can be compatible with emergency battery.

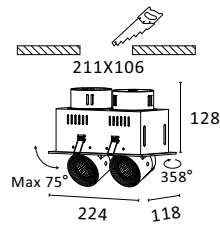

COB LED

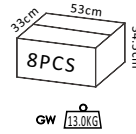

## R6364 2x10W 2100lm

With 2 pieces of LED Driver 36V-250mA  
 230V-50Hz

NW  
 1.42kg

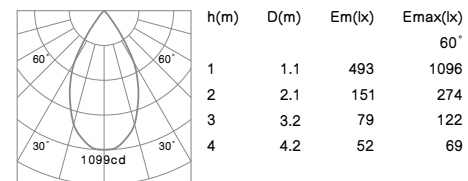
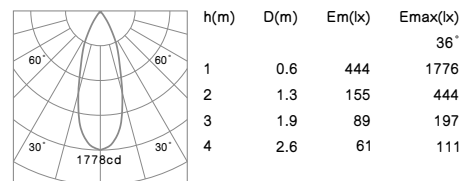
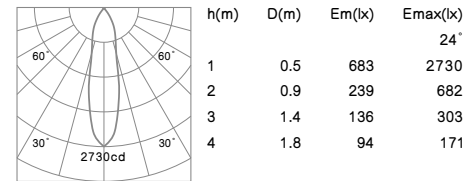
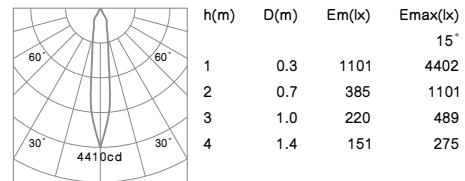

# FUTW Visible

## R6364 2x15W 2740lm

With 2 pieces of LED Driver 36V-350mA  
 230V-50Hz

NW  
 1.42kg

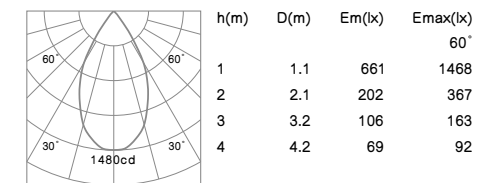
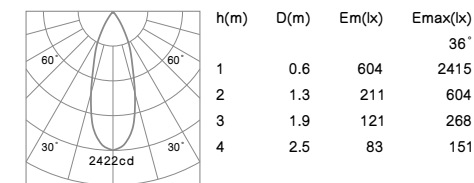
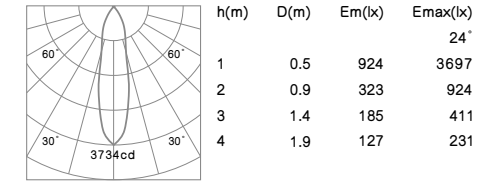
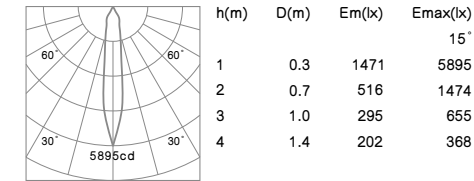

## R6364 2x20W 3700lm

With 2 pieces of LED Driver 36V-500mA  
 230V-50Hz

NW  
 1.42kg

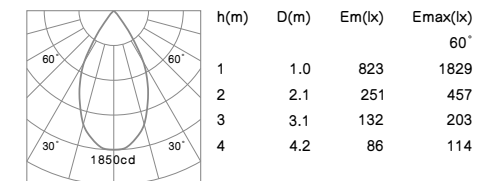
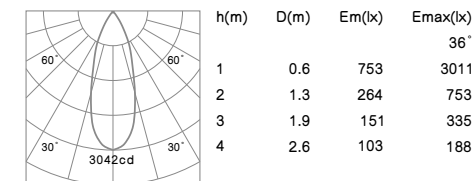
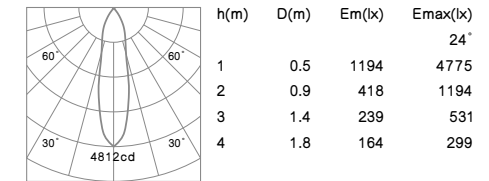
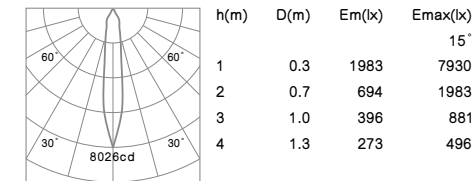

**FUTW** Visible



**COB LED CRI≥80 IP20 CE RoHS**  
 Mounting frame color: White Silver Black  
 Color temperature: 2700K 3000K 4000K  
 Beam angle: 15° 24° 36° 60°

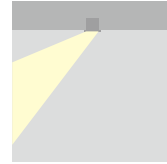

Driver gear for LED:  
 Non-Dimmable  
 1-10V Dimmable  
 DALI Dimmable  
 Triac Dimmable

- Housing and bracket: Cast aluminum + steel sheet.
- Spotlight adjustable 358° rotating around the vertical axis and 75° rotating around the horizontal axis.
- Mounting ring: Pure aluminum.
- Anti-dazzle ring: Plastic black.
- Light spot pipe is available, which could make the light more soft and more perfect.
- Light source: COB LED with a high efficiency reflector of optical.
- The light can be compatible with emergency battery.

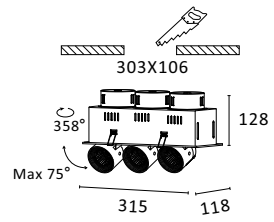

COB LED

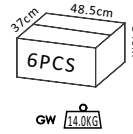

**R6365 3x10W 3150lm**  
 With 3 pieces of LED Driver 36V-250mA  
 230V-50Hz

NW  
 2.05kg

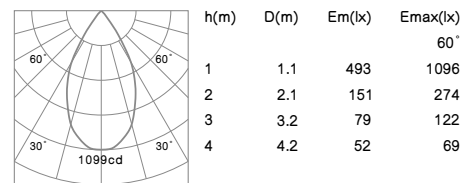
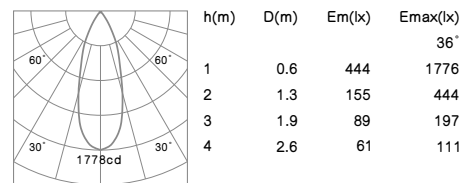
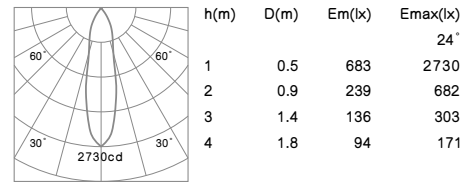
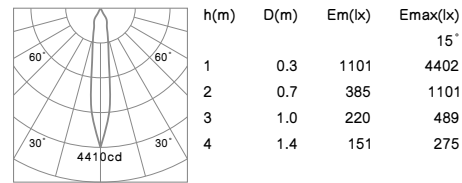

**FUTW** Visible

**R6365 3x15W 4110lm**  
 With 3 pieces of LED Driver 36V-350mA  
 230V-50Hz

NW  
 2.05kg

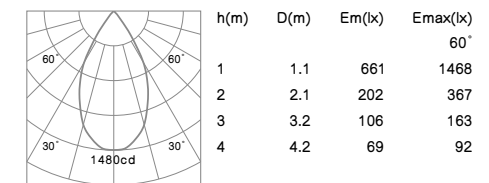
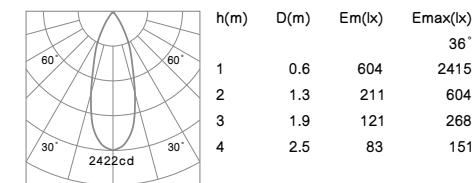
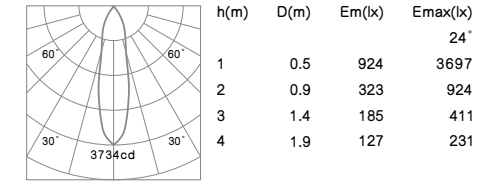
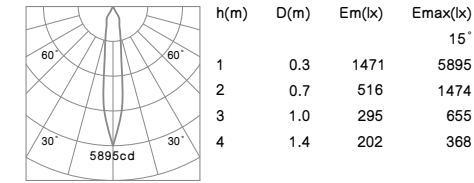

**R6365 3x20W 5550lm**  
 With 3 pieces of LED Driver 36V-500mA  
 230V-50Hz

NW  
 2.05kg

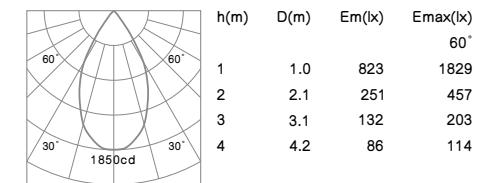
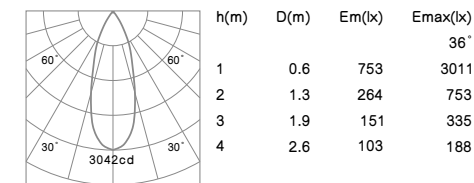
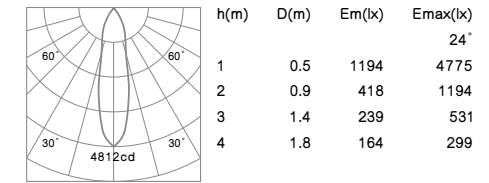
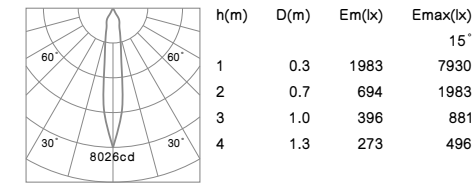

**FUTW** Surface-mounted



**COB LED CRI≥80 IP20 CE RoHS**

Housing color: White Silver Black  
 Color temperature: 2700K 3000K 4000K  
 Beam angle: 15° 24° 36° 60°

Driver gear for LED:  
 Non-Dimmable  
 1-10V Dimmable  
 DALI Dimmable  
 Triac Dimmable

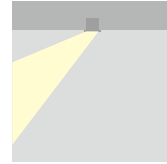

- Housing and bracket: Cast aluminum + steel sheet.
- Spotlight adjustable 358° rotating around the vertical axis and 75° rotating around the horizontal axis.
- Mounting ring: Pure aluminum.
- Anti-dazzle ring: Plastic black.
- Light spot pipe is available, which could make the light more soft and more perfect.
- Light source: COB LED with a high efficiency reflector of optical.

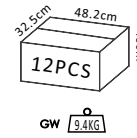
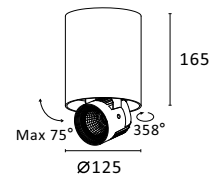

**C6047 10W 1050lm**  
 With LED Driver 36V-250mA  
 230V-50Hz

NW  
 1.33kg

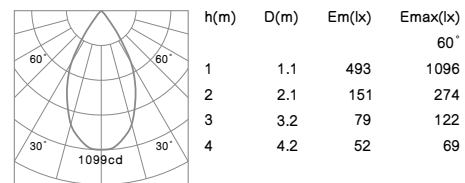
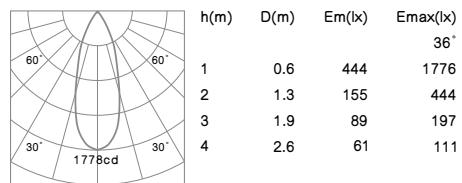
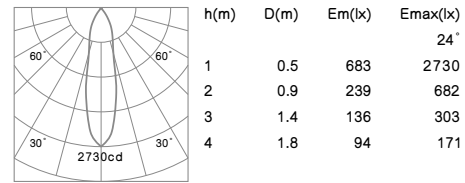
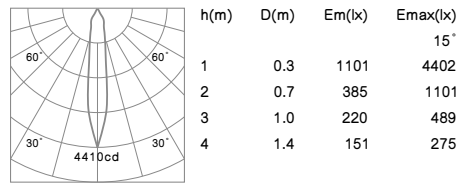

**FUTW** Surface-mounted

**C6047 15W 1370lm**  
 With LED Driver 36V-350mA  
 230V-50Hz

NW  
 1.33kg

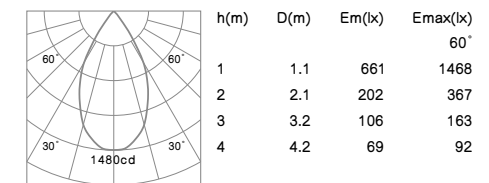
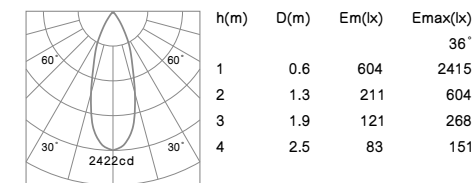
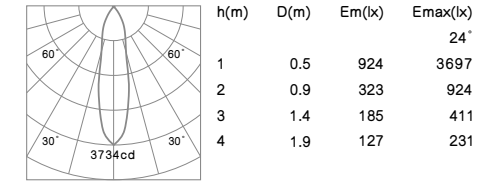
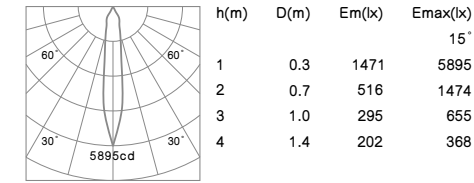

**C6047 20W 1850lm**  
 With LED Driver 36V-500mA  
 230V-50Hz

NW  
 1.33kg

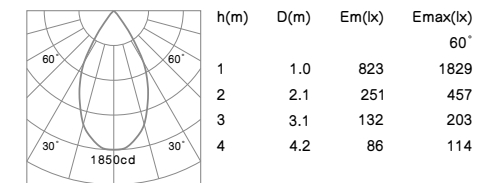
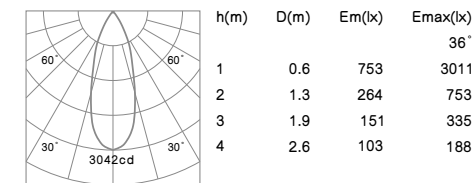
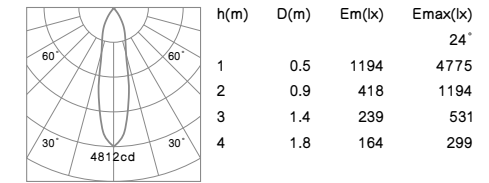
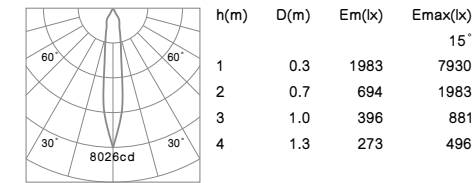



**FUTW** Surface-mounted



**COB LED CRI≥80 IP20 CE RoHS**

Housing color: White Silver Black  
 Color temperature: 2700K 3000K 4000K  
 Beam angle: 15° 24° 36° 60°

Driver gear for LED: Non-Dimmable  
 1-10V Dimmable  
 DALI Dimmable  
 Triac Dimmable

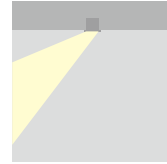

- Housing and bracket: Cast aluminum + steel sheet.
- Spotlight adjustable 358° rotating around the vertical axis and 75° rotating around the horizontal axis.
- Mounting ring: Pure aluminum.
- Anti-dazzle ring: Plastic black.
- Light spot pipe is available, which could make the light more soft and more perfect.
- Light source: COB LED with a high efficiency reflector of optical.

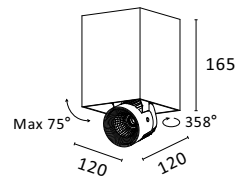

COB LED

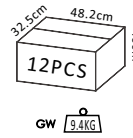

**C6048 10W 1050lm**  
 With LED Driver 36V-250mA  
 230V-50Hz

NW  
 1.39kg

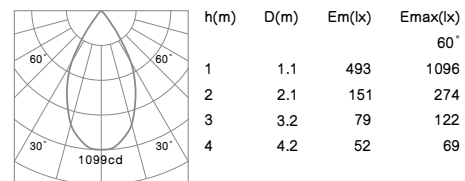
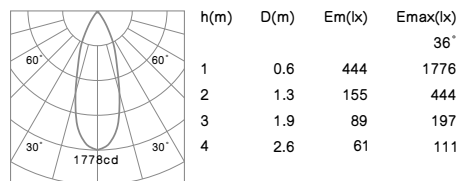
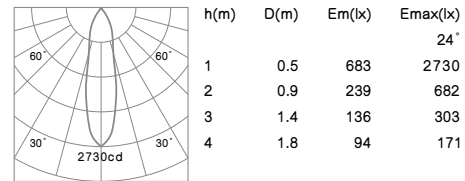
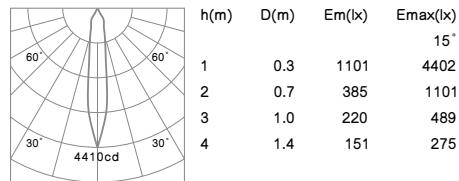

**FUTW** Surface-mounted

**C6048 15W 1370lm**  
 With LED Driver 36V-350mA  
 230V-50Hz

NW  
 1.39kg

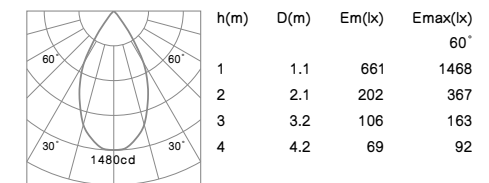
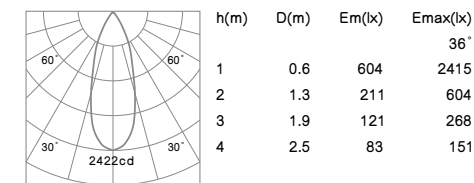
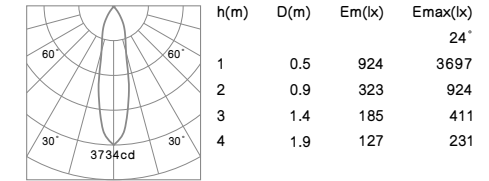
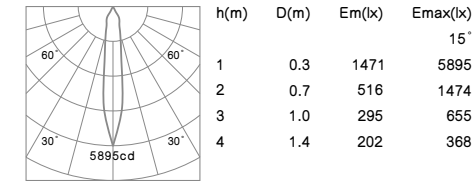

**C6048 20W 1850lm**  
 With LED Driver 36V-500mA  
 230V-50Hz

NW  
 1.39kg

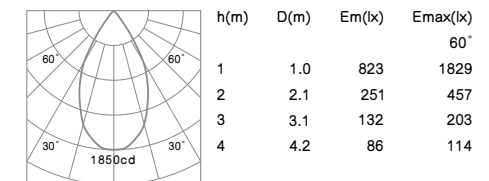
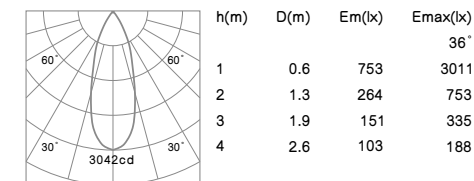
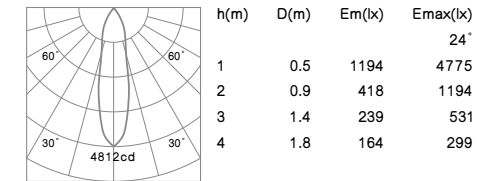
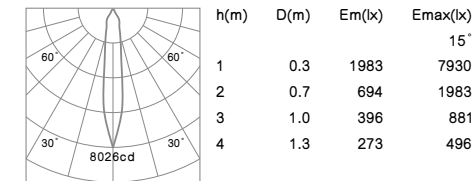

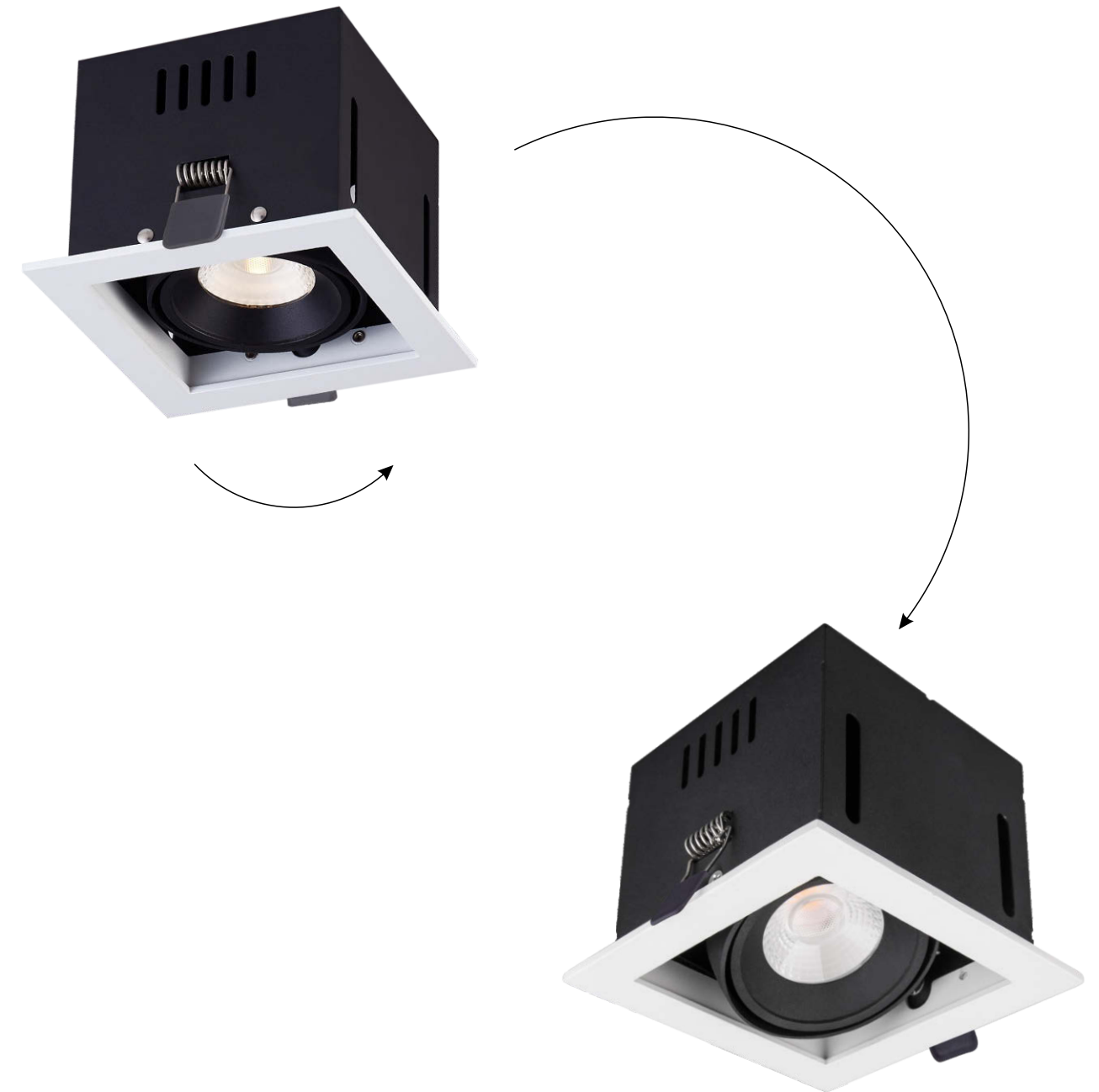

**Spot light source holder rings:**

Cast aluminum, they are positioned on adjustable gimbals and equipped with mechanical locking devices which allow an inclination of each light source by  $\pm 45^\circ$  in relation to the horizontal and vertical axis.



BOX



317

BOX



318



# BOX

## Visible



S □ 118x118mm 6W 10W 15W P321



SD □ 118x224mm 2x6W 2x10W 2x15W P323



ST □ 118x315mm 3x6W 3x10W 3x15W P325

## Invisible

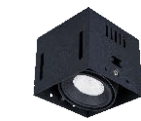

S □ 110x110mm 6W 10W 15W P327



SD □ 110x215mm 2x6W 2x10W 2x15W P329



ST □ 110x307mm 3x6W 3x10W 3x15W P331

# BOX

## Visible



L □ 191x191mm 15W 20W 25W P333



LD □ 191x356mm 2x15W 2x20W 2x25W P335



LT □ 191x509mm 3x15W 3x20W 3x25W P337

## Invisible



L □ 170x170mm 15W 20W 25W P339



LD □ 170x336mm 2x15W 2x20W 2x25W P341



LT □ 170x488mm 3x15W 3x20W 3x25W P343





**COB LED** **CRi≥80** **IP20** **CE** **RoHS**

Mounting frame color: White Silver Black  
 Color temperature: 2700K 3000K 4000K  
 Beam angle: 24° 36° 60°

Driver gear for LED:  
 Non-Dimmable  
 1-10V Dimmable  
 DALI Dimmable  
 Triac Dimmable

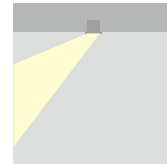

- The lamp housing is made of steel sheet.
- Mounting frame: Cast aluminum.
- Spot light source holder rings: Cast aluminum, they are positioned on adjustable gimbals and equipped with mechanical locking devices which allow an inclination of each light source by ±45° in relation to the horizontal and vertical axis.
- Light source: COB LED with a lens of optical.
- The light can be compatible with emergency battery.

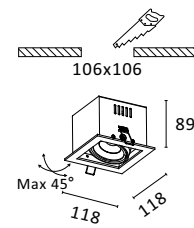

COB LED

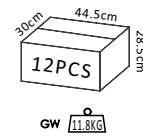

**R6212 6W 700lm**  
 With LED Driver 36V-135mA  
 230V-50Hz

NW  
 0,74kg

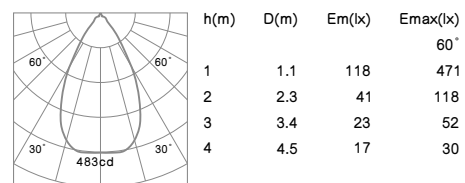
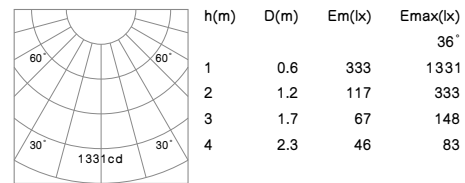
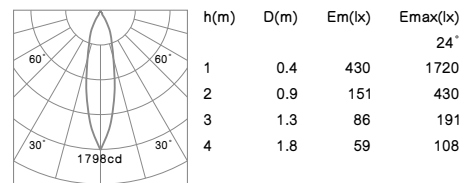

**R6158 10W 1190lm**  
 With LED Driver 36V-250mA  
 230V-50Hz

NW  
 0,74kg

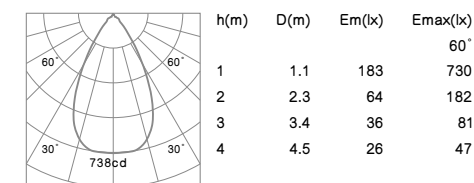
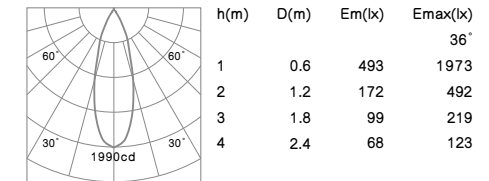
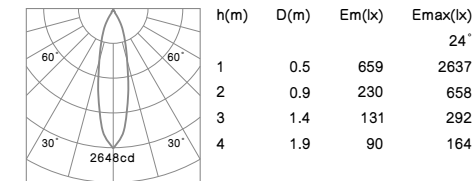

**R6356 15W 1540lm**  
 With LED Driver 36V-350mA  
 230V-50Hz

NW  
 0,74kg

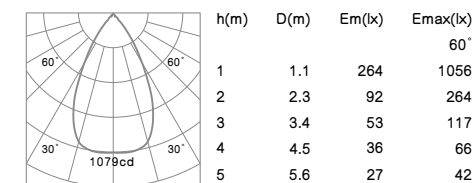
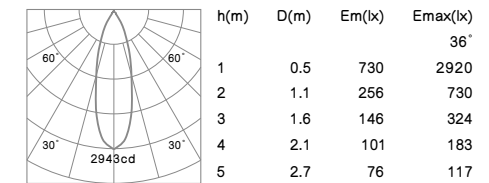
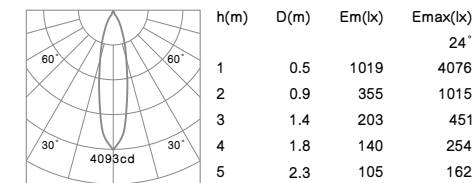



**COB LED** **CRi≥80** **IP20** **CE** **RoHS**

Mounting frame color: White Silver Black  
 Color temperature: 2700K 3000K 4000K  
 Beam angle: 24° 36° 60°

Driver gear for LED: Non-Dimmable  
 1-10V Dimmable  
 DALI Dimmable  
 Triac Dimmable

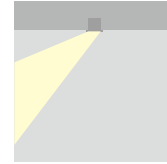

- The lamp housing is made of steel sheet.
- Mounting frame: Cast aluminum.
- Spot light source holder rings: Cast aluminum, they are positioned on adjustable gimbals and equipped with mechanical locking devices which allow an inclination of each light source by ±45° in relation to the horizontal and vertical axis.
- Light source: COB LED with a lens of optical.
- The light can be compatible with emergency battery.

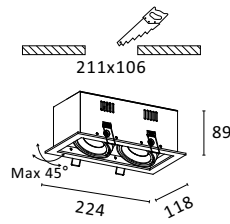

COB LED

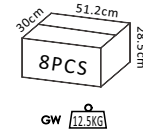

**R6213 2x6W 1400lm**  
 With 2 pieces of LED Driver 36V-135mA  
 230V-50Hz

NW  
 1.33kg

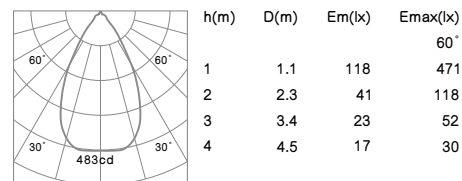
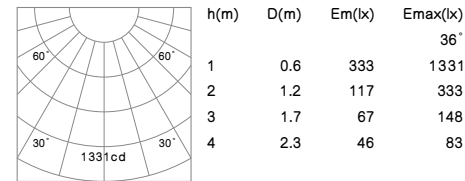
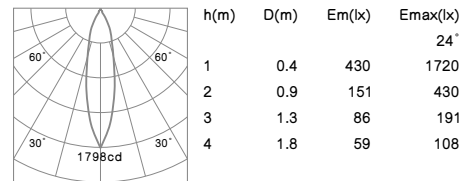

**R6159 2x10W 2380lm**  
 With 2 pieces of LED Driver 36V-250mA  
 230V-50Hz

NW  
 1.33kg

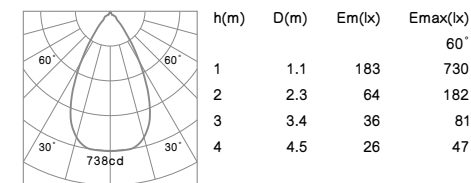
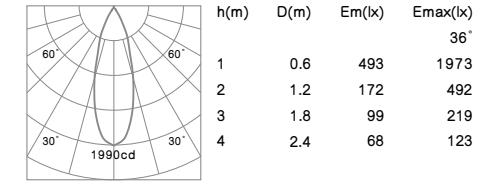
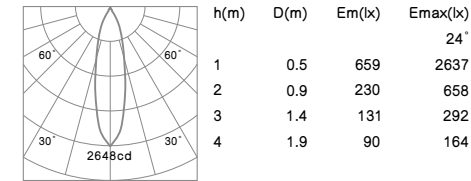

**R6357 2x15W 3080lm**  
 With 2 pieces of LED Driver 36V-350mA  
 230V-50Hz

NW  
 1.33kg

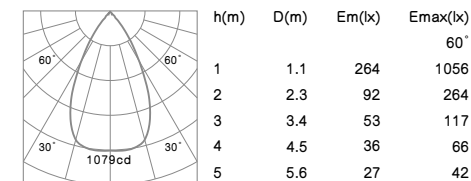
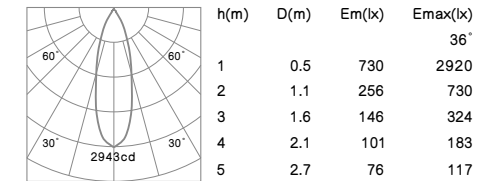
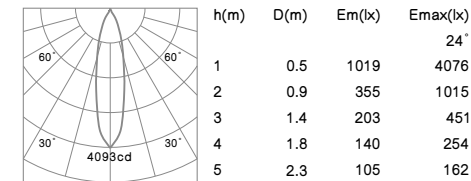



**COB LED** **CRi≥80** **IP20** **CE** **RoHS**

Mounting frame color: White Silver Black  
 Color temperature: 2700K 3000K 4000K  
 Beam angle: 24° 36° 60°

Driver gear for LED: Non-Dimmable  
 1-10V Dimmable  
 DALI Dimmable  
 Triac Dimmable

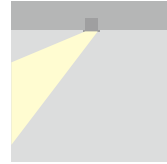

- The lamp housing is made of steel sheet.
- Mounting frame: Cast aluminum.
- Spot light source holder rings: Cast aluminum, they are positioned on adjustable gimbals and equipped with mechanical locking devices which allow an inclination of each light source by ±45° in relation to the horizontal and vertical axis.
- Light source: COB LED with a lens of optical.
- The light can be compatible with emergency battery.

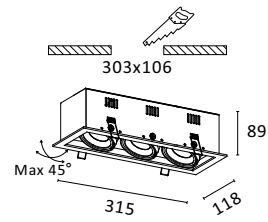

COB LED

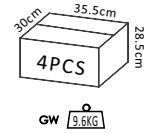

**R6214 3x6W 2100lm**  
 With 3 pieces of LED Driver 36V-135mA  
 230V-50Hz

NW  
 1.79kg

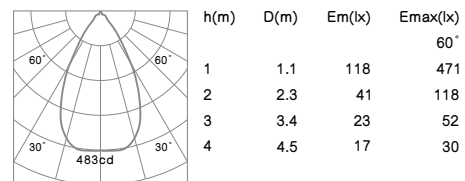
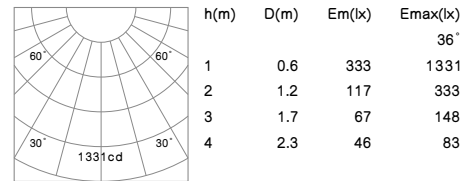
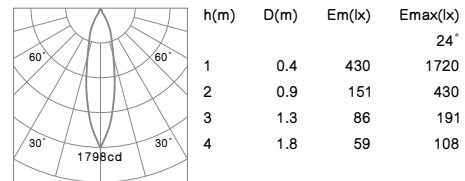

**R6160 3x10W 3520lm**  
 With 3 pieces of LED Driver 36V-250mA  
 230V-50Hz

NW  
 1.79kg

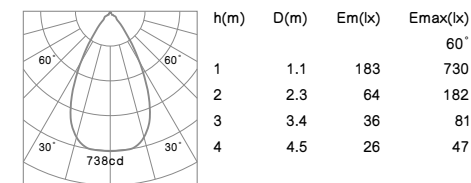
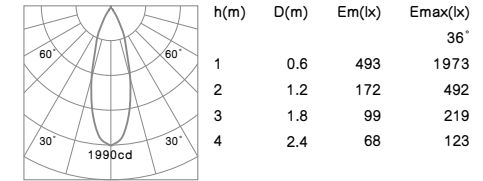
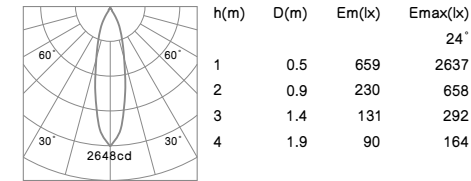

**R6358 3x15W 4620lm**  
 With 3 pieces of LED Driver 36V-350mA  
 230V-50Hz

NW  
 2.00kg

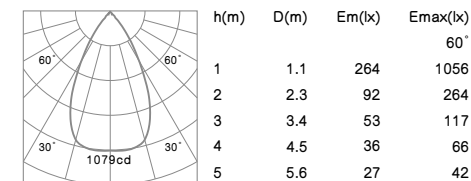
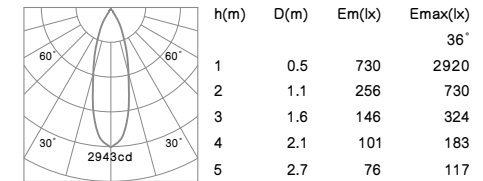
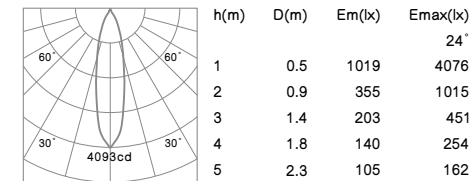



**COB LED** **CRi≥80** **IP20** **CE** **RoHS**

Mounting frame color: White Silver Black  
 Color temperature: 2700K 3000K 4000K  
 Beam angle: 24° 36° 60°

Driver gear for LED: Non-Dimmable  
 1-10V Dimmable  
 DALI Dimmable  
 Triac Dimmable

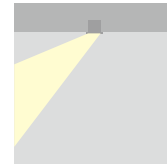

- This fixture has one outer metal bezel and a lamp housing that is made of steel sheet.
- Mounting fixed kit: Cast aluminum, for flush-mounting installation in plasterboard ceilings.
- Spot light source holder rings: Cast aluminum, they are positioned on adjustable gimbals and equipped with mechanical locking devices which allow an inclination of each light source by ±45° in relation to the horizontal and vertical axis.
- Light source: COB LED with a lens of optical.
- The light can be compatible with emergency battery.

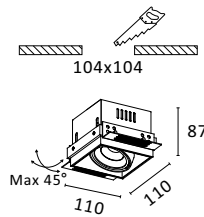

COB LED

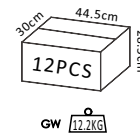

**R6209 6W 700lm**  
 With LED Driver 36V-135mA  
 230V-50Hz

NW  
 0.81kg

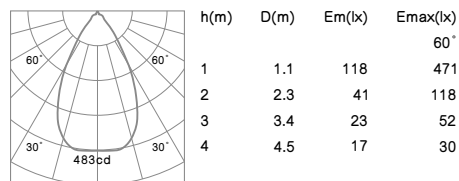
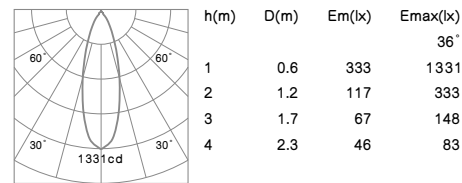
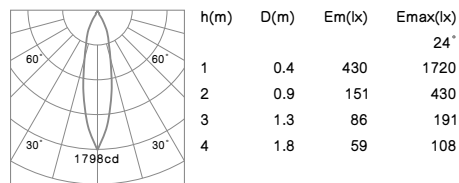

**R6155 10W 1190lm**  
 With LED Driver 36V-250mA  
 230V-50Hz

NW  
 0.81kg

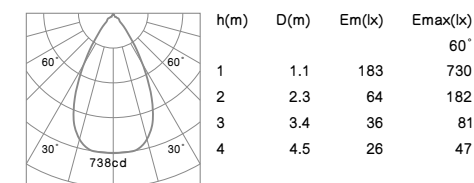
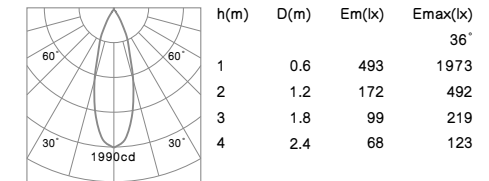
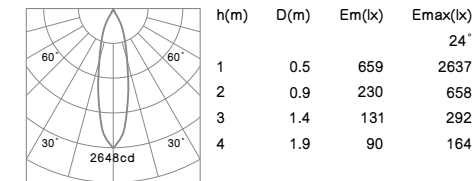

**R6238 15W 1540lm**  
 With LED Driver 36V-350mA  
 230V-50Hz

NW  
 0.81kg

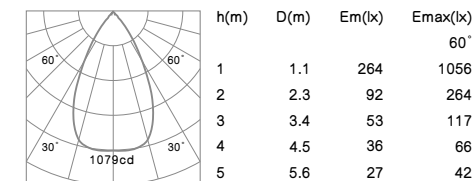
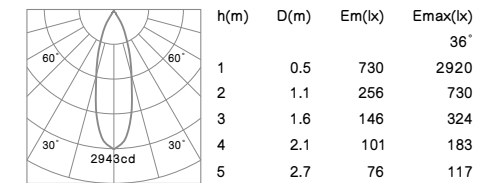
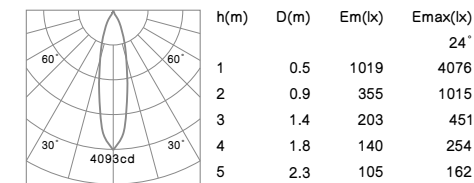



**BOX Invisible SD**



**COB LED CRI≥80 IP20 CE RoHS**

Mounting frame color: White Silver Black  
 Color temperature: 2700K 3000K 4000K  
 Beam angle: 24° 36° 60°

Driver gear for LED: Non-Dimmable  
 1-10V Dimmable  
 DALI Dimmable  
 Triac Dimmable

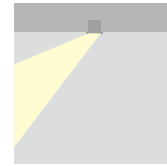

- This fixture has one outer metal bezel and a lamp housing that is made of steel sheet.
- Mounting fixed kit: Cast aluminum, for flush-mounting installation in plasterboard ceilings.
- Spot light source holder rings: Cast aluminum, they are positioned on adjustable gimbals and equipped with mechanical locking devices which allow an inclination of each light source by ±45° in relation to the horizontal and vertical axis.
- Light source: COB LED with a lens of optical.
- The light can be compatible with emergency battery.

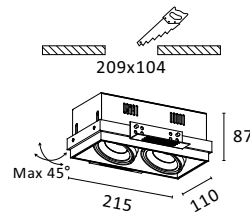

COB LED

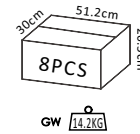

**R6210 2x6W 1400lm**  
 With 2 pieces of LED Driver 36V-135mA  
 230V-50Hz

NW  
 1.52kg

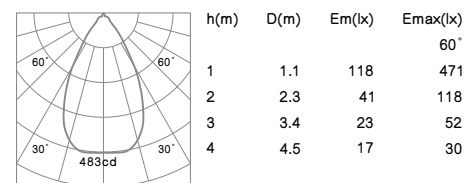
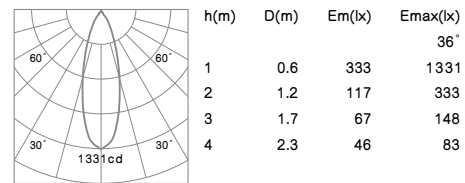
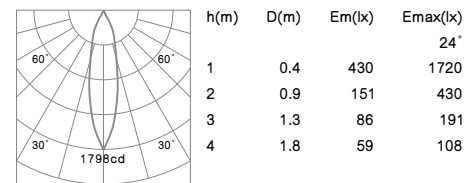

**BOX Invisible SD**

**R6156 2x10W 2380lm**  
 With 2 pieces of LED Driver 36V-250mA  
 230V-50Hz

NW  
 1.52kg

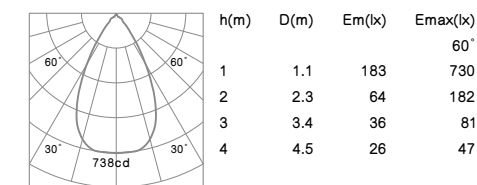
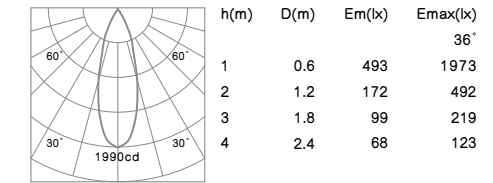
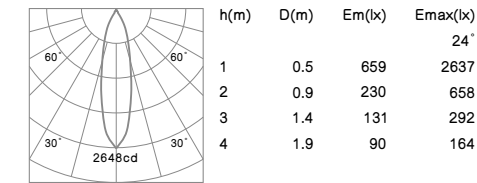

**R6239 2x15W 3080lm**  
 With 2 pieces of LED Driver 36V-350mA  
 230V-50Hz

NW  
 1.52kg

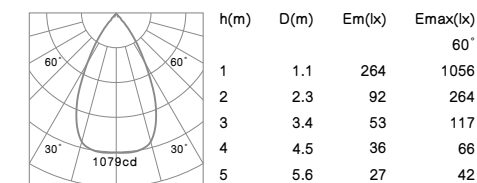
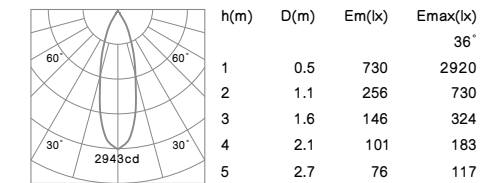
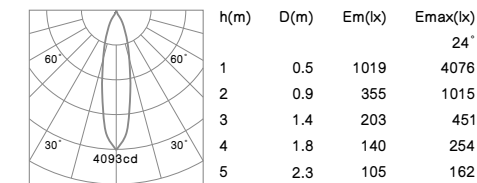

**BOX Invisible ST**



**COB LED CRI≥80 IP20 CE RoHS**

Mounting frame color: White Silver Black  
 Color temperature: 2700K 3000K 4000K  
 Beam angle: 24° 36° 60°

Driver gear for LED: Non-Dimmable  
 1-10V Dimmable  
 DALI Dimmable  
 Triac Dimmable

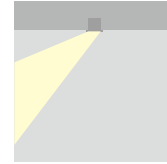

- This fixture has one outer metal bezel and a lamp housing that is made of steel sheet.
- Mounting fixed kit: Cast aluminum, for flush-mounting installation in plasterboard ceilings.
- Spot light source holder rings: Cast aluminum, they are positioned on adjustable gimbals and equipped with mechanical locking devices which allow an inclination of each light source by ±45° in relation to the horizontal and vertical axis.
- Light source: COB LED with a lens of optical.
- The light can be compatible with emergency battery.

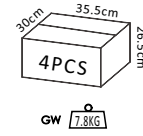
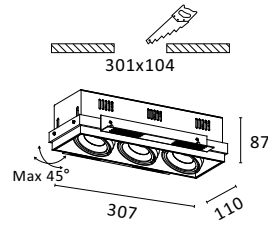

**R6211 3x6W 2100lm**  
 With 3 pieces of LED Driver 36V-135mA  
 230V-50Hz

NW  
 2.32kg

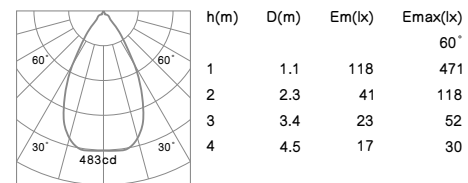
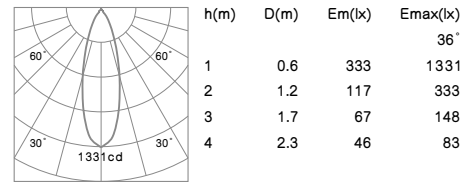
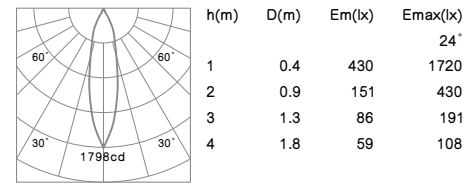

**BOX Invisible ST**

**R6157 3x10W 3570lm**  
 With 3 pieces of LED Driver 36V-250mA  
 230V-50Hz

NW  
 2.32kg

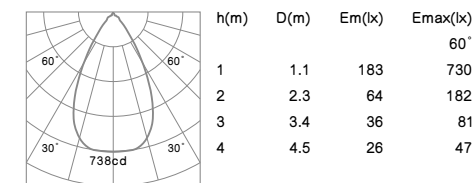
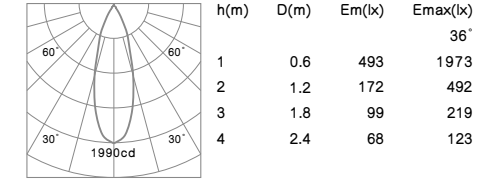
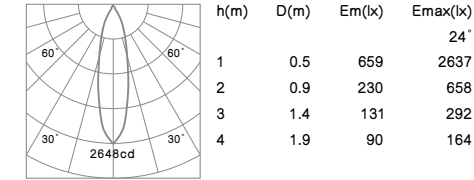

**R6240 3x15W 4620lm**  
 With 3 pieces of LED Driver 36V-350mA  
 230V-50Hz

NW  
 2.32kg

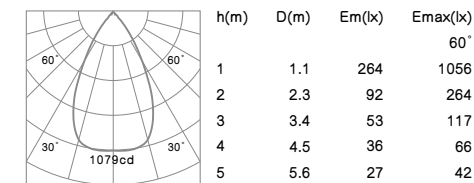
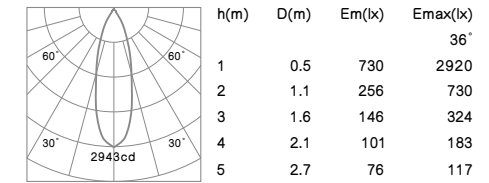
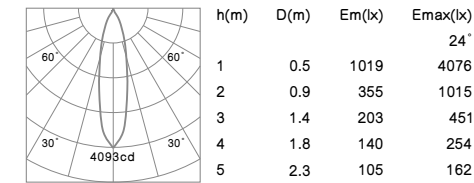

**BOX** Visible L



**LED QR111** CRI≥80 IP20 CE RoHS  
 Mounting frame color: White Silver Black  
 Color temperature: 2700K 3000K 4000K  
 Beam angle: 15° 24° 36°

Driver gear for LED:  
 Non-Dimmable  
 1-10V Dimmable  
 DALI Dimmable  
 Triac Dimmable

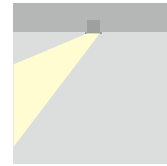

- The lamp housing is made of steel sheet.
- Mounting frame: Cast aluminum.
- Spot light source holder rings: Cast aluminum, they are positioned on adjustable gimbals and equipped with mechanical locking devices which allow an inclination of each light source by ±45° in relation to the horizontal and vertical axis.
- Light source: COB LED with a lens of optical.
- The light can be compatible with emergency battery.

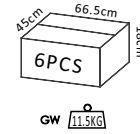
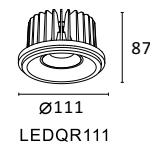
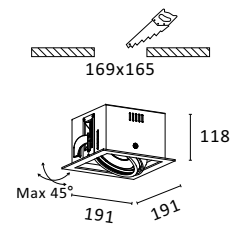

**R6206 15W 1700lm**  
 With LED Driver 36V-350mA  
 230V-50Hz

NW  
 1.58kg

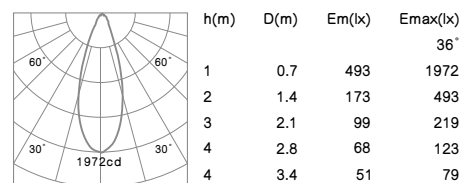
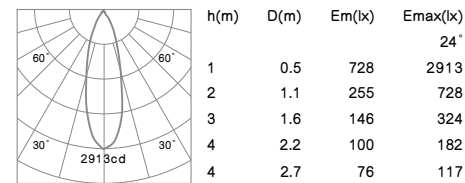
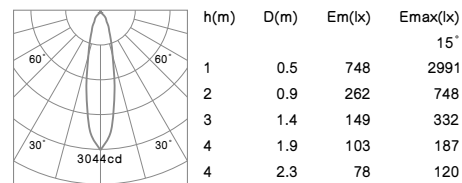

**BOX** Visible L

**R6178 20W 2320lm**  
 With LED Driver 36V-500mA  
 230V-50Hz

NW  
 1.58kg

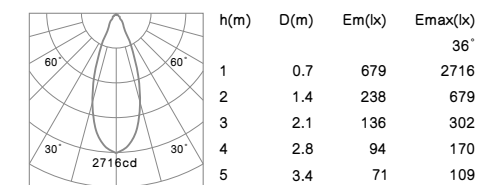
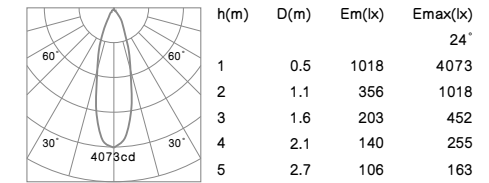
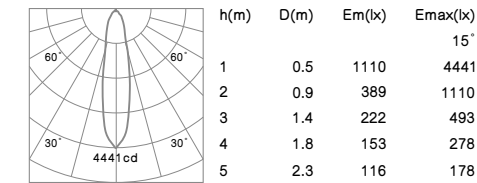

**R6191 25W 2750lm**  
 With LED Driver 36V-600mA  
 230V-50Hz

NW  
 1.58kg

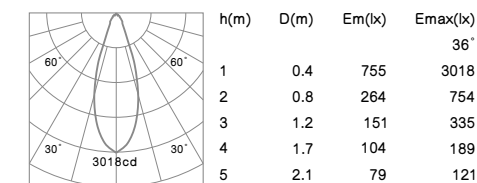
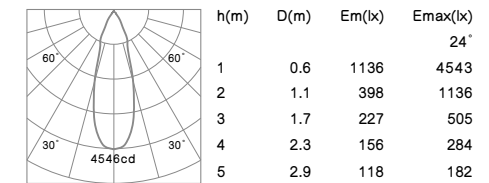
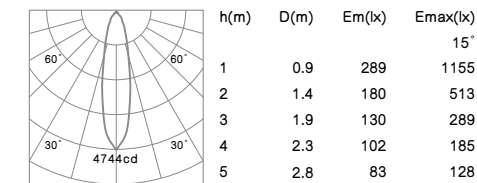



**LED QR111 CRI≥80 IP20 CE RoHS**

Mounting frame color: White Silver Black  
 Color temperature: 2700K 3000K 4000K  
 Beam angle: 15° 24° 36°

Driver gear for LED: Non-Dimmable  
 1-10V Dimmable  
 DALI Dimmable  
 Triac Dimmable

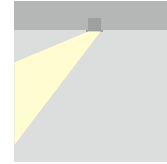

- The lamp housing is made of steel sheet.
- Mounting frame: Cast aluminum.
- Spot light source holder rings: Cast aluminum, they are positioned on adjustable gimbals and equipped with mechanical locking devices which allow an inclination of each light source by ±45° in relation to the horizontal and vertical axis.
- Light source: COB LED with a lens of optical.
- The light can be compatible with emergency battery.

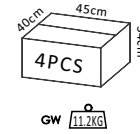
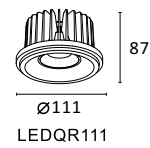
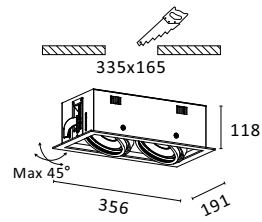

**R6207 2x15W 3400lm**  
 With 2 pieces of LED Driver 36V-350mA  
 230V-50Hz

NW  
 2.95kg

h(m)	D(m)	Em(lx)	Emax(lx)
1	0.5	748	2991
2	0.9	262	748
3	1.4	149	332
4	1.9	103	187
4	2.3	78	120

h(m)	D(m)	Em(lx)	Emax(lx)
1	0.5	728	2913
2	1.1	255	728
3	1.6	146	324
4	2.2	100	182
4	2.7	76	117

h(m)	D(m)	Em(lx)	Emax(lx)
1	0.7	493	1972
2	1.4	173	493
3	2.1	99	219
4	2.8	68	123
4	3.4	51	79

**R6179 2x20W 4640lm**  
 With 2 pieces of LED Driver 36V-500mA  
 230V-50Hz

NW  
 2.95kg

h(m)	D(m)	Em(lx)	Emax(lx)
1	0.5	1110	4441
2	0.9	389	1110
3	1.4	222	493
4	1.8	153	278
5	2.3	116	178

h(m)	D(m)	Em(lx)	Emax(lx)
1	0.5	1018	4073
2	1.1	356	1018
3	1.6	203	452
4	2.1	140	255
5	2.7	106	163

h(m)	D(m)	Em(lx)	Emax(lx)
1	0.7	679	2716
2	1.4	238	679
3	2.1	136	302
4	2.8	94	170
5	3.4	71	109

**R6192 2x25W 5500lm**  
 With 2 pieces of LED Driver 36V-600mA  
 230V-50Hz

NW  
 2.95kg

h(m)	D(m)	Em(lx)	Emax(lx)
1	0.9	289	1155
2	1.4	180	513
3	1.9	130	289
4	2.3	102	185
5	2.8	83	128

h(m)	D(m)	Em(lx)	Emax(lx)
1	0.6	1136	4543
2	1.1	398	1136
3	1.7	227	505
4	2.3	156	284
5	2.9	118	182

h(m)	D(m)	Em(lx)	Emax(lx)
1	0.4	755	3018
2	0.8	264	754
3	1.2	151	335
4	1.7	104	189
5	2.1	79	121





**LED QR111 CRI≥80 IP20 CE RoHS**

Mounting frame color: White Silver Black  
 Color temperature: 2700K 3000K 4000K  
 Beam angle: 15° 24° 36°

Driver gear for LED: Non-Dimmable  
 1-10V Dimmable  
 DALI Dimmable  
 Triac Dimmable

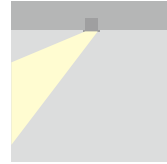

- The lamp housing is made of steel sheet.
- Mounting frame: Cast aluminum.
- Spot light source holder rings: Cast aluminum, they are positioned on adjustable gimbals and equipped with mechanical locking devices which allow an inclination of each light source by ±45° in relation to the horizontal and vertical axis.
- Light source: COB LED with a lens of optical.
- The light can be compatible with emergency battery.

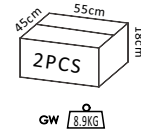
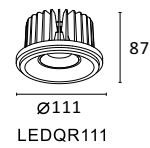
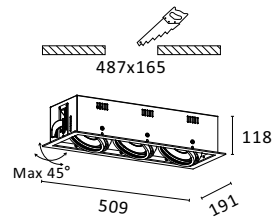

**R6208 3x15W 5100lm**  
 With 3 pieces of LED Driver 36V-350mA  
 230V-50Hz

NW  
 4.12kg

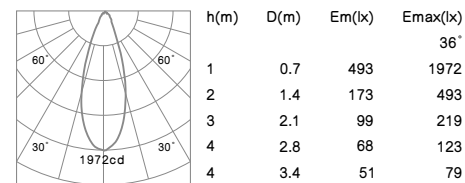
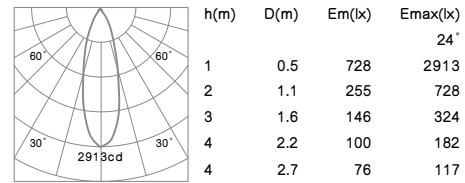
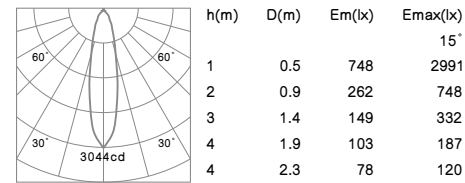

**R6180 3x20W 6960lm**  
 With 3 pieces of LED Driver 36V-500mA  
 230V-50Hz

NW  
 4.12kg

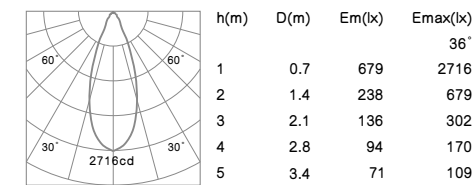
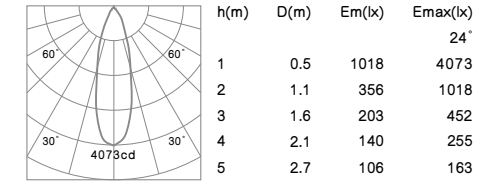
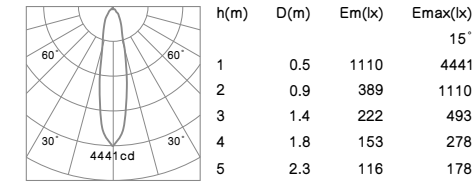

**R6193 3x25W 8250lm**  
 With 3 pieces of LED Driver 36V-600mA  
 230V-50Hz

NW  
 4.12kg

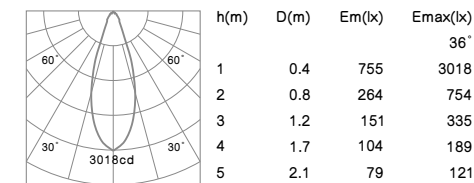
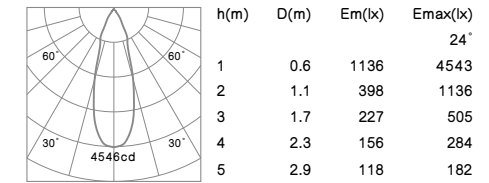
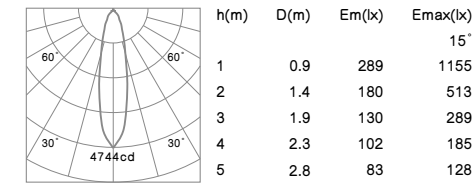

**BOX Invisible L**



**LED QR111 CRI≥80 IP20 CE RoHS**

Mounting frame color: White Silver Black  
 Color temperature: 2700K 3000K 4000K  
 Beam angle: 15° 24° 36°

Driver gear for LED: Non-Dimmable  
 1-10V Dimmable  
 DALI Dimmable  
 Triac Dimmable

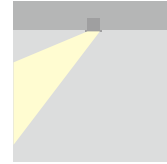

- This fixture has one mounting frame which is made of Cast aluminum.
- Mounting fixed kit: Steel sheet, for flush-mounting installation in plasterboard ceilings.
- Spot light source holder rings: Cast aluminum, they are positioned on adjustable gimbals and equipped with mechanical locking devices which allow an inclination of each light source by ±45° in relation to the horizontal and vertical axis.
- Light source: COB LED with a lens of optical.
- The light can be compatible with emergency battery.

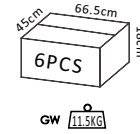
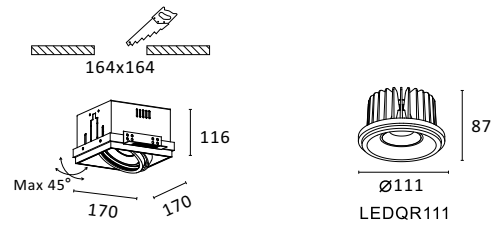

**R6203 15W 1700lm**  
 With LED Driver 36V-350mA  
 230V-50Hz

NW  
 1.68kg

h(m)	D(m)	Em(lx)	Emax(lx)
1	0.5	748	2991
2	0.9	262	748
3	1.4	149	332
4	1.9	103	187
4	2.3	78	120

h(m)	D(m)	Em(lx)	Emax(lx)
1	0.5	728	2913
2	1.1	255	728
3	1.6	146	324
4	2.2	100	182
4	2.7	76	117

h(m)	D(m)	Em(lx)	Emax(lx)
1	0.7	493	1972
2	1.4	173	493
3	2.1	99	219
4	2.8	68	123
4	3.4	51	79

h(m)	D(m)	Em(lx)	Emax(lx)
1	0.7	679	2716
2	1.4	238	679
3	2.1	136	302
4	2.8	94	170
5	3.4	71	109

**BOX Invisible L**

**R6175 20W 2320lm**  
 With LED Driver 36V-500mA  
 230V-50Hz

NW  
 1.68kg

h(m)	D(m)	Em(lx)	Emax(lx)
1	0.5	1110	4441
2	0.9	389	1110
3	1.4	222	493
4	1.8	153	278
5	2.3	116	178

h(m)	D(m)	Em(lx)	Emax(lx)
1	0.5	1018	4073
2	1.1	356	1018
3	1.6	203	452
4	2.1	140	255
5	2.7	106	163

h(m)	D(m)	Em(lx)	Emax(lx)
1	0.7	679	2716
2	1.4	238	679
3	2.1	136	302
4	2.8	94	170
5	3.4	71	109

**R6288 25W 2750lm**  
 With LED Driver 36V-600mA  
 230V-50Hz

NW  
 1.68kg

h(m)	D(m)	Em(lx)	Emax(lx)
1	0.9	289	1155
2	1.4	180	513
3	1.9	130	289
4	2.3	102	185
5	2.8	83	128

h(m)	D(m)	Em(lx)	Emax(lx)
1	0.6	1136	4543
2	1.1	398	1136
3	1.7	227	505
4	2.3	156	284
5	2.9	118	182

h(m)	D(m)	Em(lx)	Emax(lx)
1	0.4	755	3018
2	0.8	264	754
3	1.2	151	335
4	1.7	104	189
5	2.1	79	121

h(m)	D(m)	Em(lx)	Emax(lx)
1	0.7	493	1972
2	1.4	173	493
3	2.1	99	219
4	2.8	68	123
4	3.4	51	79

**BOX Invisible LD**



**LED QR111 CRi≥80 IP20 CE RoHS**  
 Mounting frame color: White Silver Black  
 Color temperature: 2700K 3000K 4000K  
 Beam angle: 15° 24° 36°

Driver gear for LED:  
 Non-Dimmable  
 1-10V Dimmable  
 DALI Dimmable  
 Triac Dimmable

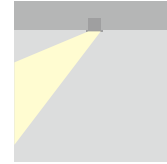

- This fixture has one mounting frame which is made of Cast aluminum.
- Mounting fixed kit: Steel sheet, for flush-mounting installation in plasterboard ceilings.
- Spot light source holder rings: Cast aluminum, they are positioned on adjustable gimbals and equipped with mechanical locking devices which allow an inclination of each light source by ±45° in relation to the horizontal and vertical axis.
- Light source: COB LED with a lens of optical.
- The light can be compatible with emergency battery.

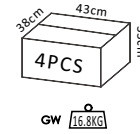
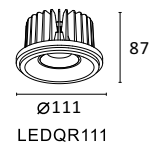
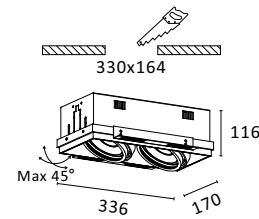

**R6204 2x15W 3400lm**  
 With 2 pieces of LED Driver 36V-350mA  
 230V-50Hz

NW  
 2,94kg

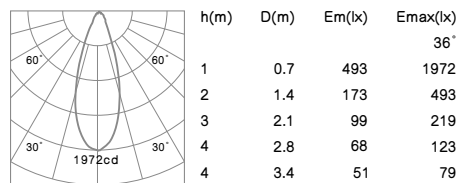
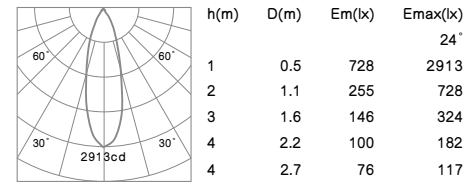
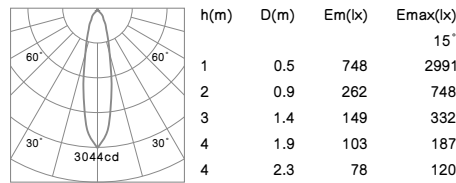

**R6289 2x25W 5500lm**  
 With 2 pieces of LED Driver 36V-600mA  
 230V-50Hz

NW  
 2,94kg

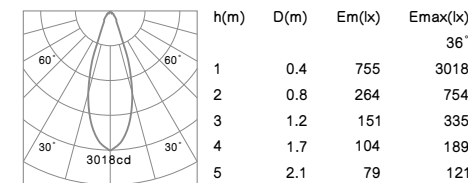
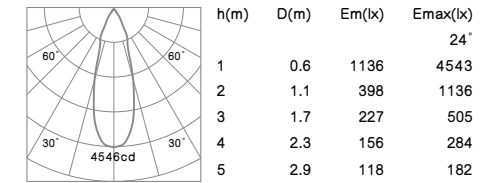
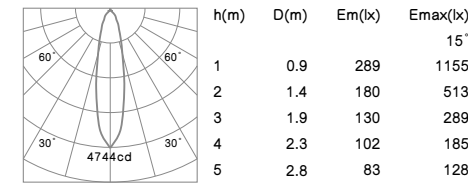

**BOX Invisible LD**

**R6176 2x20W 4640lm**  
 With 2 pieces of LED Driver 36V-500mA  
 230V-50Hz

NW  
 2,94kg

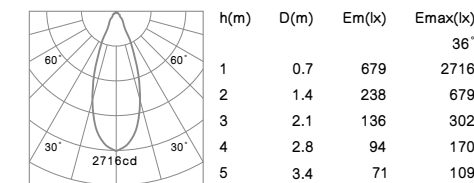
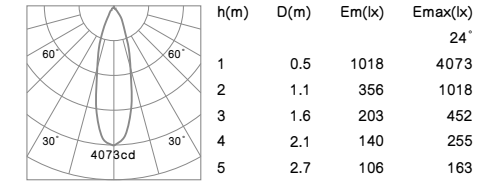
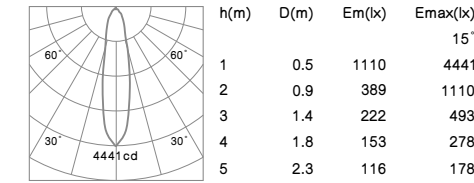

# BOX

Invisible LT



**LED QR111 CRI≥80 IP20 CE RoHS**  
 Mounting frame color: White Silver Black  
 Color temperature: 2700K 3000K 4000K  
 Beam angle: 15° 24° 36°

Driver gear for LED:  
 Non-Dimmable  
 1-10V Dimmable  
 DALI Dimmable  
 Triac Dimmable

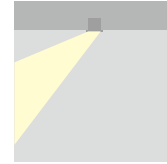

- This fixture has one mounting frame which is made of Cast aluminum.
- Mounting fixed kit: Steel sheet, for flush-mounting installation in plasterboard ceilings.
- Spot light source holder rings: Cast aluminum, they are positioned on adjustable gimbals and equipped with mechanical locking devices which allow an inclination of each light source by ±45° in relation to the horizontal and vertical axis.
- Light source: COB LED with a lens of optical.
- The light can be compatible with emergency battery.

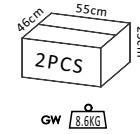
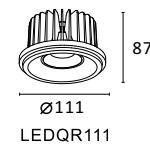
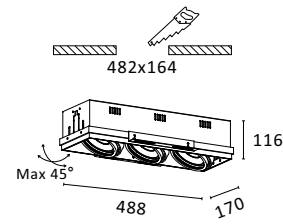

## R6205 3x15W 5100lm

With 3 pieces of LED Driver 36V-350mA  
 230V-50Hz

NW  
 Ω  
 4.30kg

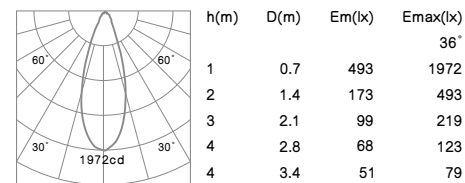
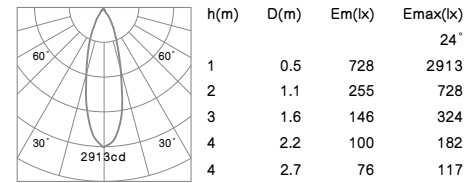
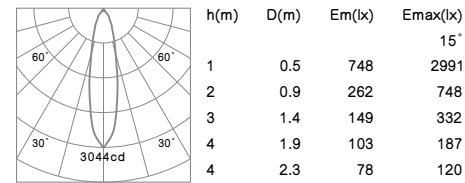

# BOX

Invisible LT

## R6177 3x20W 6960lm

With 3 pieces of LED Driver 36V-500mA  
 230V-50Hz

NW  
 Ω  
 4.30kg

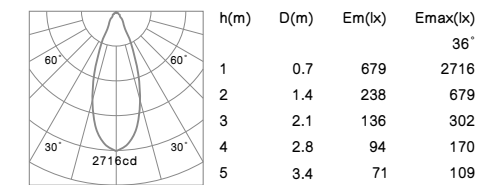
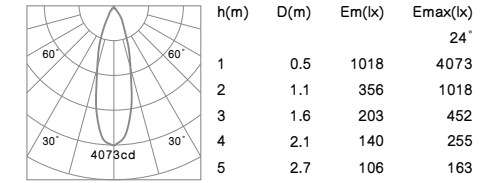
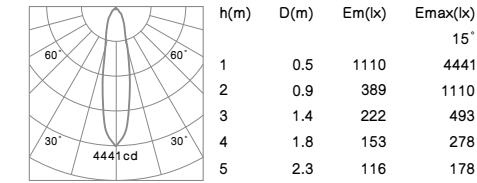

## R6290 3x25W 8250lm

With 3 pieces of LED Driver 36V-600mA  
 230V-50Hz

NW  
 Ω  
 4.30kg

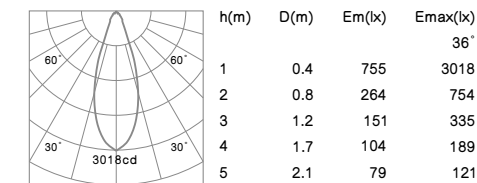
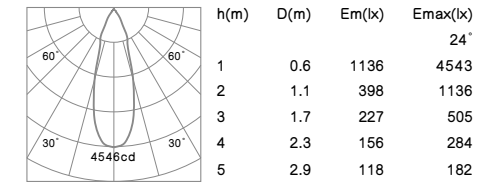
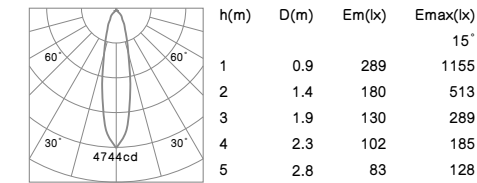



MILA



345

MILA



Spotlight adjustable 358° rotating around the vertical axis and 75° rotating around the horizontal axis.

346



Ø 102mm 6W 10W

P349



Ø 125mm 6W 10W

P351



□ 120x120mm 6W 10W

P353

# MILA



**COB LED CRI≥80 IP20 CE RoHS**

Housing color: White Silver Black  
 Color temperature: 2700K 3000K 4000K  
 Beam angle: 15° 24° 36° 60°

Driver gear for LED:  
 Non-Dimmable  
 1-10V Dimmable  
 DALI Dimmable  
 Triac Dimmable

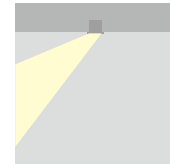

- Housing: Cast aluminum.
- Spotlight adjustable 358° rotating around the vertical axis and 90° rotating around the horizontal axis.
- Anti-dazzle ring: Aluminum black.
- Light source: COB LED with a high efficiency reflector of optical.

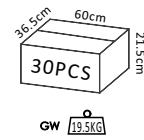
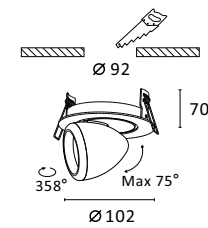

**R6918 6W 520lm**  
 With LED Driver 36V-135mA  
 230V-50Hz

NW  
 0.35kg

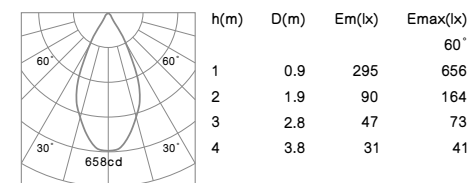
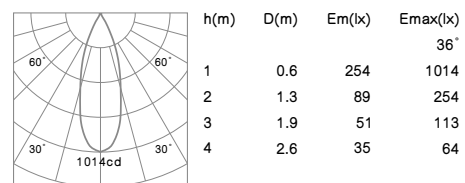
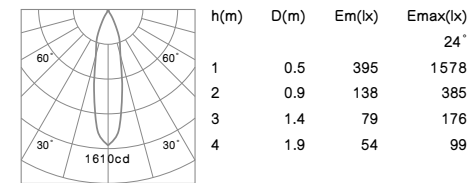
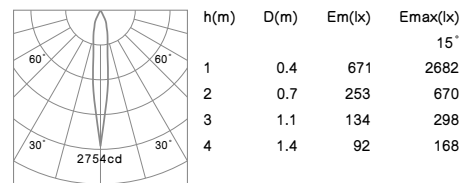

# MILA

**R6918 10W 890lm**  
 With LED Driver 36V-250mA  
 230V-50Hz

NW  
 0.35kg

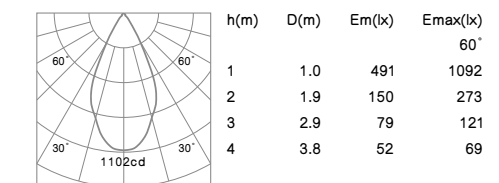
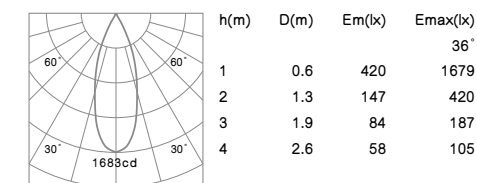
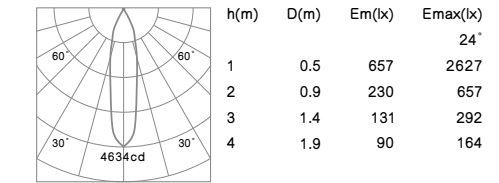
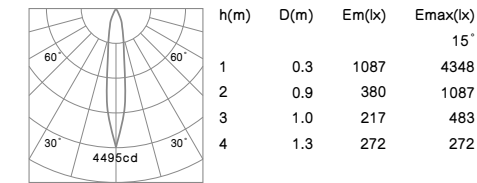



# MILA



**COB LED CRI≥80 IP20 CE RoHS**

Housing color: White Silver Black  
 Color temperature: 2700K 3000K 4000K  
 Beam angle: 15° 24° 36° 60°

Driver gear for LED:  
 Non-Dimmable  
 1-10V Dimmable  
 DALI Dimmable  
 Triac Dimmable

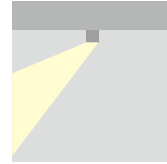

- Housing: Cast aluminum+pure aluminum.
- Spotlight adjustable 358° rotating around the vertical axis and 90° rotating around the horizontal axis.
- Mounting ring: Pure aluminum.
- Anti-dazzle ring: Aluminum black.
- Light source: COB LED with a high efficiency reflector of optical.

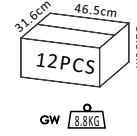
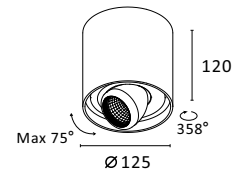

**C6027 6W 520lm**  
 With LED Driver 36V-135mA  
 230V-50Hz

NW  
 0.97kg

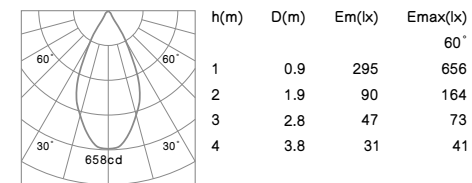
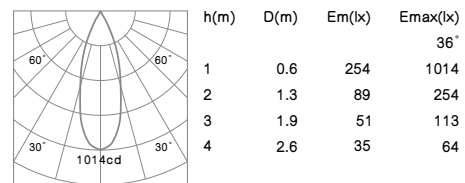
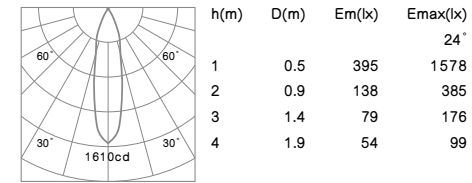
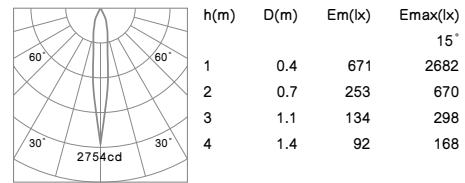

# MILA

**C6027 10W 890lm**  
 With LED Driver 36V-250mA  
 230V-50Hz

NW  
 0.97kg

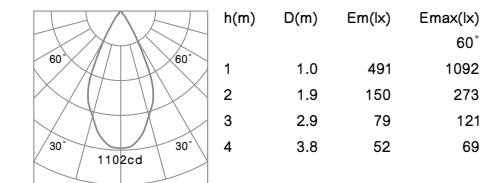
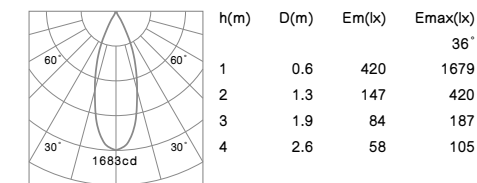
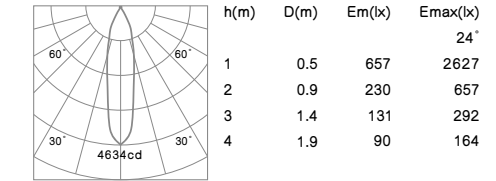
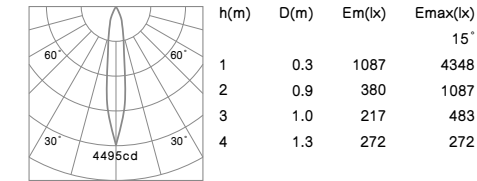



# MILA



**COB LED CRI≥80 IP20 CE RoHS**

Housing color: White Silver Black  
 Color temperature: 2700K 3000K 4000K  
 Beam angle: 15° 24° 36° 60°

Driver gear for LED:  
 Non-Dimmable  
 1-10V Dimmable  
 DALI Dimmable  
 Triac Dimmable

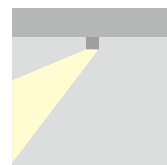

- Housing: Cast aluminum+pure aluminum.
- Spotlight adjustable 358° rotating around the vertical axis and 90° rotating around the horizontal axis.
- Mounting ring: Pure aluminum.
- Anti-dazzle ring: Aluminum black.
- Light source: COB LED with a high efficiency reflector of optical.

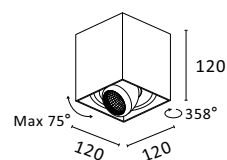

COB LED

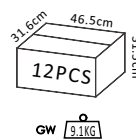

**C6028 6W 520lm**  
 With LED Driver 36V-135mA  
 230V-50Hz

NW  
 0.99kg

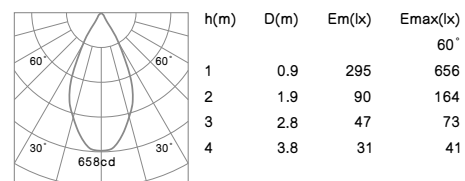
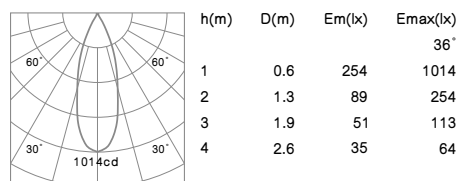
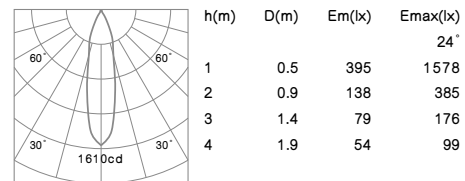
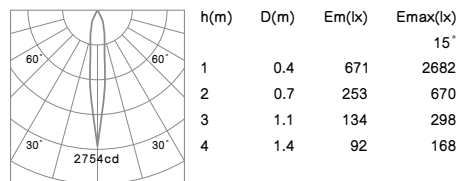

# MILA

**C6028 10W 890lm**  
 With LED Driver 36V-250mA  
 230V-50Hz

NW  
 0.99kg

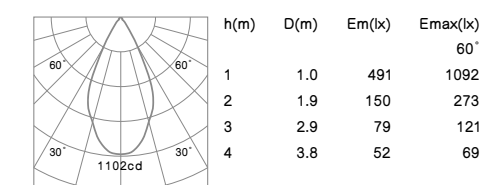
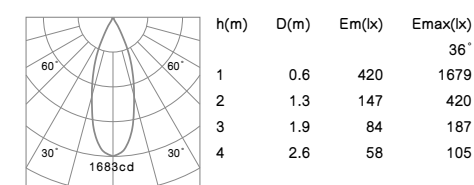
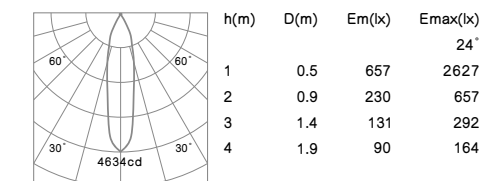
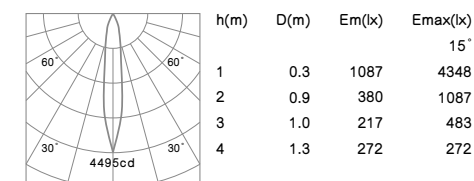

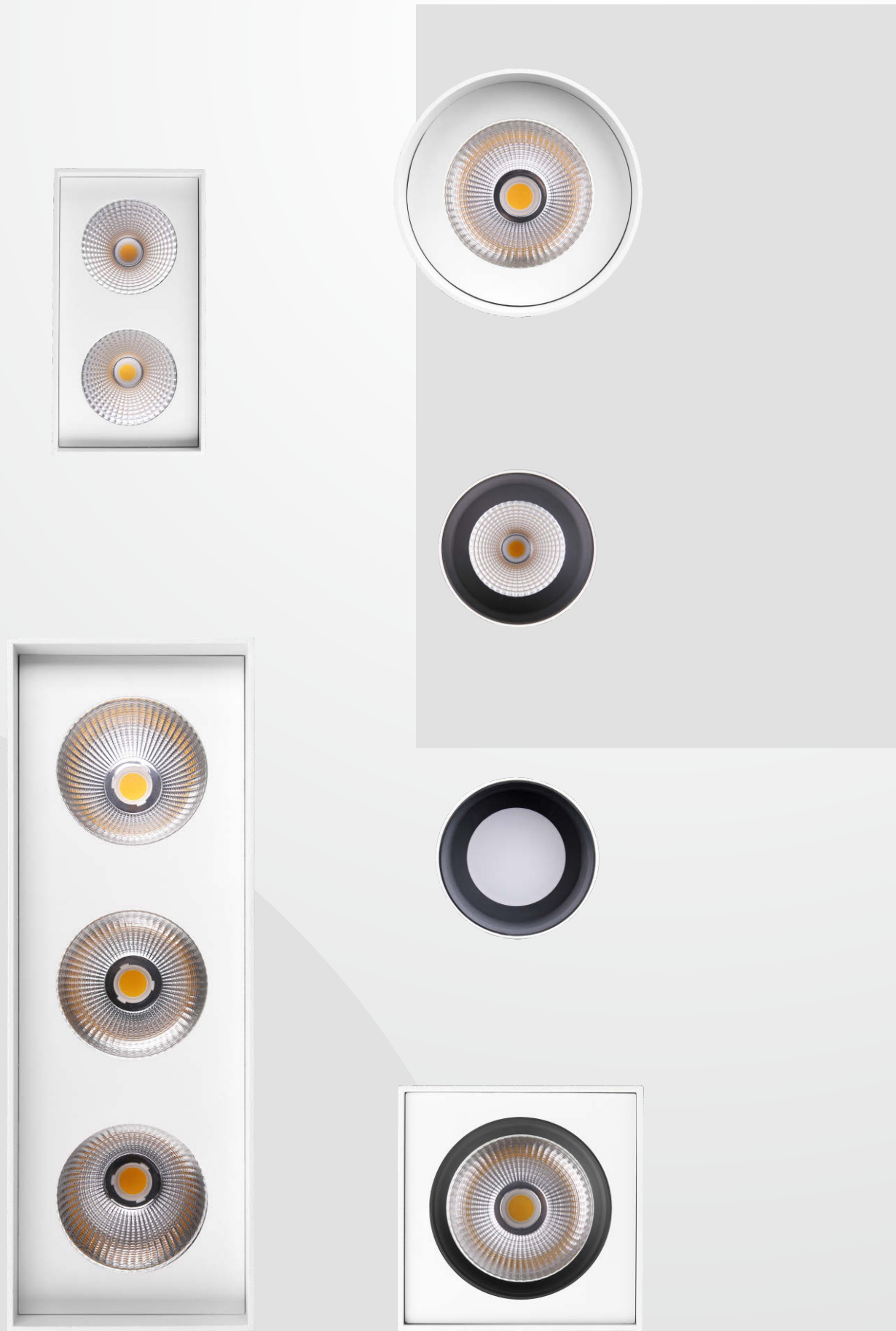

- Screwless structure, the installation is more simple and efficient.
- Round, Square, and various sizes to meet different application.
- Different wattage to meet different lighting solution.

Suitable for:

C6021 / C6024 / C6025 / C6033 / C6035 / C6036 / C6038

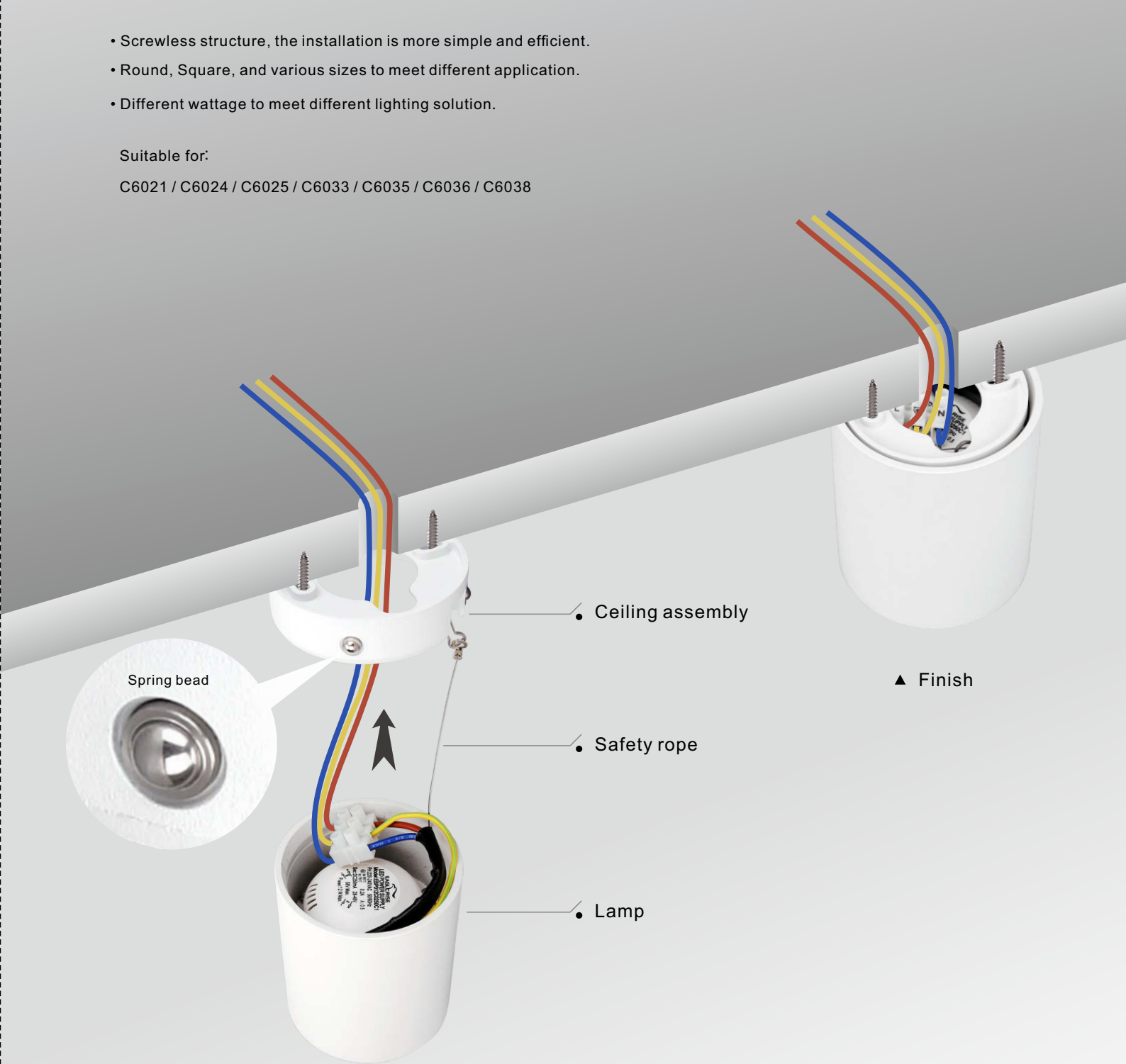

**INSTALLATION**

of the new struction surface-mounted lights

TOPO



For sizes  
Ø 80mm 80x80mm



357

TOPO



### Multi-directional Structure

The spot light tilts to a maximum of 0°-25° onto the vertical plane  
and it is available for 360° horizontal plane.



358

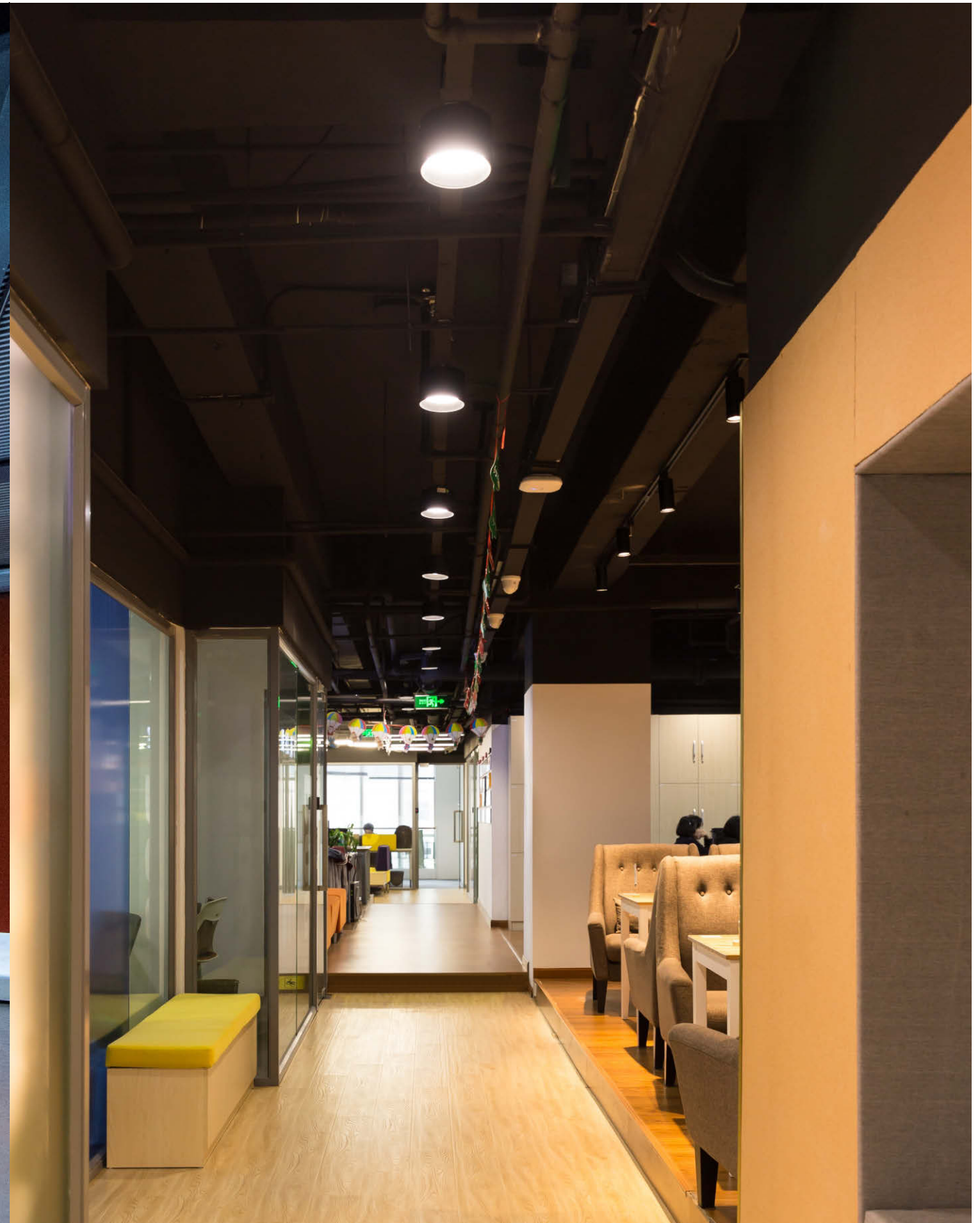





## TOPO

	S	∅ 80mm	6W	P363
	S	∅ 80mm	6W 10W	P364
	S	□ 80x80mm	6W 10W	P365
	SD	□ 80x150mm	2x6W 2x10W	P366
	L	∅ 125mm	15W 20W	P367
	L	□ 120x120mm	15W 20W	P368
	L	∅ 125mm	20W 25W	P369
	L	□ 120x120mm	20W 25W	P370
	LD	□ 120x230mm	2x15W 2x20W	P371
	LT	□ 120x340mm	3x15W 3x20W	P372

## TOPO

### Anti-glare & Clear Glass

	S	∅ 80mm	6W 10W	P373
	S	□ 80x80mm	6W 10W	P374
	L	∅ 125mm	15W 20W	P375
	L	□ 120x120mm	15W 20W	P376

### Anti-glare & Diffuser

	S	∅ 80mm	6W 10W	P377
	S	□ 80x80mm	6W 10W	P378
	L	∅ 125mm	15W 20W	P379
	L	□ 120x120mm	15W 20W	P380



**COB LED CRI≥80 IP20 CE RoHS**  
 Housing color: White Silver Black  
 Color temperature: 2700K 3000K 4000K  
 Beam angle: 24° 36° 60°

- Luminaire housing: Pure aluminum.
- Ceiling mouted plate: Cast aluminum.
- The spot light tilts to a maximum of 0°-25° onto the vertical plane and it is available for 360° horizontal plane.
- Light source: COB LED with a lens of optical.

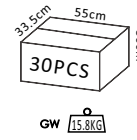
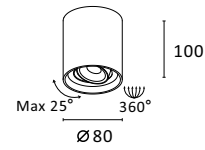

**C6021 6W 650lm**  
 With LED Driver 36V-150mA  
 230V-50Hz

NW  
 0.44kg

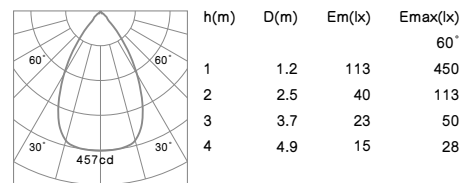
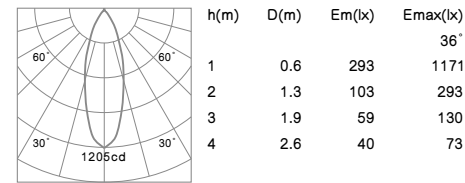
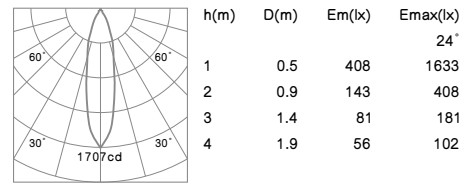

**COB LED CRI≥80 IP44 CE RoHS**  
 Housing color: White Silver Black  
 Color temperature: 2700K 3000K 4000K  
 Beam angle: 45°

- Luminaire housing: Pure aluminum.
- Ceiling mouted plate: Cast aluminum.
- Light source: COB LED with a high efficiency .

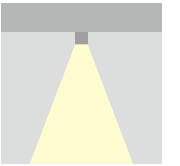
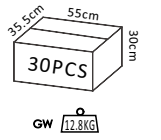
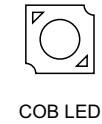
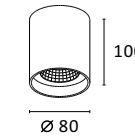

**C6025 6W 630lm**  
 With LED Driver 36V-150mA  
 230V-50Hz

NW  
 0.44kg

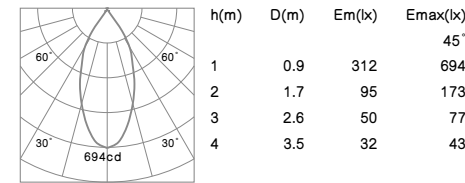

**C6025 10W 1120lm**  
 With LED Driver 36V-250mA  
 230V-50Hz

NW  
 0.44kg

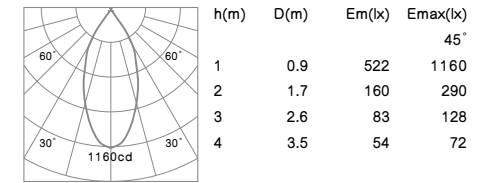

TOPO s



**COB LED CRI≥80 IP44 CE RoHS**  
 Housing color: White Silver Black  
 Color temperature: 2700K 3000K 4000K  
 Beam angle: 45°

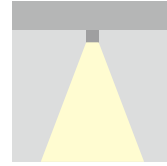

- Luminaire housing: Pure aluminum.
- Ceiling mouted plate: Cast aluminum.
- Light source: COB LED with a high efficiency reflector of optical.

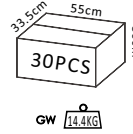
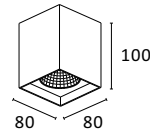

**C6024 6W 630lm**  
 With LED Driver 36V-150mA  
 230V-50Hz

NW  
 0.41kg

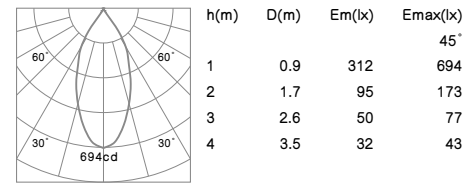

**C6024 10W 1120lm**  
 With LED Driver 36V-250mA  
 230V-50Hz

NW  
 0.41kg

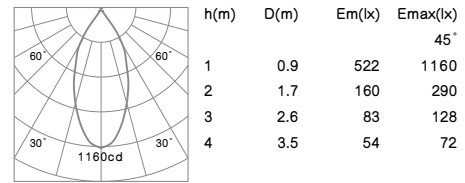

TOPO SD



**COB LED CRI≥80 IP44 CE RoHS**  
 Housing color: White Silver Black  
 Color temperature: 2700K 3000K 4000K  
 Beam angle: 45°

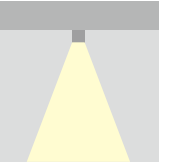

- Luminaire housing: Pure aluminum.
- Ceiling mouted plate: Steel sheet.
- Light source: COB LED with a high efficiency reflector of optical.

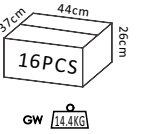
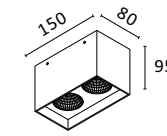

**C6234 2X6W 1250lm**  
 With 2 pieces of LED Driver 36V-150mA  
 230V-50Hz

NW  
 0.71kg

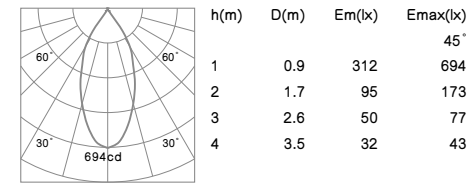

**C6234 2X10W 2000lm**  
 With 2 pieces of LED Driver 36V-250mA  
 230V-50Hz

NW  
 0.71kg

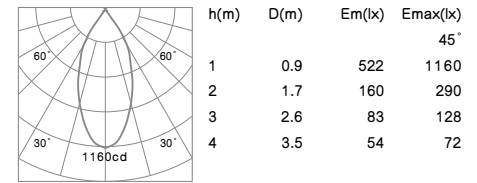

# TOPO L



**COB LED CRI≥80 IP44 CE RoHS**  
 Housing color: White Silver Black  
 Color temperature: 2700K 3000K 4000K  
 Beam angle: 50°

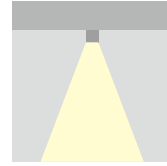

- Luminaire housing: Pure aluminum.
- Ceiling mouted plate: Steel sheet.
- Light source: COB LED with a high efficiency reflector of optical.

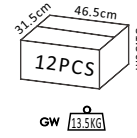
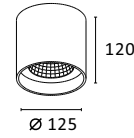

**C6045 15W 1600lm**  
 With LED Driver 36V-350mA  
 230V-50Hz

NW  
 0.91kg

	h(m)	D(m)	Em(lx)	Emax(lx)
				50°
	1	0.8	943	2095
	2	1.7	288	523
	3	2.5	151	232
	4	3.4	98	130
	5	4.2	66	83

**C6045 20W 2200lm**  
 With LED Driver 36V-500mA  
 230V-50Hz

NW  
 0.91kg

	h(m)	D(m)	Em(lx)	Emax(lx)
				50°
	1	0.8	1308	2906
	2	1.7	399	726
	3	2.5	210	323
	4	3.4	136	181
	5	4.2	93	116

# TOPO L

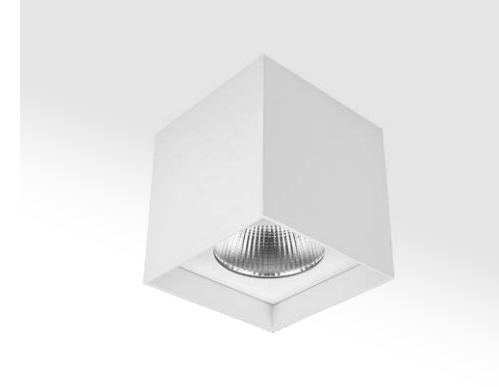

**COB LED CRI≥80 IP44 CE RoHS**  
 Housing color: White Silver Black  
 Color temperature: 2700K 3000K 4000K  
 Beam angle: 50°

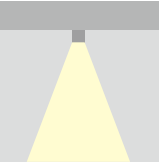

- Luminaire housing: Pure aluminum.
- Ceiling mouted plate: Steel sheet.
- Light source: COB LED with a high efficiency reflector of optical.

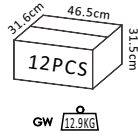
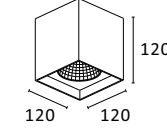

**C6044 15W 1620lm**  
 With LED Driver 36V-350mA  
 230V-50Hz

NW  
 1.01kg

	h(m)	D(m)	Em(lx)	Emax(lx)
				50°
	1	0.8	943	2095
	2	1.7	288	523
	3	2.5	151	232
	4	3.4	98	130
	5	4.2	66	83

**C6044 20W 2220lm**  
 With LED Driver 36V-500mA  
 230V-50Hz

NW  
 1.01kg

	h(m)	D(m)	Em(lx)	Emax(lx)
				50°
	1	0.8	1308	2906
	2	1.7	399	726
	3	2.5	210	323
	4	3.4	136	181
	5	4.2	93	116



# TOPO L



**COB LED CRI≥80 IP44 CE RoHS**

Housing color: White Silver Black  
 Color temperature: 2700K 3000K 4000K  
 Beam angle: 50°

Driver gear for LED: Non-Dimmable  
 1-10V Dimmable  
 DALI Dimmable  
 Triac Dimmable

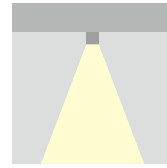

- Luminaire housing: Pure aluminum.
- Ceiling mouted plate: Steel sheet.
- Light source: COB LED with a high efficiency reflector of optical.

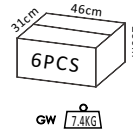
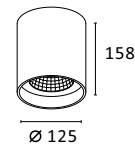

**C6221 20W 2200lm**  
 With LED Driver 36V-500mA  
 230V-50Hz

NW  
 1.03kg

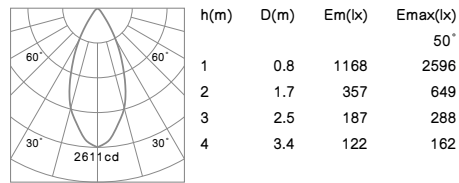

**C6221 25W 2500lm**  
 With LED Driver 36V-600mA  
 230V-50Hz

NW  
 1.03kg

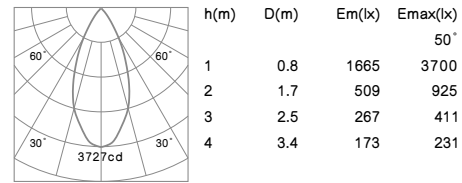

# TOPO L



**COB LED CRI≥80 IP44 CE RoHS**

Housing color: White Silver Black  
 Color temperature: 2700K 3000K 4000K  
 Beam angle: 50°

Driver gear for LED: Non-Dimmable  
 1-10V Dimmable  
 DALI Dimmable  
 Triac Dimmable

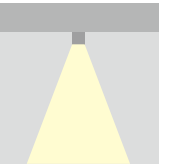

- Luminaire housing: Pure aluminum.
- Ceiling mouted plate: Steel sheet.
- Light source: COB LED with a high efficiency reflector of optical.

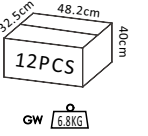
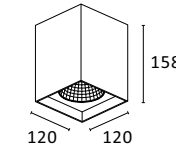

**C6062 20W 2000lm**  
 With LED Driver 36V-500mA  
 230V-50Hz

NW  
 0.94kg

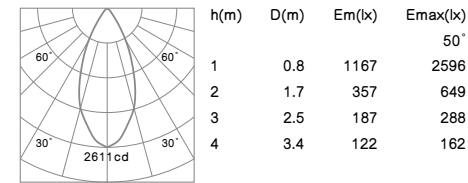

**C6062 25W 2540lm**  
 With LED Driver 36V-600mA  
 230V-50Hz

NW  
 0.94kg

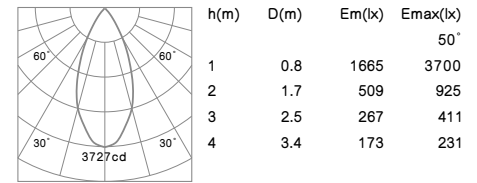

# TOPO LD



**COB LED CRI≥80 IP44 CE RoHS**

Housing color: White Silver Black  
 Color temperature: 2700K 3000K 4000K  
 Beam angle: 50°

Driver gear for LED: Non-Dimmable  
 1-10V Dimmable  
 DALI Dimmable  
 Triac Dimmable

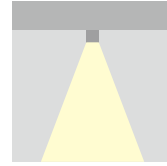

- Luminaire housing: Pure aluminum.
- Ceiling mouted plate: Steel sheet.
- Light source: COB LED with a high efficiency reflector of optical.

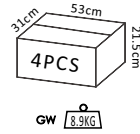
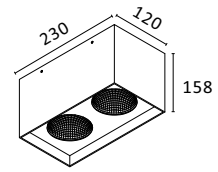

**C6264 2X15W 2700lm**  
 With 2 pieces of LED Driver 36V-350mA  
 230V-50Hz

NW  
 1.83kg

h(m)	D(m)	Em(lx)	E <sub>max</sub> (lx)
1	0.8	943	2095
2	1.7	288	523
3	2.5	151	232
4	3.4	98	130
5	4.2	66	83

**C6264 2X20W 4200lm**  
 With 2 pieces of LED Driver 36V-500mA  
 230V-50Hz

NW  
 1.83kg

h(m)	D(m)	Em(lx)	E <sub>max</sub> (lx)
1	0.8	1308	2906
2	1.7	399	726
3	2.5	210	323
4	3.4	136	181
5	4.2	93	116

# TOPO LT



**COB LED CRI≥80 IP44 CE RoHS**

Housing color: White Silver Black  
 Color temperature: 2700K 3000K 4000K  
 Beam angle: 50°

Driver gear for LED: Non-Dimmable  
 1-10V Dimmable  
 DALI Dimmable  
 Triac Dimmable

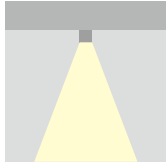

- Luminaire housing: Pure aluminum.
- Ceiling mouted plate: Steel sheet.
- Light source: COB LED with a high efficiency reflector of optical.

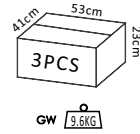
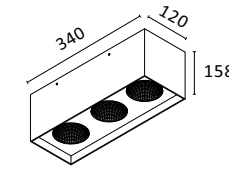

**C6290 3X15W 4100lm**  
 With 3 pieces of LED Driver 36V-350mA  
 230V-50Hz

NW  
 2.67kg

h(m)	D(m)	Em(lx)	E <sub>max</sub> (lx)
1	0.8	943	2095
2	1.7	288	523
3	2.5	151	232
4	3.4	98	130
5	4.2	66	83

**C6290 3X20W 6200lm**  
 With 3 pieces of LED Driver 36V-500mA  
 230V-50Hz

NW  
 2.67kg

h(m)	D(m)	Em(lx)	E <sub>max</sub> (lx)
1	0.8	1308	2906
2	1.7	399	726
3	2.5	210	323
4	3.4	136	181
5	4.2	93	116

TOPO s



**COB LED CRI≥80 IP44 CE RoHS**  
 Housing color: White Silver Black  
 Color temperature: 2700K 3000K 4000K  
 Beam angle: 45°

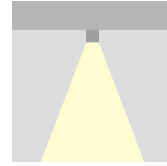

- Luminaire housing: Pure aluminum.
- Ceiling mouted plate: Steel sheet.
- Light source: COB LED with a high efficiency reflector of optical.
- Anti-dazzle ring: Aluminum black.
- UGR<19.

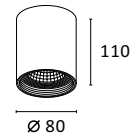

COB LED

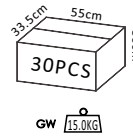

GW 15.0KG

**C6035 6W 520lm**  
 With LED Driver 36V-150mA  
 230V-50Hz

NW  
 0.41kg

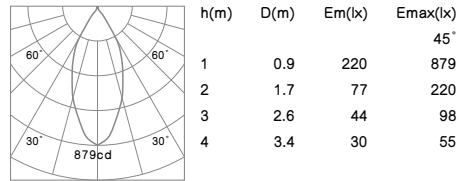

**C6035 10W 830lm**  
 With LED Driver 36V-250mA  
 230V-50Hz

NW  
 0.41kg

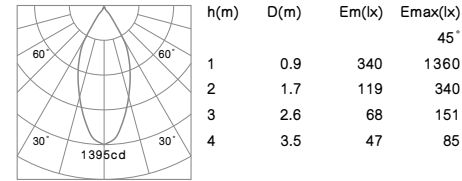

TOPO s

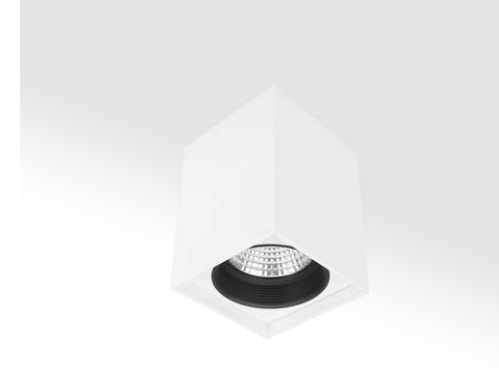

**COB LED CRI≥80 IP44 CE RoHS**  
 Housing color: White Silver Black  
 Color temperature: 2700K 3000K 4000K  
 Beam angle: 45°

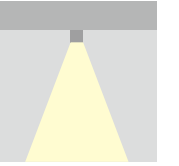

- Luminaire housing: Pure aluminum.
- Ceiling mouted plate: Steel sheet.
- Light source: COB LED with a high efficiency reflector of optical.
- Anti-dazzle ring: Aluminum black.
- UGR<19.

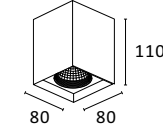

COB LED

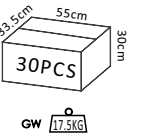

GW 17.5KG

**C6036 6W 520lm**  
 With LED Driver 36V-150mA  
 230V-50Hz

NW  
 0.49kg

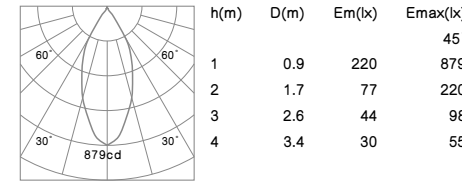

**C6036 10W 830lm**  
 With LED Driver 36V-250mA  
 230V-50Hz

NW  
 0.49kg

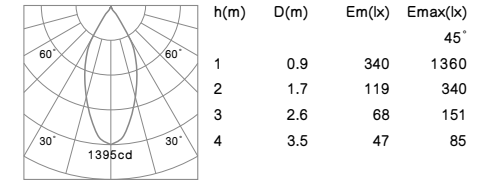

# TOPO L



**COB LED CRI≥80 IP44 CE RoHS**

Housing color: White Silver Black  
 Color temperature: 2700K 3000K 4000K  
 Beam angle: 50°

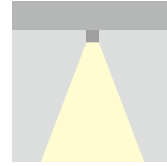

- Luminaire housing: Pure aluminum.
- Ceiling mouted plate: Steel sheet.
- Light source: COB LED with a high efficiency reflector of optical.
- Anti-dazzle ring: Aluminum black.
- UGR<19.

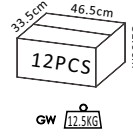
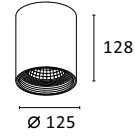

**C6051 15W 1410lm**  
 With LED Driver 36V-350mA  
 230V-50Hz

NW  
 0.91kg

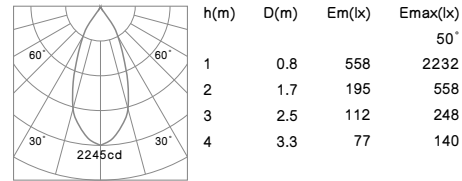

**C6051 20W 1900lm**  
 With LED Driver 36V-500mA  
 230V-50Hz

NW  
 0.91kg

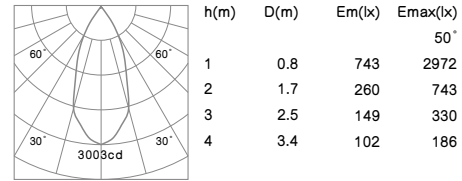

# TOPO L



**COB LED CRI≥80 IP44 CE RoHS**

Housing color: White Silver Black  
 Color temperature: 2700K 3000K 4000K  
 Beam angle: 50°

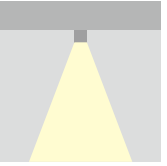

- Luminaire housing: Pure aluminum.
- Ceiling mouted plate: Steel sheet.
- Light source: COB LED with a high efficiency reflector of optical.
- Anti-dazzle ring: Aluminum black.
- UGR<19.

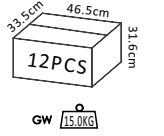
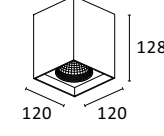

**C6052 15W 1410lm**  
 With LED Driver 36V-350mA  
 230V-50Hz

NW  
 1.09kg

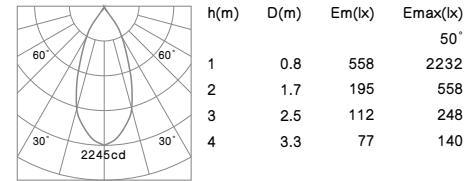

**C6052 20W 1900lm**  
 With LED Driver 36V-500mA  
 230V-50Hz

NW  
 1.09kg

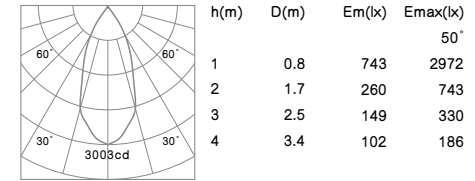



TOPO s



**COB LED CRI≥80 IP44 CE RoHS**  
 Housing color: White Silver Black  
 Color temperature: 2700K 3000K 4000K  
 Beam angle: 80°

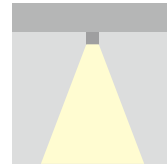

- Luminaire housing: Pure aluminum.
- Ceiling mouted plate: Steel sheet.
- Light source: COB LED with a high efficiency optical reflector and fogged diffuser.
- Anti-dazzle ring: Aluminum black.
- UGR<19.

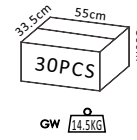
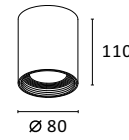

**C6033 6W 350lm**  
 With LED Driver 36V-150mA  
 230V-50Hz

NW  
 0.38kg

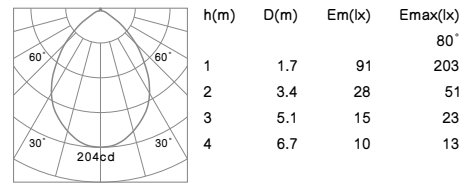

**C6033 10W 540lm**  
 With LED Driver 36V-250mA  
 230V-50Hz

NW  
 0.38kg

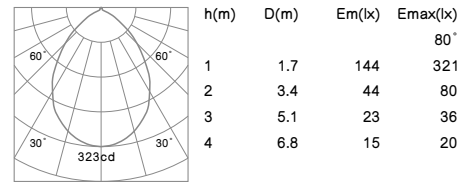

TOPO s

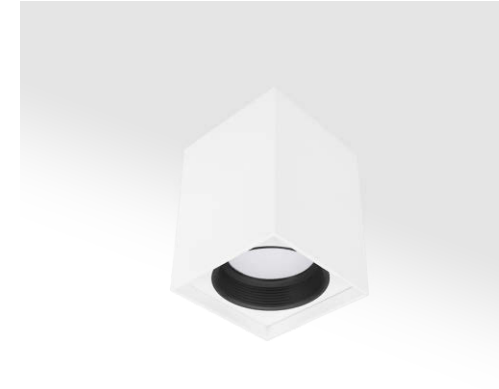

**COB LED CRI≥80 IP44 CE RoHS**  
 Housing color: White Silver Black  
 Color temperature: 2700K 3000K 4000K  
 Beam angle: 80°

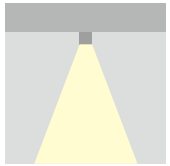

- Luminaire housing: Pure aluminum.
- Ceiling mouted plate: Steel sheet.
- Light source: COB LED with a high efficiency optical reflector and fogged diffuser.
- Anti-dazzle ring: Aluminum black.
- UGR<19.

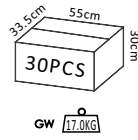
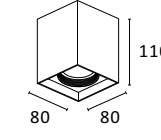

**C6038 6W 340lm**  
 With LED Driver 36V-150mA  
 230V-50Hz

NW  
 0.46kg

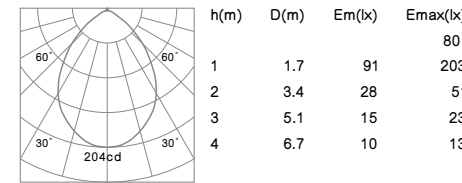

**C6038 10W 540lm**  
 With LED Driver 36V-250mA  
 230V-50Hz

NW  
 0.46kg

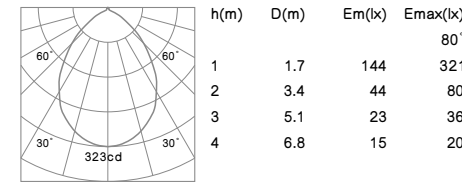

# TOPO L



**COB LED CRI≥80 IP44 CE RoHS**  
 Housing color: White Silver Black  
 Color temperature: 2700K 3000K 4000K  
 Beam angle: 60°

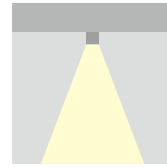

- Luminaire housing: Pure aluminum.
- Ceiling mouted plate: Steel sheet.
- Light source: COB LED with a high efficiency optical reflector and fogged diffuser.
- Anti-dazzle ring: Aluminum black.
- UGR<19.

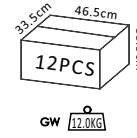
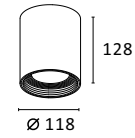

**C6046 15W 1100lm**  
 With LED Driver 36V-350mA  
 230V-50Hz

NW  
 0.86kg

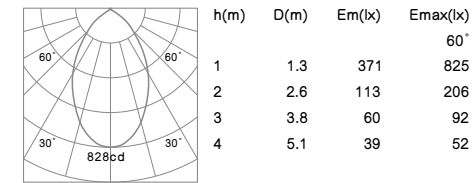

**C6046 20W 1470lm**  
 With LED Driver 36V-500mA  
 230V-50Hz

NW  
 0.86kg

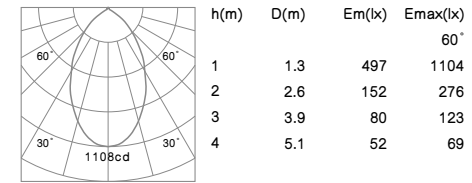

# TOPO L



**COB LED CRI≥80 IP44 CE RoHS**  
 Housing color: White Silver Black  
 Color temperature: 2700K 3000K 4000K  
 Beam angle: 60°

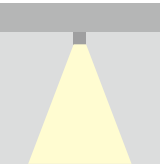

- Luminaire housing: Pure aluminum.
- Ceiling mouted plate: Steel sheet.
- Light source: COB LED with a high efficiency optical reflector and fogged diffuser.
- Anti-dazzle ring: Aluminum black.
- UGR<19.

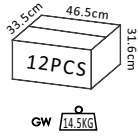
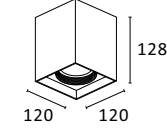

**C6049 15W 1100lm**  
 With LED Driver 36V-350mA  
 230V-50Hz

NW  
 1.04kg

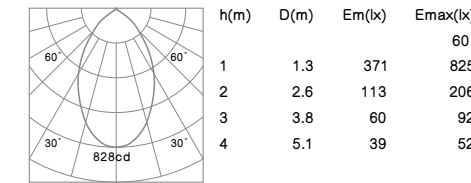

**C6049 20W 1470lm**  
 With LED Driver 36V-500mA  
 230V-50Hz

NW  
 1.04kg

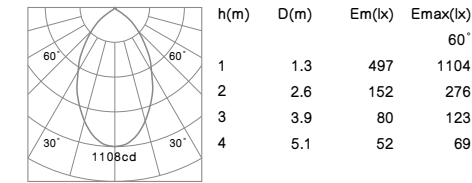

TODO



Cube



Cylinder

381

TODO



382



TODO



383

TODO

Surface-mounted



Ø 125mm

15W 20W

P385



□ 120x120mm

15W 20W

P386

Pendant



Ø 125mm

15W 20W

P387



□ 120x120mm

15W 20W

P388

384



**TODO** Surface-mounted



**LED QR111 CRI≥80 IP20 CE RoHS**

Housing color: White Silver Black  
 Color temperature: 2700K 3000K 4000K  
 Beam angle: 15° 24° 36°

Driver gear for LED: Non-Dimmable  
 1-10V Dimmable  
 Triac Dimmable

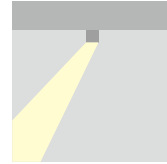

- Luminaire housing: Pure aluminum.
- Ceiling mouted plate: Steel sheet.
- The spot light tilts to a maximum of 0°-25° onto the vertical plane and rotates by 358° onto the horizontal plane.
- Light source: COB LED with a lens of optical.

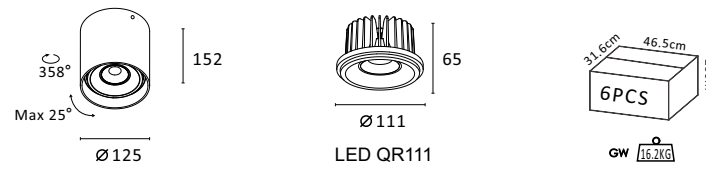

**C6004 15W 1670lm**  
 With LED Driver 36V-350mA  
 230V-50Hz

NW  
 1.19kg

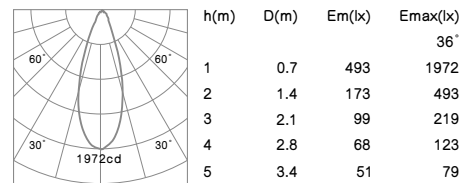
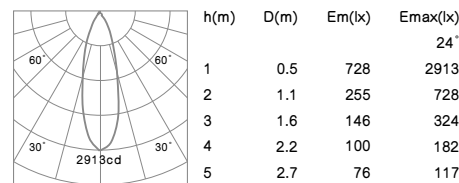
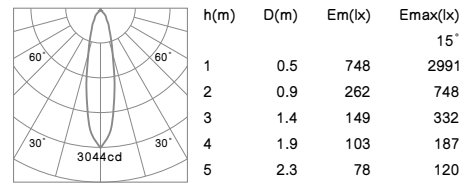

**C6005 20W 2300lm**  
 With LED Driver 36V-500mA  
 230V-50Hz

NW  
 1.19kg

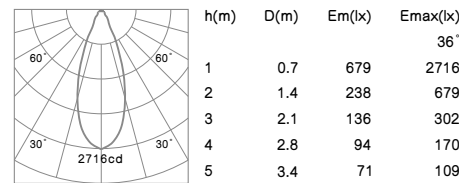
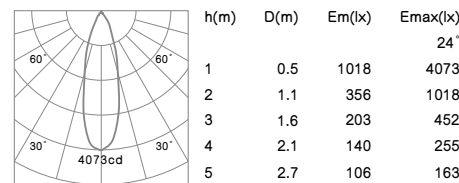
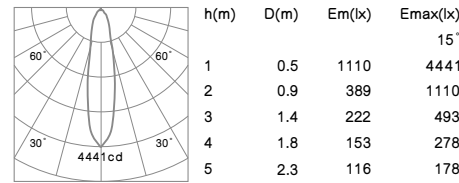

**TODO** Surface-mounted



**LED QR111 CRI≥80 IP20 CE RoHS**

Housing color: White Silver Black  
 Color temperature: 2700K 3000K 4000K  
 Beam angle: 15° 24° 36°

Driver gear for LED: Non-Dimmable  
 1-10V Dimmable  
 Triac Dimmable

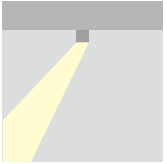

- Luminaire housing: Pure aluminum.
- Ceiling mouted plate: Steel sheet.
- The spot light tilts to a maximum of 0°-25° onto the vertical plane and rotates by 358° onto the horizontal plane.
- Light source: COB LED with a lens of optical.

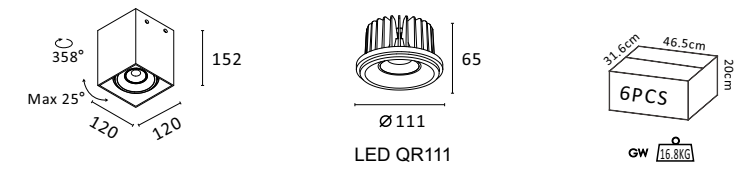

**C6002 15W 1670lm**  
 With LED Driver 36V-350mA  
 230V-50Hz

NW  
 1.20kg

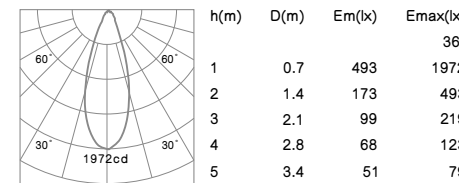
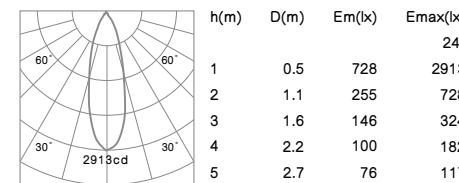
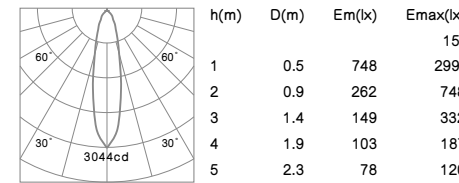

**C6003 20W 2280lm**  
 With LED Driver 36V-500mA  
 230V-50Hz

NW  
 1.20kg

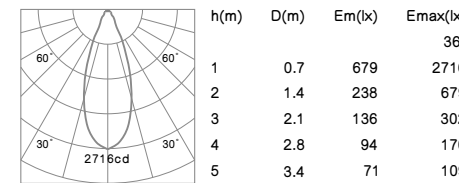
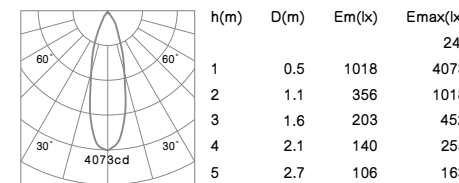
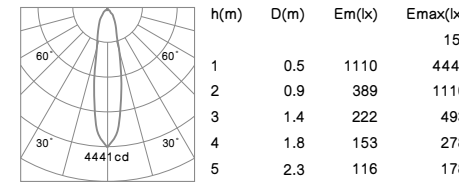

**TODO** Pendant



**LED QR111 CRI≥80 IP20 CE RoHS**

Housing color: White Silver Black  
 Color temperature: 2700K 3000K 4000K  
 Beam angle: 15° 24° 36°

Driver gear for LED: Non-Dimmable  
 1-10V Dimmable  
 Triac Dimmable

- Luminaire housing: Pure aluminum.
- Ceiling mounted plate: Steel sheet.
- The spot light tilts to a maximum of 0°-25° onto the vertical and rotates by 358° onto the horizontal plane.
- Light source: COB LED with a lens of optical.

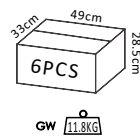
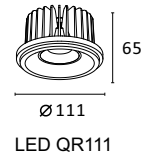
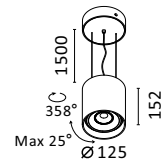

GW 11.8KG

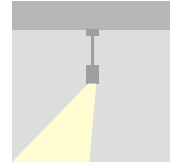

**P6004 15W 1670lm**  
 With LED Driver 36V-350mA  
 230V-50Hz

NW  
 1.61kg

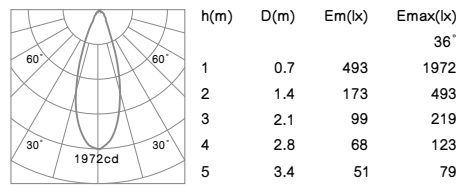
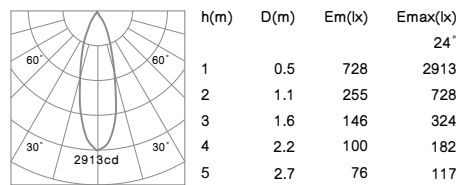
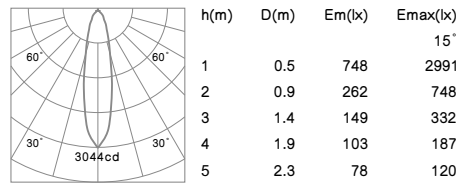

**P6005 20W 2000lm**  
 With LED Driver 36V-500mA  
 230V-50Hz

NW  
 1.61kg

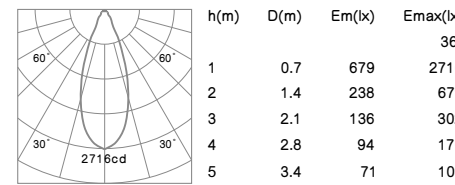
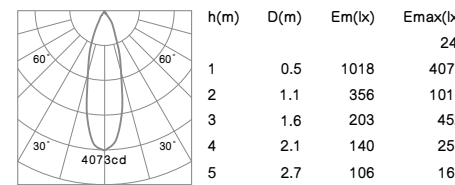
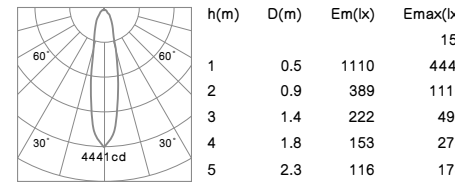

**TODO** Pendant



**LED QR111 CRI≥80 IP20 CE RoHS**

Housing color: White Silver Black  
 Color temperature: 2700K 3000K 4000K  
 Beam angle: 15° 24° 36°

Driver gear for LED: Non-Dimmable  
 1-10V Dimmable  
 Triac Dimmable

- Luminaire housing: Pure aluminum.
- Ceiling mounted plate: Steel sheet.
- The spot light tilts to a maximum of 0°-25° onto the vertical and rotates by 358° onto the horizontal plane.
- Light source: COB LED with a lens of optical.

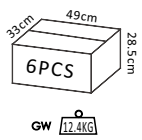
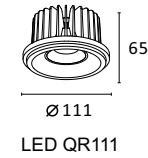
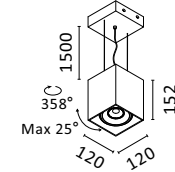

GW 12.4KG

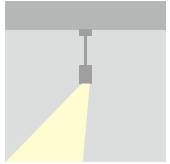

**P6002 15W 1670lm**  
 With LED Driver 36V-350mA  
 230V-50Hz

NW  
 1.63kg

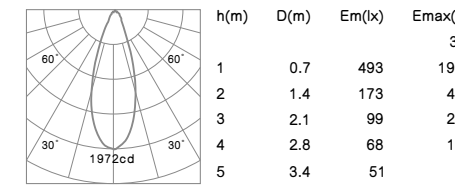
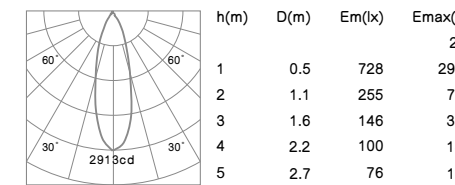
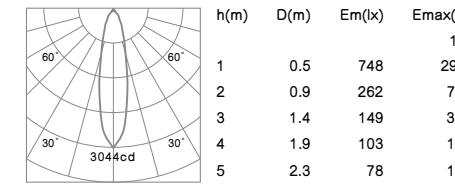

**P6003 20W 2000lm**  
 With LED Driver 36V-500mA  
 230V-50Hz

NW  
 1.63kg

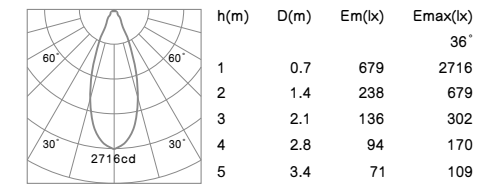
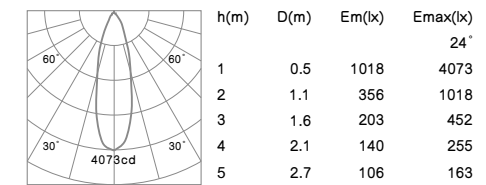
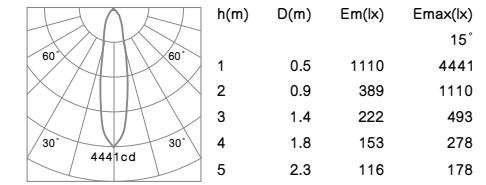

PEDA



BB(black)



BW(white)



BPS(pearls silver)



PEDA

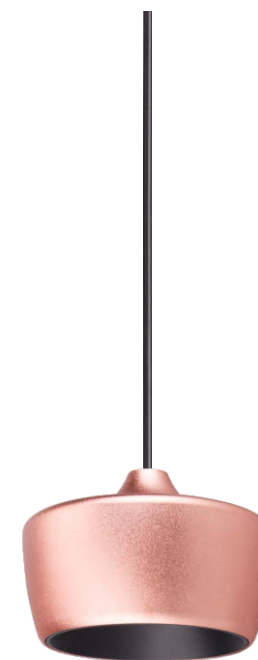

BRG(rose gold)



BAB(antique-brass)



BCG(champaign gold)





PEDA



391

PEDA



392



# PEDA



Ø 70mm 6W

P394



Ø 65mm 6W

P395



Ø 74mm 6W

P396



Ø 72mm 6W

P397



Ø 66mm 6W

P398

# PEDA



**COB LED** **CRI≥80** **IP20** **CE** **RoHS**

Housing color:  BW  BB  BPS  BAB  BRG  BCG

Color temperature: 2700K 3000K 4000K  
Beam angle: 10° 20° 30°

Driver gear for LED: Non-Dimmable

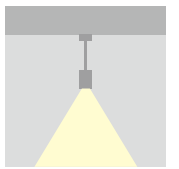

- Luminaire housing: Pure aluminum.
- Ceiling mounted plate: Steel sheet.
- Light source: COB LED with a high efficiency reflector of optical.
- Accessories: Anti-Glare Snoot and honey comb is optional.
- UGR<19.
- Color: Pearls Silver, Antique-Brass, Rose Gold, Champaign Gold.

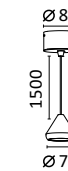

COB LED

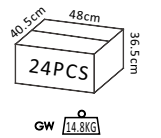

**P6022 6W 590lm**  
With LED Driver 36V-150mA  
230V-50Hz

NW  
0.50kg

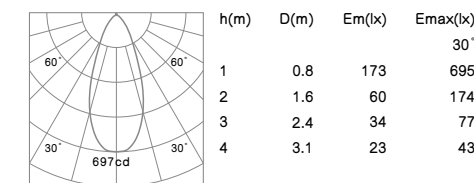
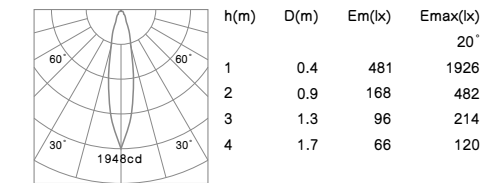
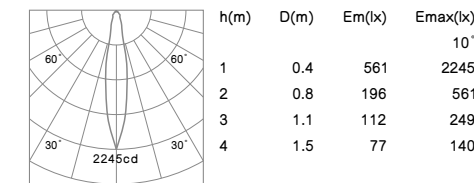

**Optical Accessories :**



**03142**  
Honey comb for above COB LED pendent lights.



**15034**  
Snoot for above COB LED pendent lights.



# PEDA



**COB LED CRI≥80 IP20 CE RoHS**

Housing color:      
 BW BB BPS BAB BRG BCG

Color temperature: 2700K 3000K 4000K  
 Beam angle: 10° 20° 30°

Driver gear for LED: Non-Dimmable

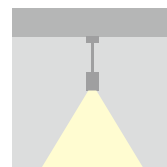

- Luminaire housing: Pure aluminum.
- Ceiling mounted plate: Steel sheet.
- Light source: COB LED with a high efficiency reflector of optical.
- Accessories: Anti-Glare Snoot and honey comb is optional.
- UGR<19.
- Color: Pearls Silver, Antique-Brass, Rose Gold, Champaign Gold.

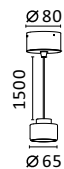

COB LED

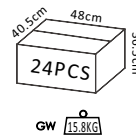

GW 15.8KG

**P6023 6W 590lm**  
 With LED Driver 36V-150mA  
 230V-50Hz

NW  
 0.54kg

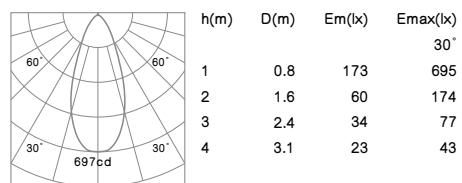
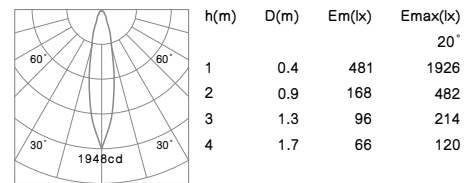
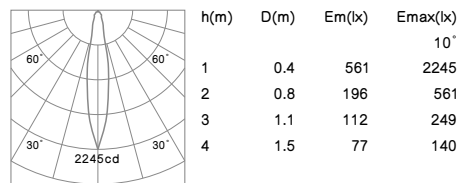

**Optical Accessories :**



**03142**  
 Honey comb for above COB LED pendent lights.



**15034**  
 Snoot for above COB LED pendent lights.

# PEDA



**COB LED CRI≥80 IP20 CE RoHS**

Housing color:      
 BW BB BPS BAB BRG BCG

Color temperature: 2700K 3000K 4000K  
 Beam angle: 10° 20° 30°

Driver gear for LED: Non-Dimmable

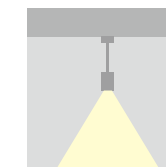

- Luminaire housing: Pure aluminum.
- Ceiling mounted plate: Steel sheet.
- Light source: COB LED with a high efficiency reflector of optical.
- Accessories: Anti-Glare Snoot and honey comb is optional.
- UGR<19.
- Color: Pearls Silver, Antique-Brass, Rose Gold, Champaign Gold.

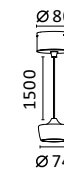

COB LED

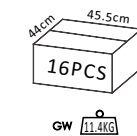

GW 11.4KG

**P6024 6W 590lm**  
 With LED Driver 36V-150mA  
 230V-50Hz

NW  
 0.56kg

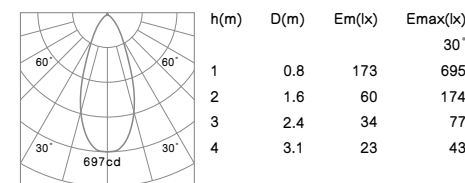
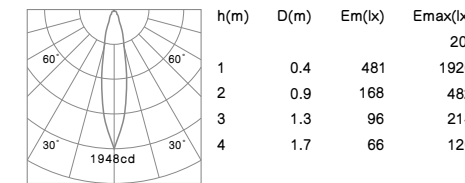
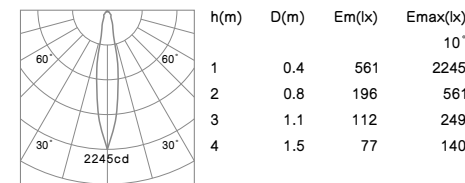

**Optical Accessories :**



**03142**  
 Honey comb for above COB LED pendent lights.



**15034**  
 Snoot for above COB LED pendent lights.

# PEDA



**COB LED CRI≥80 IP20 CE RoHS**

Housing color:

BW BB BPS BAB BRG BCG

Color temperature: 2700K 3000K 4000K

Beam angle: 10° 20° 30°

Driver gear for LED: Non-Dimmable

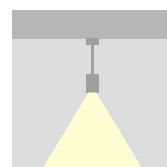

- Luminaire housing: Pure aluminum.
- Ceiling mounted plate: Steel sheet.
- Light source: COB LED with a high efficiency reflector of optical.
- Accessories: Anti-Glare Snoot and honey comb is optional.
- UGR<19.
- Color: Pearls Silver, Antique-Brass, Rose Gold, Champaign Gold.

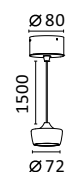

COB LED

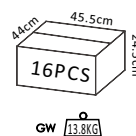

**P6025 6W 590lm**  
With LED Driver 36V-150mA  
230V-50Hz

NW  
0.71kg

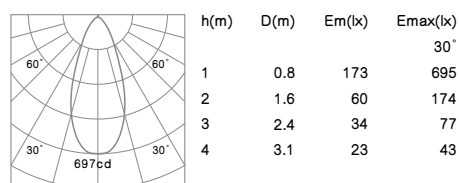
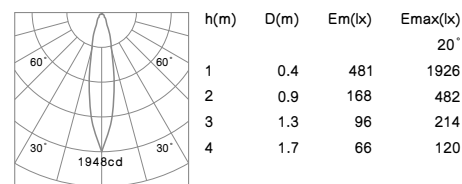
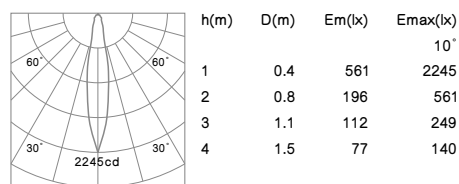

## Optical Accessories :



**03142**  
Honey comb for above COB LED pendent lights.



**15034**  
Snoot for above COB LED pendent lights.

# PEDA



**COB LED CRI≥80 IP20 CE RoHS**

Housing color:

BW BB BPS BAB BRG BCG

Color temperature: 2700K 3000K 4000K

Beam angle: 10° 20° 30°

Driver gear for LED: Non-Dimmable

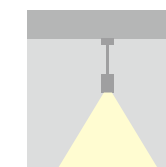

- Luminaire housing: Pure aluminum.
- Ceiling mounted plate: Steel sheet.
- Light source: COB LED with a high efficiency reflector of optical.
- Accessories: Anti-Glare Snoot and honey comb is optional.
- UGR<19.
- Color: Pearls Silver, Antique-Brass, Rose Gold, Champaign Gold.

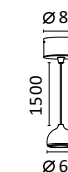

COB LED

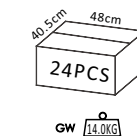

**P6026 6W 590lm**  
With LED Driver 36V-150mA  
230V-50Hz

NW  
0.46kg

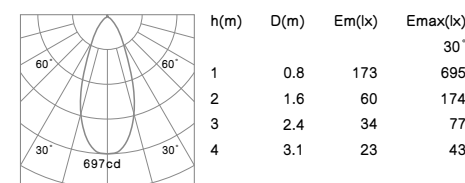
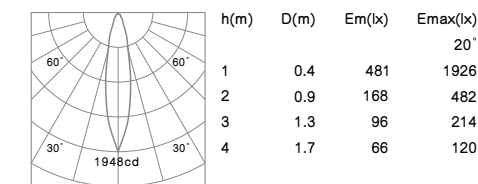
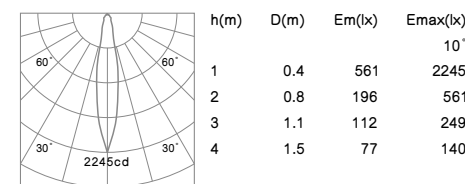

## Optical Accessories :



**03142**  
Honey comb for above COB LED pendent lights.



**15034**  
Snoot for above COB LED pendent lights.

LINA



399

LINA



400



LINA

LINA



401

402

# LINA

## Pendant



Ø 40x140mm 6W 10W P404

Ø 57x300mm 6W 10W P405

Ø 57x600mm 6W 10W P406

## Surface-mounted



Ø 57x300mm 6W 10W P407

Ø 57x300mm 6W 10W P408

Ø 57x600mm 6W 10W P409

Ø 57x600mm 6W 10W P410

# LINA

## Pendant



**COB LED CRI≥80 IP20 CE RoHS**

Housing color:  BW  BB  BPS  BAB  BRG  BCG

Color temperature: 2700K 3000K 4000K  
 Beam angle: 24° 36° 60°

Driver gear for LED: Non-Dimmable

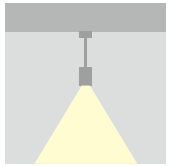

- Luminaire housing: Pure aluminum.
- Ceiling mouted plate: Steel sheet.
- Light source: COB LED with a lens of optical.

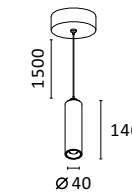

COB LED

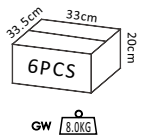

**P6016 6W 540lm**  
 With LED Driver 36V-150mA  
 230V-50Hz

NW  
 0.72kg

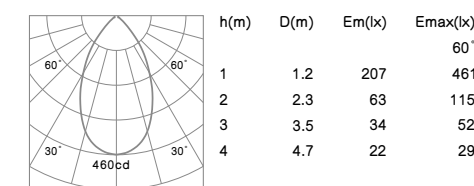
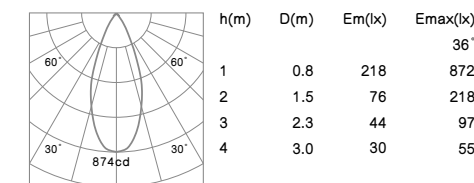
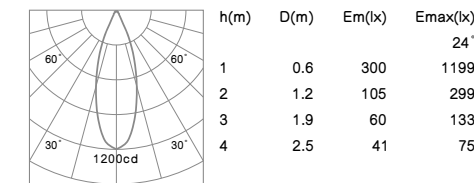

**P6016 10W 900lm**  
 With LED Driver 36V-250mA  
 230V-50Hz

NW  
 0.72kg

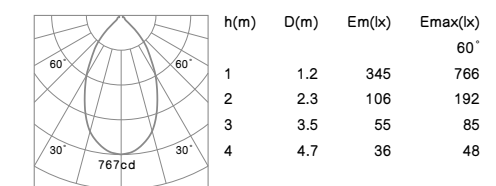
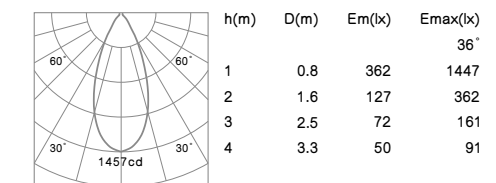
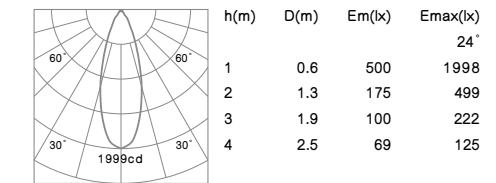

# LINA Pendant



**COB LED CRI≥80 IP20 CE RoHS**

Housing color:

Color temperature: 2700K 3000K 4000K  
Beam angle: 24° 36° 60°

Driver gear for LED: Non-Dimmable

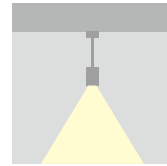

•Luminaire housing: Pure aluminum.  
•Light source: COB LED with a lens of optical.

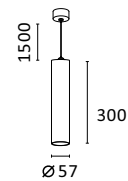

COB LED

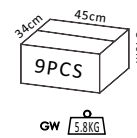

GW 5.8kg

**P6017 6W 650lm**  
With LED Driver 36V-150mA  
230V-50Hz

NW  
0.73kg

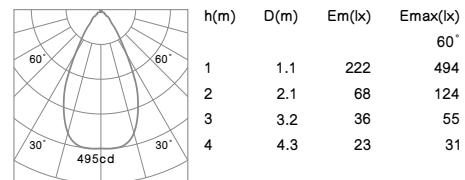
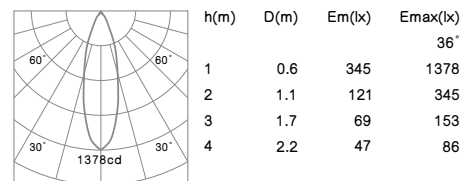
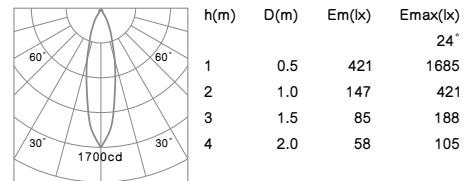

**P6017 10W 1150lm**  
With LED Driver 36V-250mA  
230V-50Hz

NW  
0.73kg

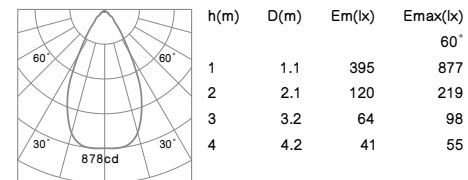
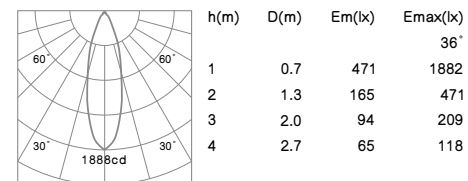
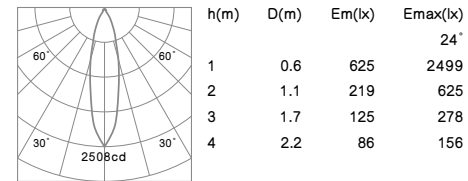

# LINA Pendant



**COB LED CRI≥80 IP20 CE RoHS**

Housing color:

Color temperature: 2700K 3000K 4000K  
Beam angle: 24° 36° 60°

Driver gear for LED: Non-Dimmable

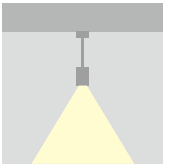

•Luminaire housing: Pure aluminum.  
•Light source: COB LED with a lens of optical.

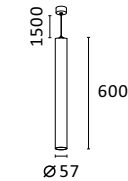

COB LED

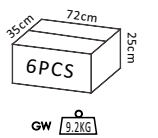

GW 5.2kg

**P6018 6W 650lm**  
With LED Driver 36V-150mA  
230V-50Hz

NW  
1.20kg

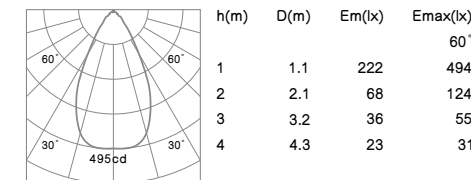
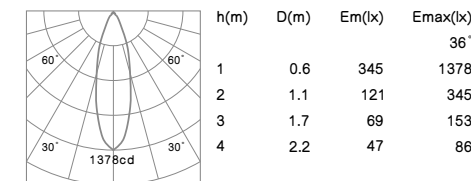
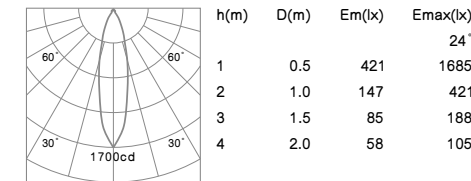

**P6018 10W 1150lm**  
With LED Driver 36V-250mA  
230V-50Hz

NW  
1.20kg

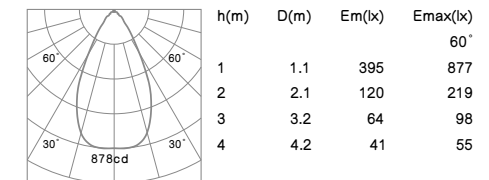
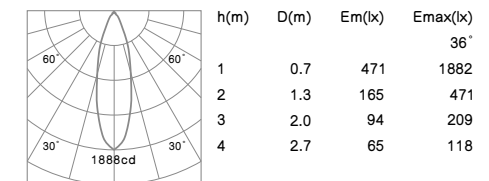
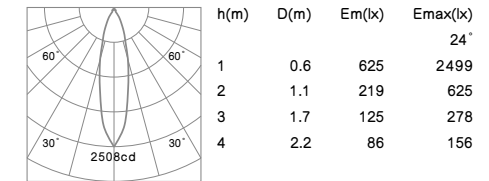



**LINA** Surface-mounted



**COB LED CRI≥80 IP20 CE RoHS**  
 Housing color: White Silver Black  
 Color temperature: 2700K 3000K 4000K  
 Beam angle: 24° 36° 60°

Driver gear for LED: Non-Dimmable

- Luminaire housing: Pure aluminum.
- Light source: COB LED with a lens of optical.

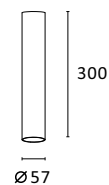
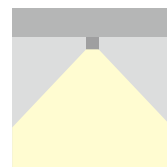

COB LED

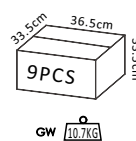

**C6032 6W 650lm**  
 With LED Driver 36V-135mA  
 230V-50Hz

NW  
 0.57kg

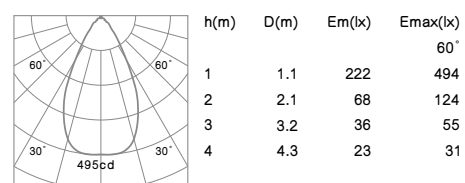
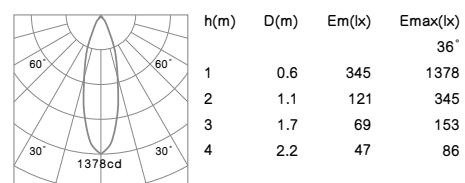
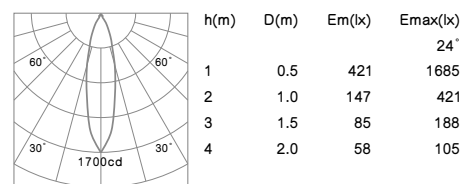

**C6032 10W 1150lm**  
 With LED Driver 36V-250mA  
 230V-50Hz

NW  
 0.57kg

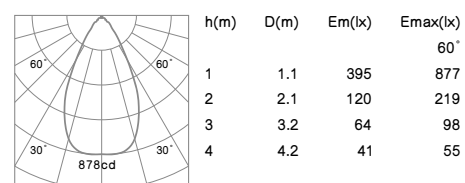
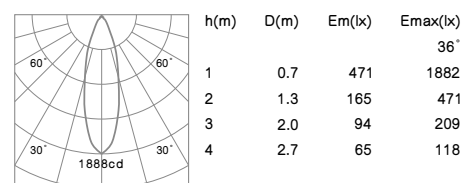
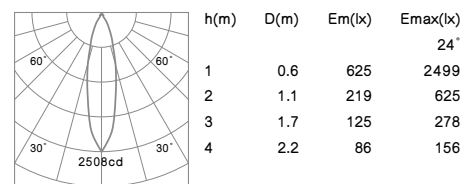

**LINA** Surface-mounted



**COB LED CRI≥80 IP20 CE RoHS**  
 Housing color: White Silver Black  
 Color temperature: 2700K 3000K 4000K  
 Beam angle: 24° 36° 60°

Driver gear for LED: Non-Dimmable

- Luminaire housing: Pure aluminum.
- Light source: COB LED with a lens of optical.

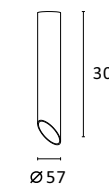
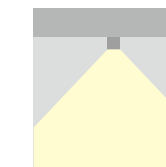

COB LED

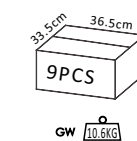

**C6031 6W 520lm**  
 With LED Driver 36V-135mA  
 230V-50Hz

NW  
 0.57kg

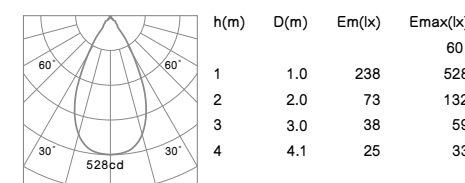
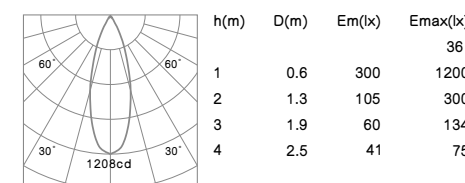
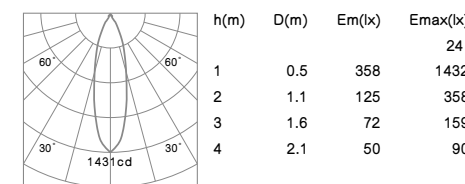

**C6031 10W 900lm**  
 With LED Driver 36V-250mA  
 230V-50Hz

NW  
 0.57kg

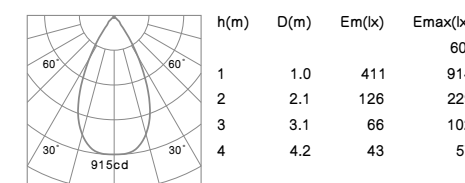
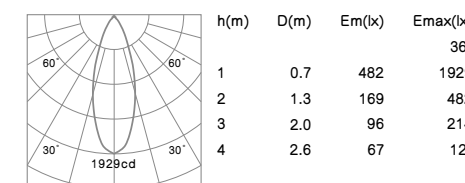
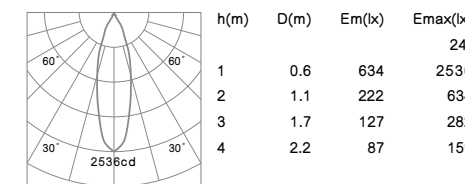



LINA Surface-mounted



**COB LED CRI≥80 IP20 CE RoHS**  
 Housing color: White Silver Black  
 Color temperature: 2700K 3000K 4000K  
 Beam angle: 24° 36° 60°

Driver gear for LED: Non-Dimmable

- Luminaire housing: Pure aluminum.
- Light source: COB LED with a lens of optical.

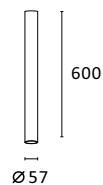
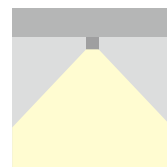

COB LED

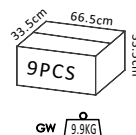

**C6030 6W 650lm**  
 With LED Driver 36V-135mA  
 230V-50Hz

NW  
 0.99kg

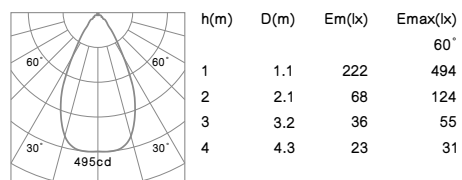
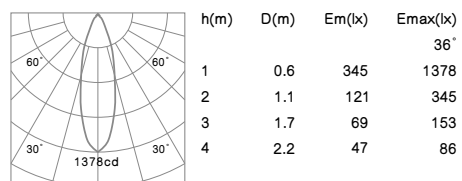
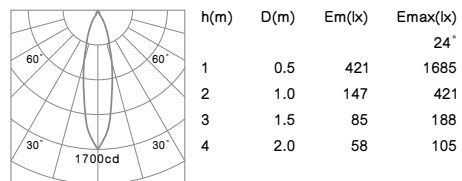

**C6030 10W 1150lm**  
 With LED Driver 36V-250mA  
 230V-50Hz

NW  
 0.99kg

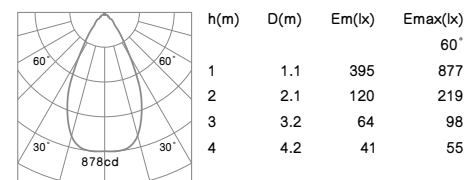
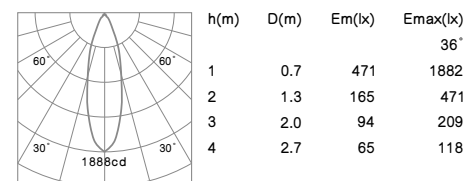
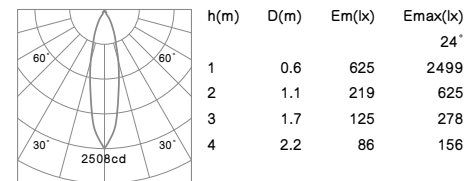

LINA Surface-mounted



**COB LED CRI≥80 IP20 CE RoHS**  
 Housing color: White Silver Black  
 Color temperature: 2700K 3000K 4000K  
 Beam angle: 24° 36° 60°

Driver gear for LED: Non-Dimmable

- Luminaire housing: Pure aluminum.
- Light source: COB LED with a lens of optical.

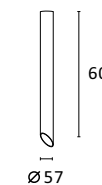
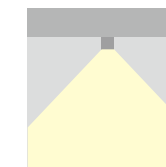

COB LED

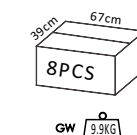

**C6029 6W 520lm**  
 With LED Driver 36V-150mA  
 230V-50Hz

NW  
 0.98kg

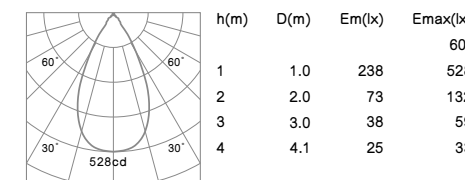
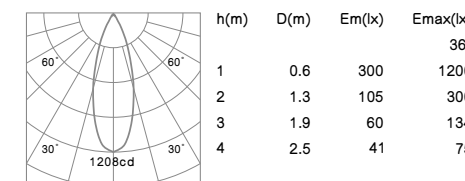
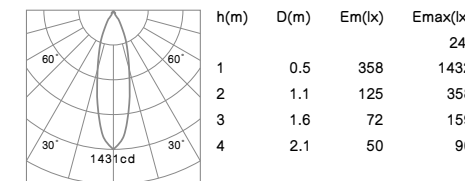

**C6029 10W 900lm**  
 With LED Driver 36V-250mA  
 230V-50Hz

NW  
 0.98kg

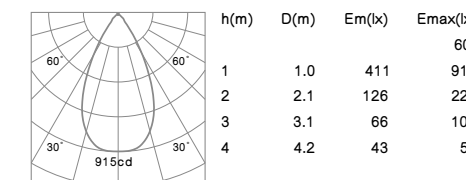
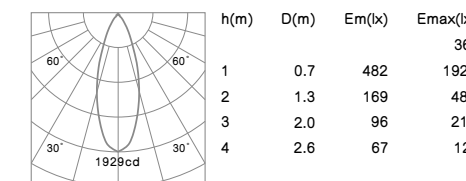
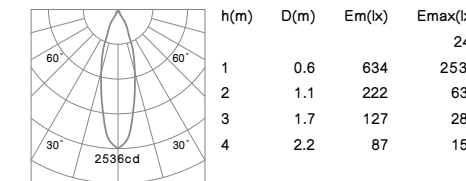

DACU



BCG(champaign gold)



BAB(antique-brass)



BRG(rose gold)



411

DACU



BAB(antique-brass)



BRG(rose gold)



BRG(rose gold)



BAB(antique-brass)



BCG(champaign gold)



BCG(champaign gold)



412

DACU



• COB LED  
Lens of Optical  
10W  
24° 36° 45°

413

DACU



414

DACU



415

DACU



Ø 200x220mm 10W P418



Ø 200x220mm 10W P419



Ø 200x300mm 10W P420

416



# DACU



Ø 55x250mm 10W P421



Ø 60x280mm 10W P422

# DACU



P6033 10W 750lm  
With LED Driver 36V-250mA  
230V-50Hz

NW  
0.77kg

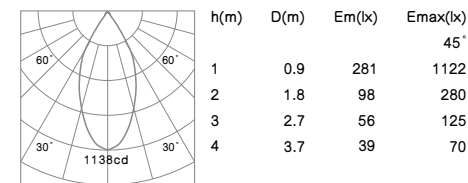
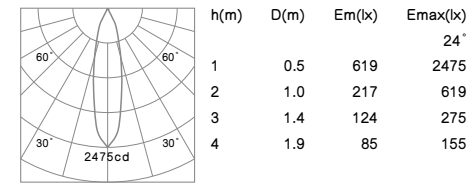

COB LED CRI≥80 IP20 CE RoHS

Lamp shade color: BW BB BAB BRG BCG

Color temperature: 2700K 3000K 4000K  
Beam angle: 24° 36° 45°

Driver gear for LED: Non-Dimmable

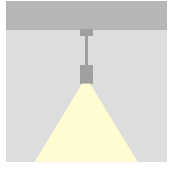

- Luminaire housing: Pure aluminum.
- Ceiling mounted plate: Steel sheet.
- Light source: COB LED with a high transmittance acrylic len.
- UGR<19.
- Color: White, Black, Antique-Brass, Rose Gold, Champaign Gold.

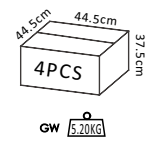
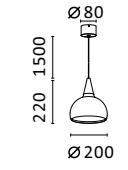

# DACU



**COB LED CRI≥80 IP20 CE RoHS**

Lamp shade color:       
 BW BB BAB BRG BCG

Color temperature: 2700K 3000K 4000K  
 Beam angle: 24° 36° 45°

Driver gear for LED: Non-Dimmable

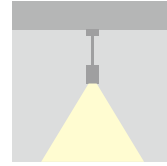

- Luminaire housing: Pure aluminum.
- Ceiling mounted plate: Steel sheet.
- Light source: COB LED with a high transmittance acrylic len.
- UGR<19.
- Color: White, Black, Antique-Brass, Rose Gold, Champaign Gold.

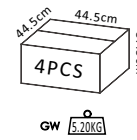

**P6034 10W 750lm**  
 With LED Driver 36V-250mA  
 230V-50Hz

NW  
 0.77kg

h(m)	D(m)	Em(lx)	E <sub>max</sub> (lx)
1	0.5	617	2466
2	0.9	216	616
3	1.4	123	274
4	1.9	85	154

h(m)	D(m)	Em(lx)	E <sub>max</sub> (lx)
1	0.7	349	1395
2	1.4	122	349
3	2.1	70	155
4	2.8	48	87

h(m)	D(m)	Em(lx)	E <sub>max</sub> (lx)
1	0.9	285	1141
2	1.8	100	285
3	2.8	57	127
4	3.7	39	71

# DACU



**COB LED CRI≥80 IP20 CE RoHS**

Lamp shade color:       
 BW BB BAB BRG BCG

Color temperature: 2700K 3000K 4000K  
 Beam angle: 24° 36° 45°

Driver gear for LED: Non-Dimmable

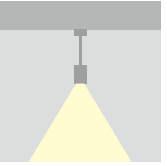

- Luminaire housing: Pure aluminum.
- Ceiling mounted plate: Steel sheet.
- Light source: COB LED with a high transmittance acrylic len.
- UGR<19.
- Color: White, Black, Antique-Brass, Rose Gold, Champaign Gold.

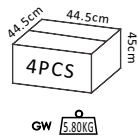
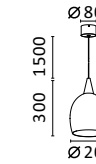

**P6035 10W 700lm**  
 With LED Driver 36V-250mA  
 230V-50Hz

NW  
 0.88kg

h(m)	D(m)	Em(lx)	E <sub>max</sub> (lx)
1	0.5	618	2472
2	0.9	216	618
3	1.4	124	275
4	1.9	85	155

h(m)	D(m)	Em(lx)	E <sub>max</sub> (lx)
1	0.7	346	1382
2	1.4	121	346
3	2.1	69	154
4	2.8	47	86

h(m)	D(m)	Em(lx)	E <sub>max</sub> (lx)
1	0.8	282	1126
2	1.6	98	281
3	2.4	56	125
4	3.3	39	70

# DACU



**COB LED CRI≥80 IP20 CE RoHS**

Lamp shade color:       
 BW BB BAB BRG BCG

Color temperature: 2700K 3000K 4000K  
 Beam angle: 24° 36° 60°

Driver gear for LED: Non-Dimmable

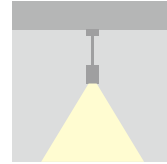

- Luminaire housing: Pure aluminum.
- Ceiling mounted plate: Steel sheet.
- Light source: COB LED with a high transmittance acrylic optical accessory.
- Color: White, Black, Antique-Brass, Rose Gold, Champaign Gold.

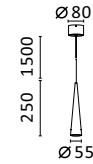

COB LED

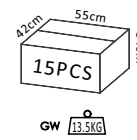

**P6040 6W 545lm**  
 With LED Driver 36V-150mA  
 230V-50Hz

NW  
 0.78kg

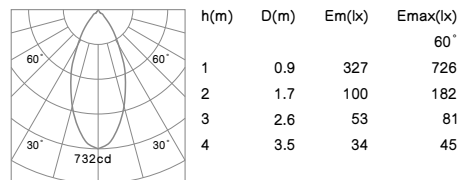
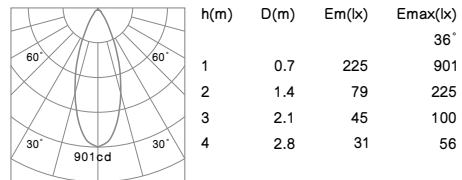
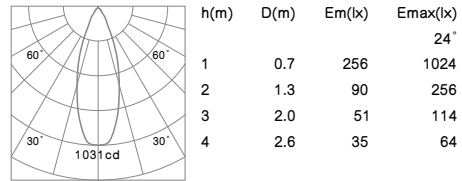

**P6040 10W 938lm**  
 With LED Driver 36V-250mA  
 230V-50Hz

NW  
 0.78kg

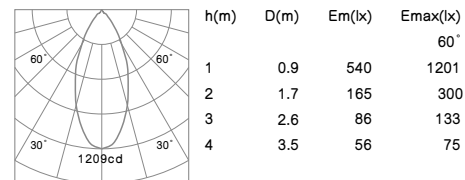
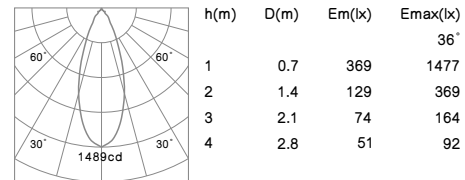
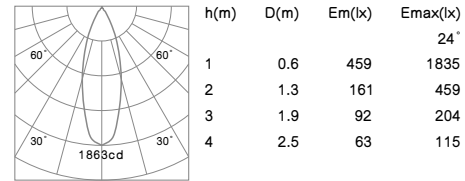

# DACU

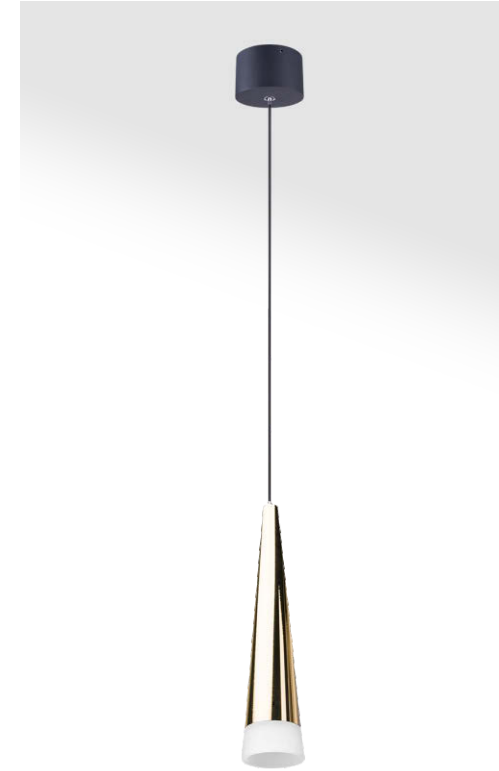

**COB LED CRI≥80 IP20 CE RoHS**

Lamp shade color:       
 BW BB BAB BRG BCG

Color temperature: 2700K 3000K 4000K  
 Beam angle: 24° 36° 60°

Driver gear for LED: Non-Dimmable

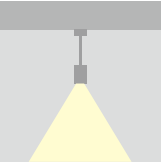

- Luminaire housing: Pure aluminum.
- Ceiling mounted plate: Steel sheet.
- Light source: COB LED with a high transmittance acrylic optical accessory.
- Color: White, Black, Antique-Brass, Rose Gold, Champaign Gold.

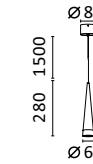

COB LED

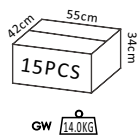

**P6041 6W 553lm**  
 With LED Driver 36V-150mA  
 230V-50Hz

NW  
 0.81kg

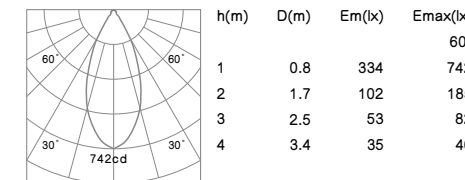
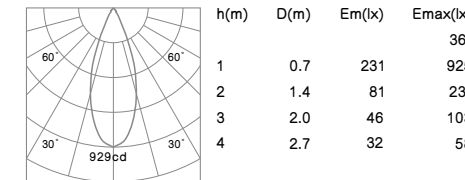
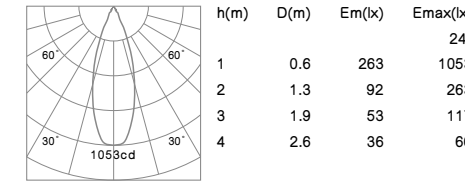

**P6041 10W 953lm**  
 With LED Driver 36V-250mA  
 230V-50Hz

NW  
 0.81kg

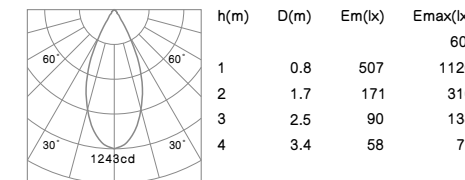
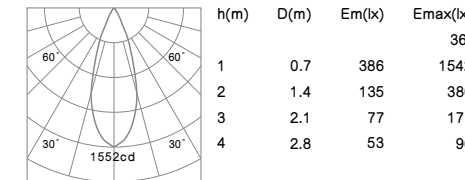
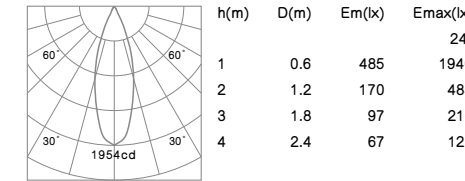

SOPO



423

SOPO



424



SOPO



RS



RL

SOPO



MS



ML



Single



Double

425



Triple

426

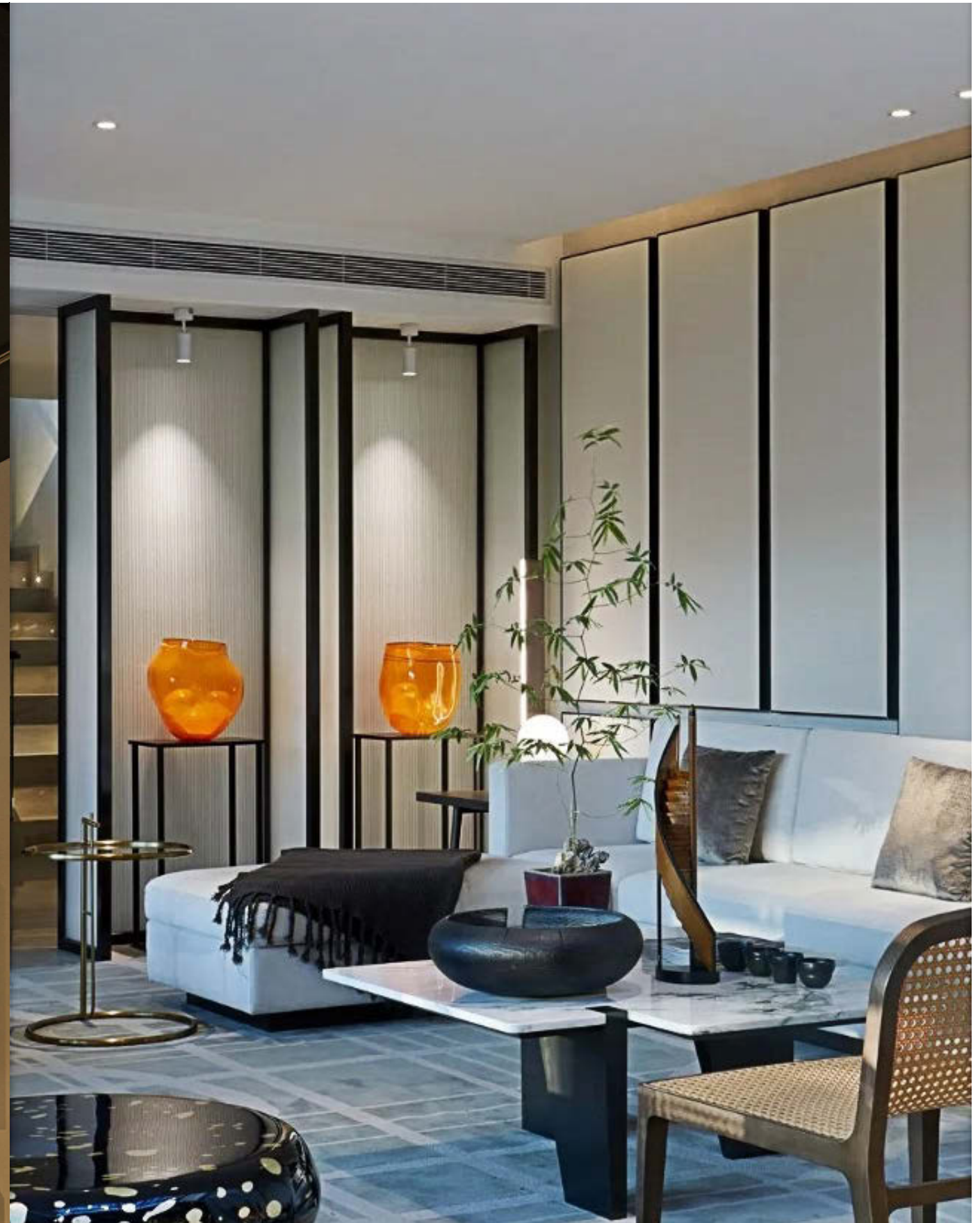



SOPO



429

SOPO









430



# SOPO

## Track Spot Light

	S	Ø 70x78mm	6W 10W 15W	P435
	M	Ø 70x115mm	10W 15W	P437
	L	Ø 100x145mm	25W 30W 40W	P439
	M	Ø 90x134mm	15W 20W 25W	P441
	M	Ø 90x154mm	15W 20W 25W	P443
	L	Ø 125x155mm	20W 25W 30W 40W	P445
	L	Ø 125x175mm	20W 25W 30W 40W	P448

# SOPO

## Track Accessories



Surface mounted Track

P453

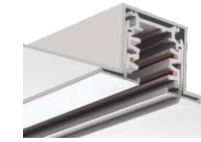

Recessed Track

P454



# SOPO

## Surface-mounted Spot Light



MS    Ø 70x115mm    10W 15W    P457



MD    Ø 70x115mm    2x10W 2x15W    P459



MT    Ø 70x115mm    3x10W 3x15W    P461



S    Ø 68x90mm    6W 10W    P463



S    Ø 70x78mm    10W 15W    P465



M    Ø 90x134mm    15W 20W 25W    P467



L    Ø 125x155mm    25W 30W 40W    P469

# SOPO

## Recessed Spot Light



M    Ø 90x134mm    15W 20W 25W    P471



M    Ø 90x155mm    15W 20W 25W    P473



L    Ø 125x155mm    20W 25W 30W 40W    P475



L    Ø 125x175mm    20W 25W 30W 40W    P478

# Track Spot Light s



**COB LED CRI≥80 IP20 CE RoHS**

Housing color: White Silver Black  
 Color temperature: 2700K 3000K 4000K  
 Beam angle: 15° 24° 36° 60°

Driver gear for LED:  
 Non-Dimmable  
 1-10V Dimmable  
 DALI Dimmable  
 Triac Dimmable

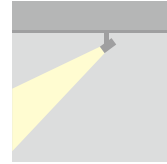

- Luminaire housing: Cast aluminum.
- The driver is built in the plastic track box, which with the track base compartment secure to the adaptor and installation on main voltage 3-circuit track system.
- Spot light adjustable 358° rotating around the vertical axis and 90° rotating around the horizontal axis.
- Light source: COB LED with a high efficiency reflector of optical.

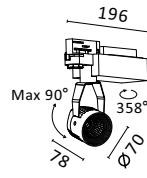

COB LED

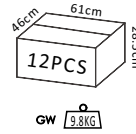

**T6012 6W 550lm**  
 With LED Driver 36V-135mA  
 230V-50Hz

NW  
 0.53kg

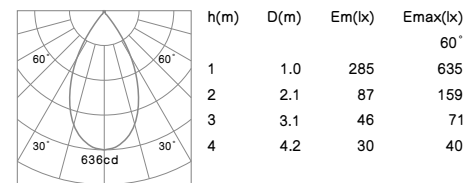
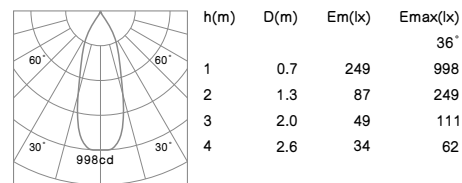
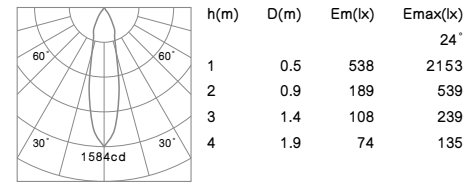
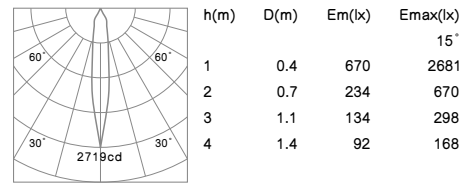

# Track Spot Light s

**T6012 10W 1050lm**  
 With LED Driver 36V-250mA  
 230V-50Hz

NW  
 0.53kg

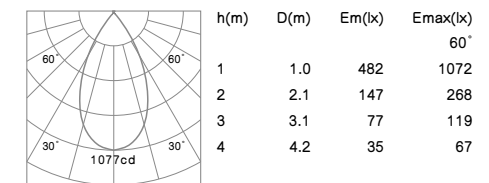
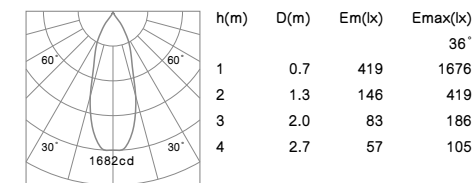
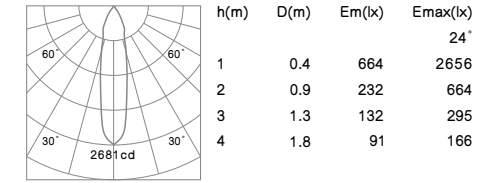
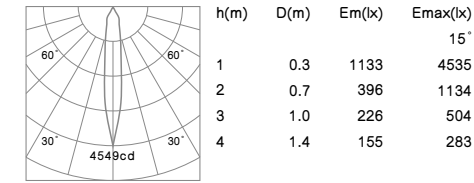

**T6012 15W 1370lm**  
 With LED Driver 36V-350mA  
 230V-50Hz

NW  
 0.53kg

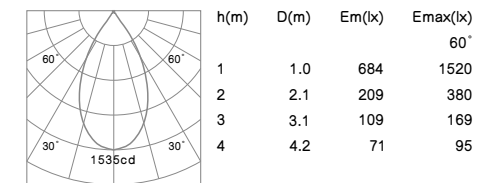
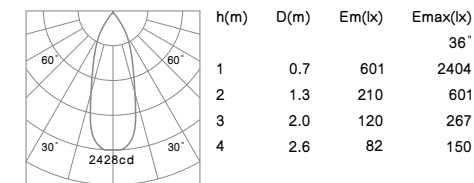
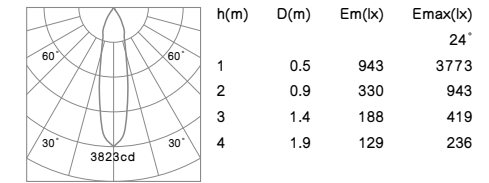
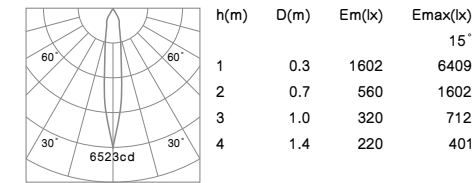

# Track Spot Light M



**COB LED CRI≥80 IP20 CE RoHS**

Housing color: White Silver Black  
 Color temperature: 2700K 3000K 4000K  
 Beam angle: 15° 24° 36° 60°

Driver gear for LED: Non-Dimmable

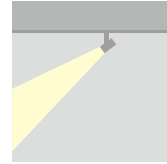

- Housing: Pure aluminum.
- Adjustable spot light, the driver is built in the light body, with the track base compartment secure to the adaptor and installation on main voltage 3-circuit track system.
- Spot light adjustable 358° rotating around the vertical axis and 90° rotating around the horizontal axis.
- Light source: COB LED with a high efficiency reflector of optical.

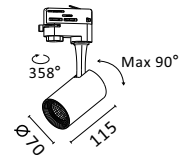

COB LED

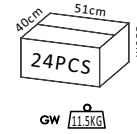

## T6017 10W 1040lm With LED Driver 36V-250mA 230V-50Hz

NW  
0.47kg

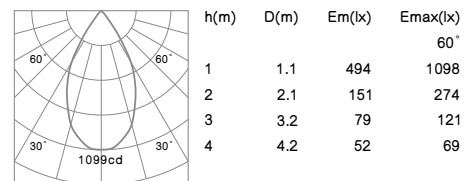
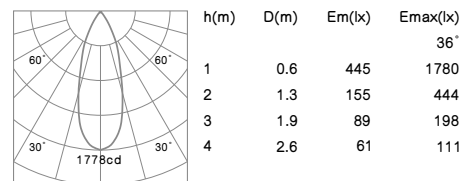
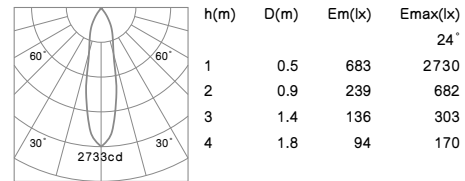
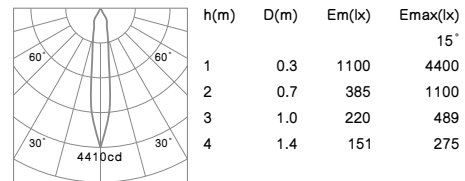

# Track Spot Light M

## T6017 15W 1350lm With LED Driver 36V-350mA 230V-50Hz

NW  
0.47kg

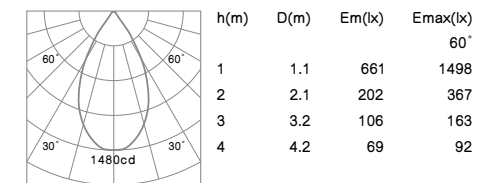
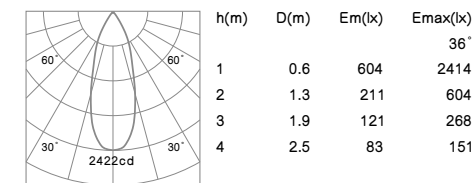
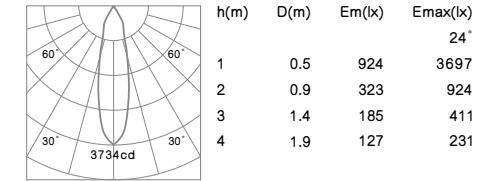
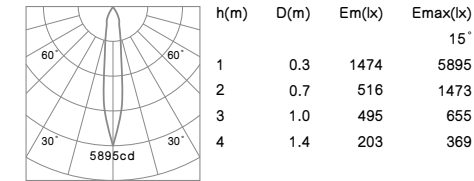

# Track Spot Light L



**COB LED CRI≥80 IP20 CE RoHS**  
 Housing color: White Silver Black  
 Color temperature: 2700K 3000K 4000K  
 Beam angle: 10° 20° 30°

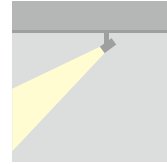

Driver gear for LED:  
 Non-Dimmable  
 1-10V Dimmable  
 DALI Dimmable  
 Triac Dimmable

- Housing: Pure aluminum.
- The driver is built in the plastic track box, which with the track base compartment secure to the adaptor and installation on main voltage 3-circuit track system.
- Spot light adjustable 358° rotating around the vertical axis and 90° rotating around the horizontal axis.
- Anti-dazzle ring: Aluminum black.
- Light source: COB LED with a lens of optical.

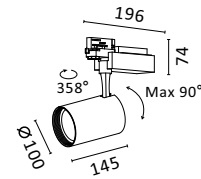

COB LED

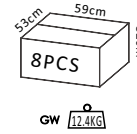

## T6099 25W 2240lm With LED Driver 36V-600mA 230V-50Hz

NW  
1.23kg

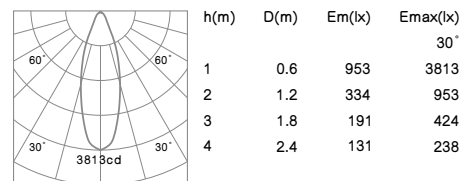
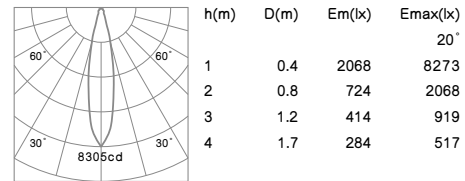
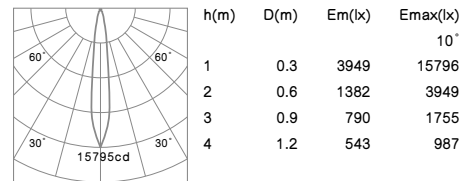

# Track Spot Light L

## T6099 30W 2850lm With LED Driver 36V-800mA 230V-50Hz

NW  
1.23kg

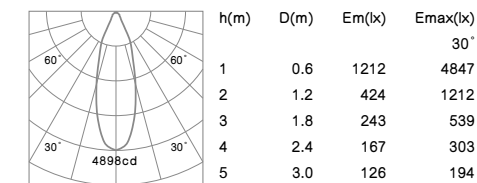
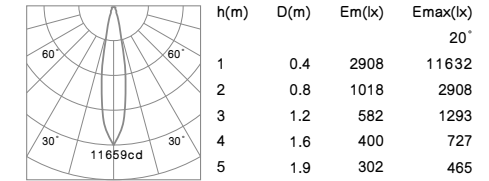
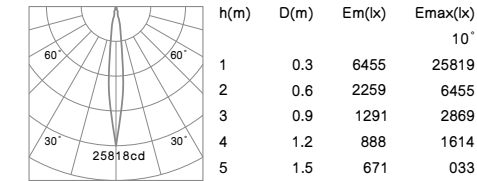

## T6099 40W 3450lm With LED Driver 36V-1050mA 230V-50Hz

NW  
1.23kg

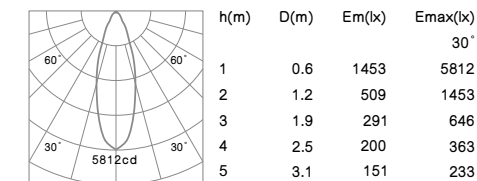
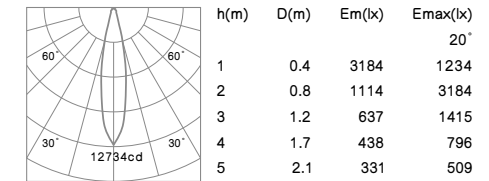
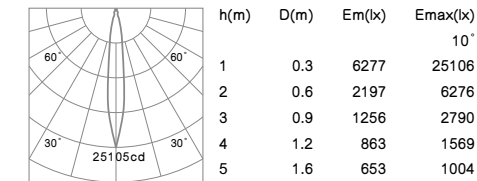



# Track Spot Light M



**COB LED CRI≥80 IP20 CE RoHS**  
 Housing color: White Silver Black  
 Color temperature: 2700K 3000K 4000K  
 Beam angle: 15° 24° 36° 60°

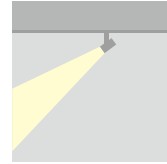

Driver gear for LED:  
 Non-Dimmable  
 1-10V Dimmable  
 DALI Dimmable  
 Triac Dimmable

- Housing and bracket: Cast aluminum.
- Adjustable spot light with a plastic LED driver housing compartment secure to the adaptor and installation on main voltage 3-circuit track system.
- Spot light adjustable 358° rotating around the vertical axis and 90° rotating around the horizontal axis.
- Anti-dazzle ring: Plastic black.
- Light spot pipe is available, which could make the light more soft and more perfect.
- Light source: COB LED with a high efficiency reflector of optical.

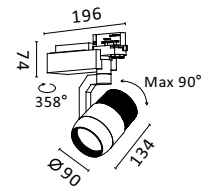

COB LED

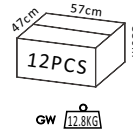

GW 12.8KG

## T6001 15W 1450lm With LED Driver 36V-350mA 230V-50Hz

NW  
0.90kg

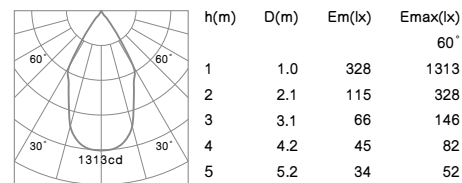
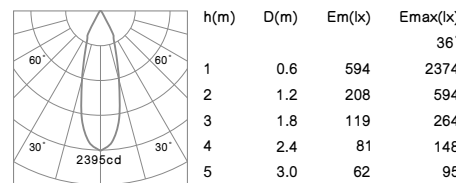
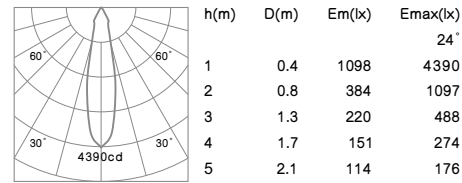
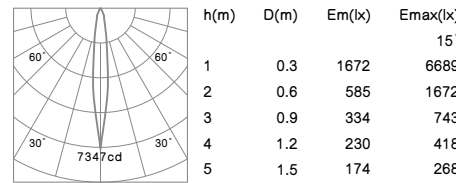

# Track Spot Light M

## T6001 20W 2000lm With LED Driver 36V-500mA 230V-50Hz

NW  
0.90kg

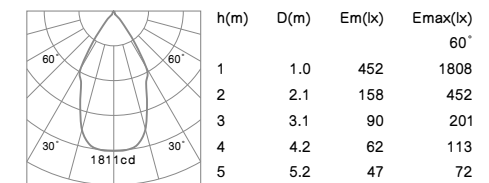
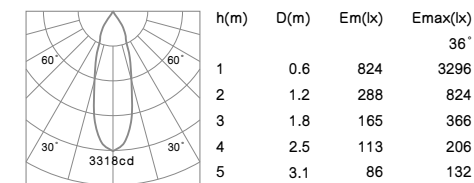
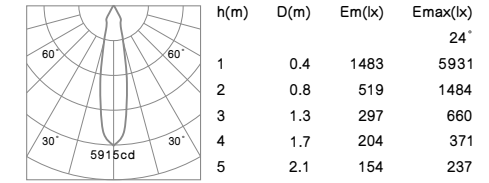
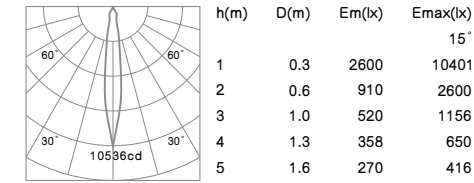

## T6001 25W 2250lm With LED Driver 36V-600mA 230V-50Hz

NW  
0.90kg

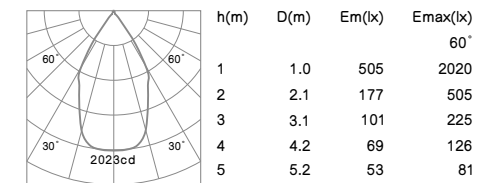
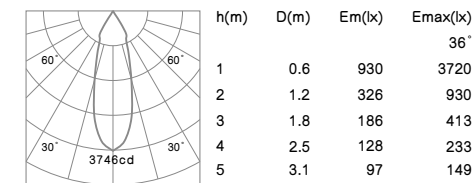
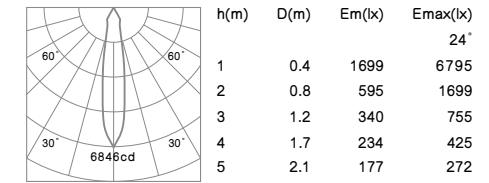
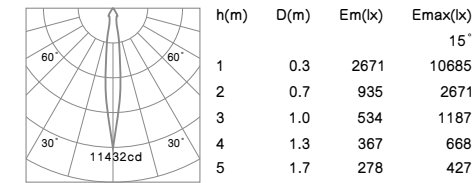

# Track Spot Light M



**COB LED CRI≥80 IP20 CE RoHS**

Housing color: White Silver Black  
 Color temperature: 2700K 3000K 4000K  
 Beam angle: 15° 24° 36°

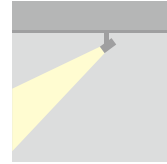

Driver gear for LED: Non-Dimmable  
 1-10V Dimmable  
 DALI Dimmable  
 Triac Dimmable

- Housing and bracket: Cast aluminum.
- Adjustable spot light with a plastic LED driver housing compartment secure to the adaptor and installation on main voltage 3-circuit track system.
- Spot light adjustable 358° rotating around the vertical axis and 90° rotating around the horizontal axis.
- Anti-dazzle ring: Plastic black.
- Light spot pipe is available, which could make the light more soft and more perfect.
- Light source: COB LED with a high efficiency reflector of optical.

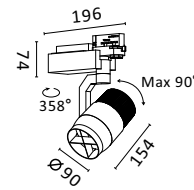

COB LED

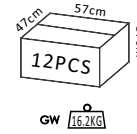

## T6032 15W 1040lm With LED Driver 36V-350mA 230V-50Hz

NW  
0.93kg

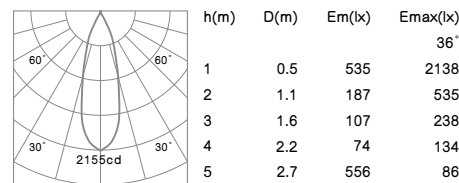
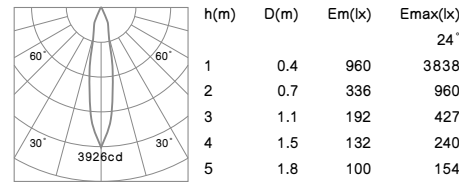
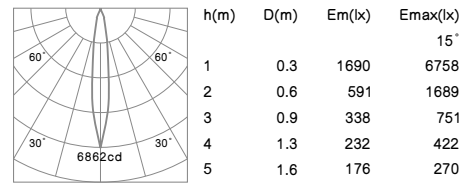

# Track Spot Light M

## T6032 20W 1430lm With LED Driver 36V-500mA 230V-50Hz

NW  
0.93kg

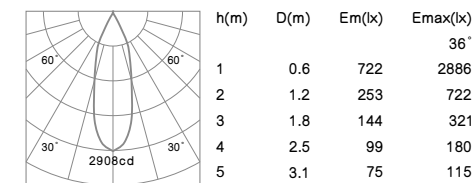
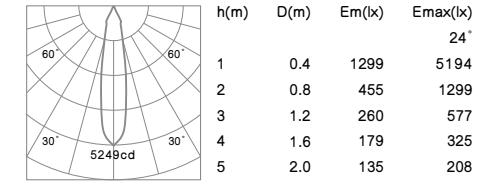
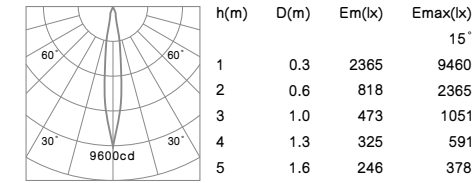

## T6032 25W 1620lm With LED Driver 36V-600mA 230V-50Hz

NW  
0.93kg

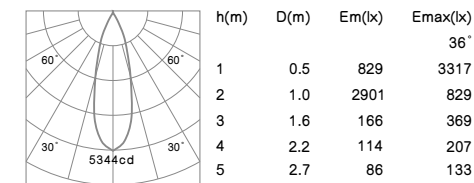
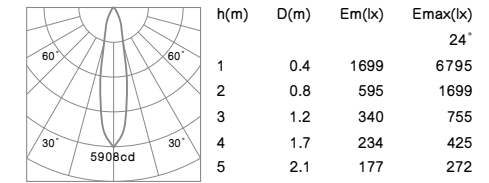
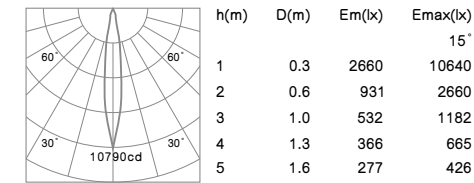

# Track Spot Light L



**COB LED CRI≥80 IP20 CE RoHS**

Housing color: White Silver Black  
 Color temperature: 2700K 3000K 4000K  
 Beam angle: 15° 24° 36° 60°

Driver gear for LED:  
 Non-Dimmable  
 1-10V Dimmable  
 DALI Dimmable  
 Triac Dimmable

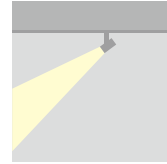

- Housing and bracket: Cast aluminum.
- Adjustable spot light with a plastic LED driver housing compartment secure to the adaptor and installation on main voltage 3-circuit track system.
- Spot light adjustable 358° rotating around the vertical axis and 90° rotating around the horizontal axis.
- Anti-dazzle ring: Plastic black.
- Light spot pipe is available, which could make the light more soft and more perfect.
- Light source: COB LED with a high efficiency reflector of optical.

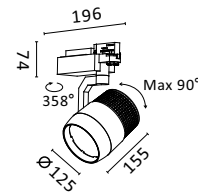

COB LED

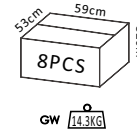

## T6002 20W 2040lm With LED Driver 36V-500mA 230V-50Hz

NW  
1.37kg

h(m)	D(m)	Em(lx)	Emax(lx)
1	0.3	3134	12537
2	0.6	1097	3134
3	0.9	627	1393
4	1.2	431	784
5	1.5	326	502

h(m)	D(m)	Em(lx)	Emax(lx)
1	0.4	2233	8933
2	0.7	782	2233
3	1.1	447	993
4	1.4	307	558
5	1.8	232	357

h(m)	D(m)	Em(lx)	Emax(lx)
1	0.6	844	3375
2	1.2	295	844
3	1.8	169	375
4	2.4	116	211
5	3.0	88	135

h(m)	D(m)	Em(lx)	Emax(lx)
1	0.9	526	2102
2	1.9	184	525
3	2.8	105	234
4	3.7	72	131
5	4.6	55	84

# Track Spot Light L

## T6002 25W 2350lm With LED Driver 36V-600mA 230V-50Hz

NW  
1.37kg

h(m)	D(m)	Em(lx)	Emax(lx)
1	0.3	3462	13847
2	0.6	1212	3462
3	0.9	693	1539
4	1.2	476	865
5	1.5	360	554

h(m)	D(m)	Em(lx)	Emax(lx)
1	0.4	2473	9892
2	0.7	866	2473
3	1.1	495	1099
4	1.4	340	618
5	1.8	257	396

h(m)	D(m)	Em(lx)	Emax(lx)
1	0.6	951	3905
2	1.3	333	951
3	1.9	190	423
4	2.5	131	238
5	3.2	99	152

h(m)	D(m)	Em(lx)	Emax(lx)
1	0.9	589	2357
2	1.9	206	589
3	2.8	118	262
4	3.7	81	147
5	4.7	61	94

## T6002 30W 3100lm With LED Driver 36V-800mA 230V-50Hz

NW  
1.37kg

h(m)	D(m)	Em(lx)	Emax(lx)
1	0.3	5167	20668
2	0.6	1808	5167
3	1.0	1034	2297
4	1.3	711	1292
5	1.6	538	828

h(m)	D(m)	Em(lx)	Emax(lx)
1	0.4	3400	13601
2	0.8	1190	3400
3	1.1	680	1511
4	1.5	468	850
5	1.9	354	544

h(m)	D(m)	Em(lx)	Emax(lx)
1	0.7	1381	5524
2	1.3	483	1381
3	2.0	276	614
4	2.6	190	345
5	3.3	144	221

h(m)	D(m)	Em(lx)	Emax(lx)
1	0.9	863	3452
2	1.9	302	863
3	2.8	173	384
4	3.8	119	216
5	4.7	90	138

# Track Spot Light L

**T6002 40W 4020lm**  
With LED Driver 36V-1050mA  
230V-50Hz

NW  
1.37kg

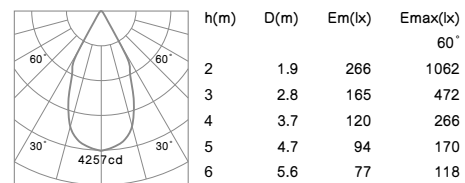
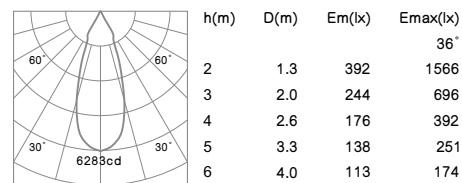
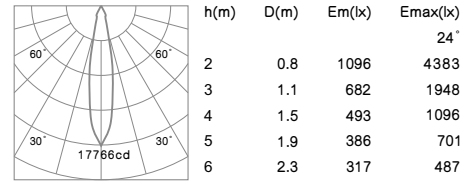
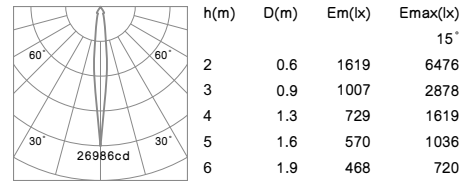

# Track Spot Light L

**COB LED CRI≥80 IP20 CE RoHS**

Housing color: White Silver Black  
Color temperature: 2700K 3000K 4000K  
Beam angle: 15° 24° 36°

Driver gear for LED: Non-Dimmable  
1-10V Dimmable  
DALI Dimmable  
Triac Dimmable

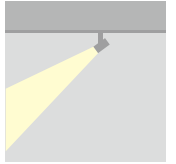

- Housing and bracket: Cast aluminum.
- Adjustable spot light with a plastic LED driver housing compartment secure to the adaptor and installation on main voltage 3-circuit track system.
- Spot light adjustable 358° rotating around the vertical axis and 90° rotating around the horizontal axis.
- Anti-dazzle ring: Plastic black.
- Light spot pipe is available, which could make the light more soft and more perfect.
- Light source: COB LED with a high efficiency reflector of optical.

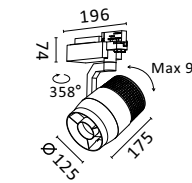

COB LED

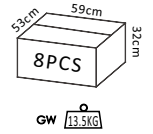

**T6033 20W 1550lm**  
With LED Driver 36V-500mA  
230V-50Hz

NW  
1.41kg

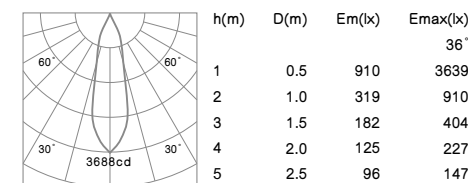
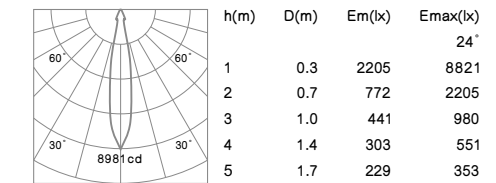
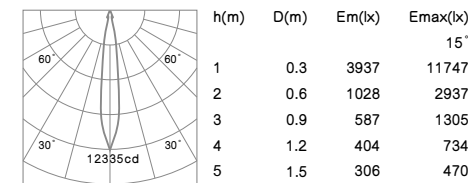



# Track Spot Light L

**T6033 25W 1770lm**  
With LED Driver 36V-600mA  
230V-50Hz

NW  
1.41kg

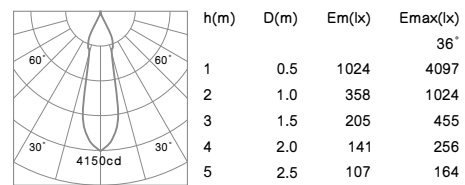
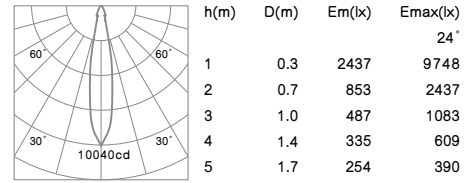
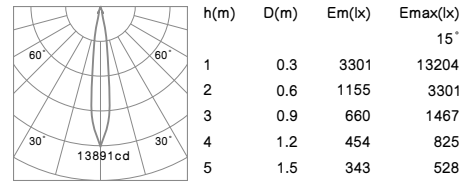

**T6033 30W 2300lm**  
With LED Driver 36V-800mA  
230V-50Hz

NW  
1.41kg

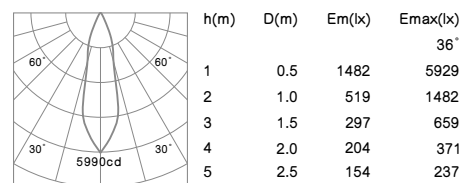
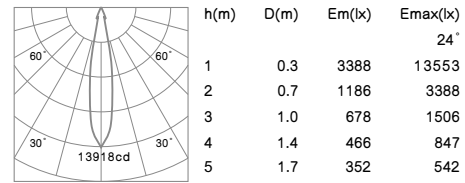
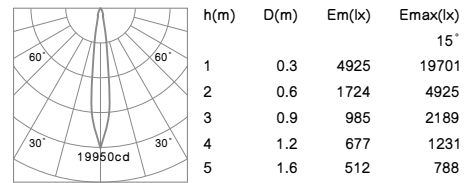

# Track Spot Light L

**T6033 40W 3000lm**  
With LED Driver 36V-1050mA  
230V-50Hz

NW  
1.41kg

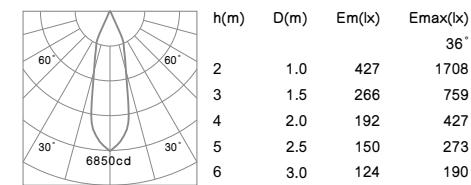
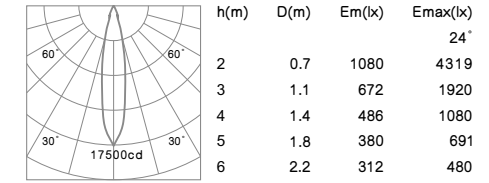
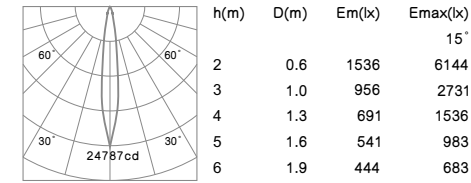

## Track accessories

VENEZINA 3-circuit track is made of pure aluminum and molded through extrusion, with white or silver powder-coating. 4 red brass conductors and insulation materials are inside. A large number of connectors is available, almost all connectors can be used for electrical power supply. The circuits can be designed with one switch controlling the entire track or three switches controlling each circuit on the track respectively as required. The track can be mounted on the ceiling or walls, it can also be suspended using pendant tubes or wire ropes. The introduction of the track brings the flexibility to construction lighting system, settles the problem of limitations on lamp installation of traditional lighting, enables easy rearrangement and adjustment of lamps and makes lamp installation and replacement more convenient and efficient.

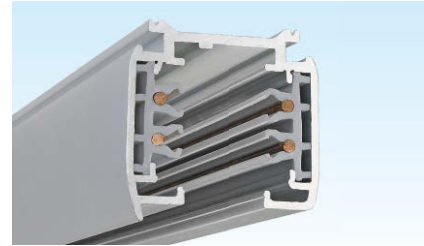

### Single Circuit DALI Track System

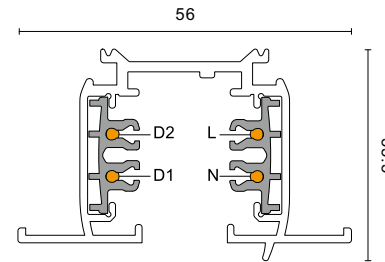
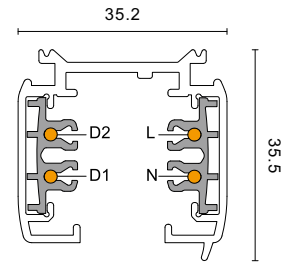
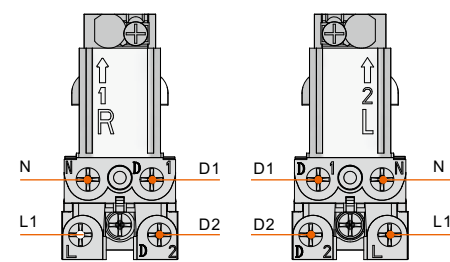

### 1-Circuit and 3-Circuit Track System

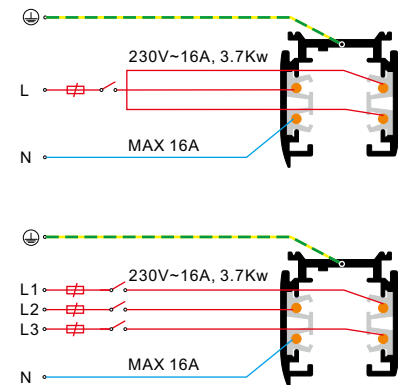
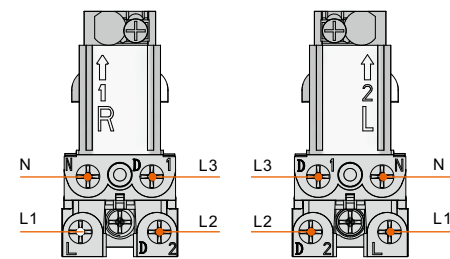

**1-Circuit**  
For this type of connection, the 3-circuits on the entire track are controlled through one switch.

**3-Circuit**  
For this type of connection, each circuit is controlled through one switch.

## Track accessories

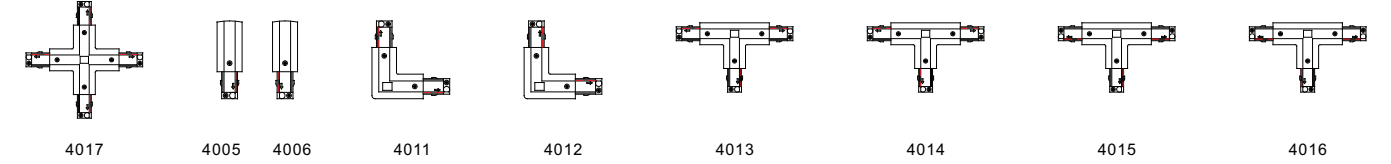

According to the circuit input in different situations, a connector conforming to the input end can be selected to connect with the track so as to meet the requirement on power supply to the illumination lamps.

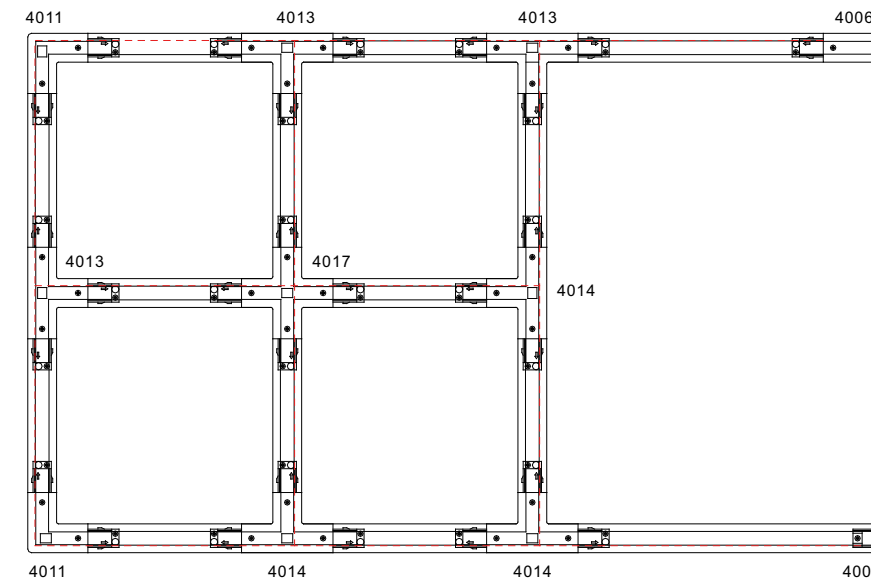

With large number of track connectors, the tracks can be arranged into different patterns as required by the user, so as to meet the illumination requirements in different situations and achieve different lighting effects.

According to different luminous environments and user requirements, the ceiling flush VENEZINA tracks can be arranged in linear, L-Shaped and rectangular formations by using "+", "-", "T", "L" connector. In addition, it can make the electrical connection to a lamp with a 3-wire connector, totally breaking the limitations on traditional lighting.

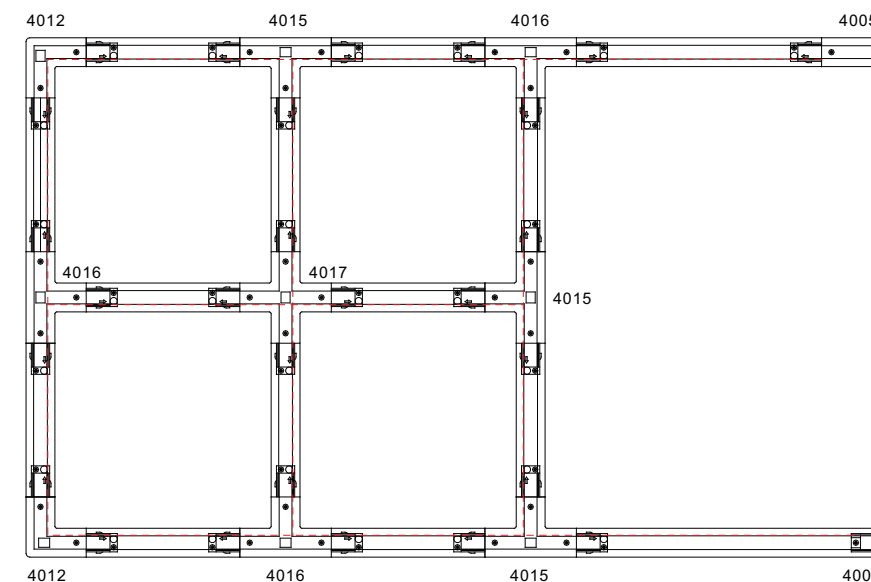

## Track accessories

### Surface-mounted



Track and mounting kits color: White Silver Black

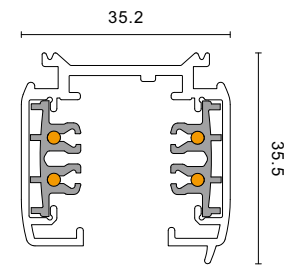

VENEZINA 3-circuit track is available in lengths up to 3M. When connected to a three-phase net work, each of the three circuits can be loaded to a maximum of 16A. Each red brass conductors are separately protected by isolation materials, to avoid the interfering from each other. The lamps mounted on each track shall not exceed its rated load.

**4001**  
1M track actual one meter  
Aluminum profile, powder-coated

NW  
0.88kg

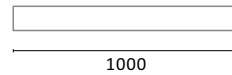

**4002**  
2M track actual one meter  
Aluminum profile, powder-coated

NW  
1.75kg

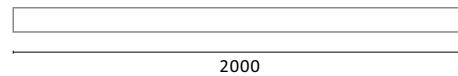

**4003**  
3M track actual one meter  
Aluminum profile, powder-coated

NW  
2.64kg

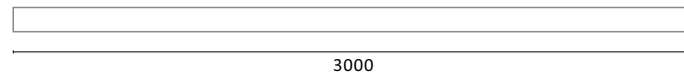

### Mounting kits

**4021**  
Suspension kit with  $\varnothing 6\text{mm} \times 1\text{m}$  rod

NW  
0.24kg



**4022**  
Suspension kit with 1.5m wire

NW  
0.08kg



**4023**  
Suspension kit

NW  
0.04kg



## Track accessories

### Recessed

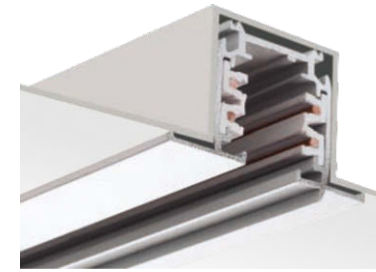

Track and mounting kits color: White Silver Black

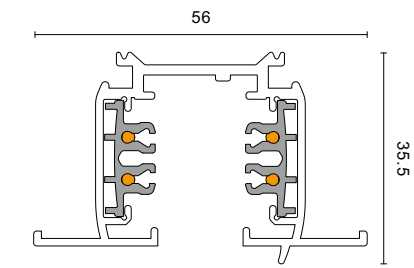

VENEZINA 3-circuit track is available in flanged track in length up to 3M. When connected to a three-phase net work, each of the three circuits can be loaded to a maximum of 16A. Each red brass conductors are separately protected by isolation materials, to avoid the interfering from each other. The lamps mounted on each track shall not exceed its rated load.

**4018**  
1M track actual one meter  
Aluminum profile, powder-coated

NW  
0.95kg

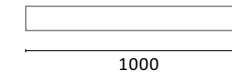

**4019**  
2M track actual one meter  
Aluminum profile, powder-coated

NW  
1.90kg

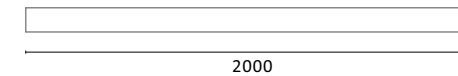

**4020**  
3M track actual one meter  
Aluminum profile, powder-coated

NW  
2.85kg

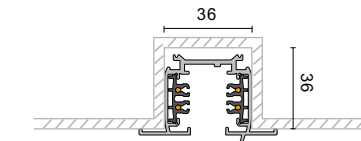
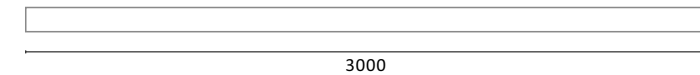

## Track accessories

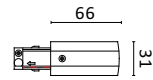

**4005**  
live-end connector  
To star a run

NW  
0,05kg

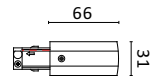

**4006**  
live-end connector  
To star a run

NW  
0,05kg

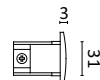

**4007**  
End cap connectors  
To the track section end

NW  
0,01kg

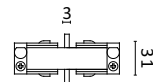
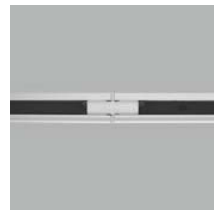

**4008**  
Mini joiner  
A low profile connector to join two straight track sections end-to-end

NW  
0,03kg

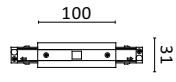
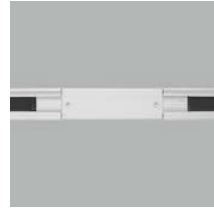

**4009**  
Straight connector  
To connect two track sections end-to-end  
It provides a center feed option

NW  
0,11kg

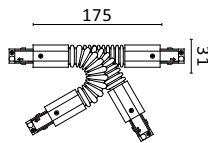
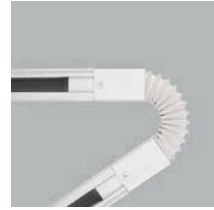

**4010**  
Flexible connector  
To connect two track sections at any angle up to 90° or wall to ceiling or pitched ceiling applications.

NW  
0,15kg

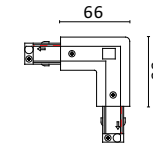

**4011**  
"L" connector  
To connect two track sections at 90° angle

NW  
0,11kg

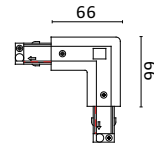

**4012**  
"L" connector  
To connect two track sections at 90° angle

NW  
0,11kg

## Track accessories

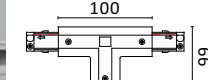
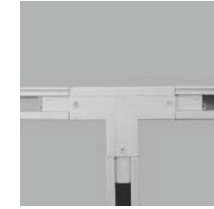

**4013**  
"T" connector  
To connect three track sections into a T configuration

NW  
0,16kg

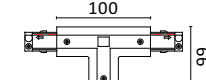

**4014**  
"T" connector  
To connect three track sections into a T configuration

NW  
0,16kg

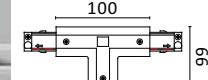
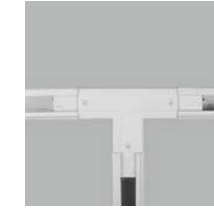

**4015**  
"T" connector  
To connect three track sections into a T configuration

NW  
0,16kg

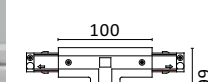

**4016**  
"T" connector  
To connect three track sections into a T configuration

NW  
0,16kg

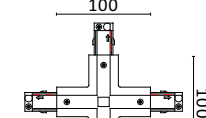
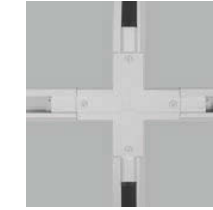

**4017**  
"T" connector  
To connect four track sections into a cross configuration

NW  
0,22kg

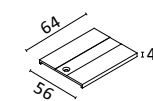
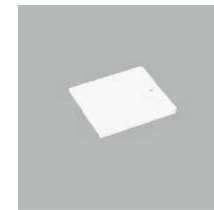

**4024**  
For model: 4005-4006

NW  
0,01kg

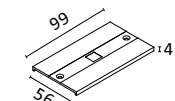

**4025**  
For model: 4009

NW  
0,01kg

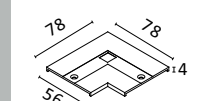
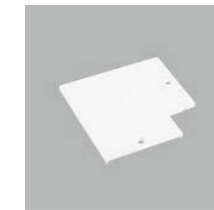

**4026**  
For model: 4011-4012

NW  
0,01kg

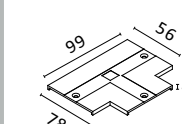
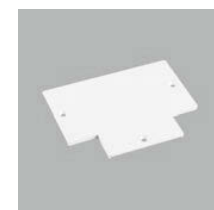

**4027**  
For model: 4013-4014-4015-4016

NW  
0,02kg

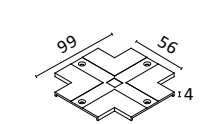
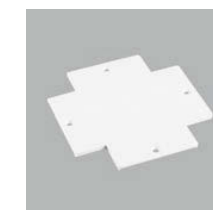

**4028**  
For model: 4017

NW  
0,02kg



# Surface-mounted Spot Light MS



**COB LED CRI≥80 IP20 CE RoHS**

Housing color: White Silver Black  
 Color temperature: 2700K 3000K 4000K  
 Beam angle: 15° 24° 36° 60°

Driver gear for LED: Non-Dimmable

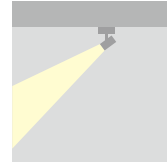

- Housing: Pure aluminum.
- Spot light adjustable 358° rotating around the vertical axis and 90° rotating around the horizontal axis.
- Mounting plate: Steel sheet.
- Anti-dazzle ring: Pure aluminum.
- Light spot pipe is available, which could make the light more soft and more perfect.
- Light source: COB LED with a high efficiency reflector of optical.

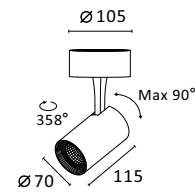

COB LED

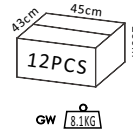

**C6050 10W 1050lm**  
 With LED Driver 36V-250mA  
 230V-50Hz

NW  
 0.54kg

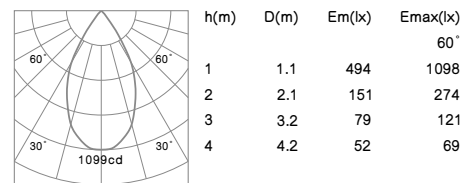
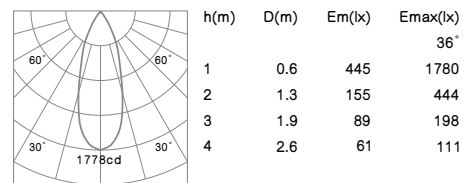
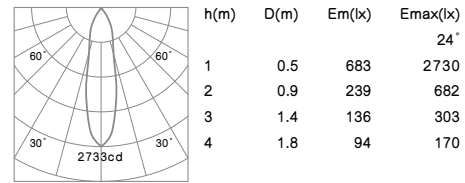
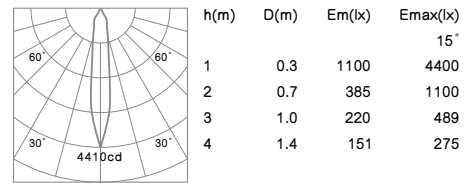

# Surface-mounted Spot Light MS

**C6050 15W 1350lm**  
 With LED Driver 36V-350mA  
 230V-50Hz

NW  
 0.54kg

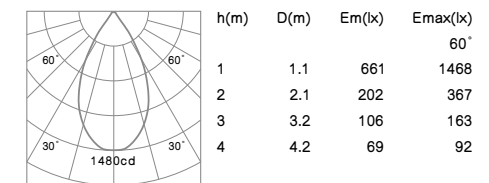
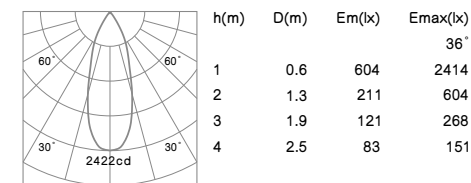
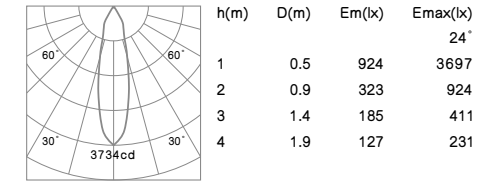
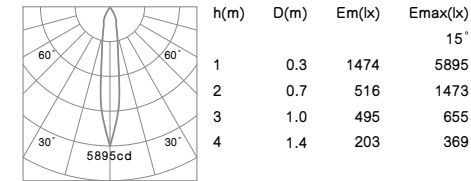

# Surface-mounted Spot Light MD



**COB LED CRI≥80 IP20 CE RoHS**

Housing color: White Silver Black  
 Color temperature: 2700K 3000K 4000K  
 Beam angle: 15° 24° 36° 60°

Driver gear for LED: Non-Dimmable

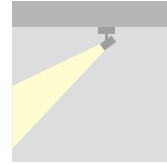

- Housing: Pure aluminum.
- Spot light adjustable 358° rotating around the vertical axis and 90° rotating around the horizontal axis.
- Mounting plate: Steel sheet.
- Anti-dazzle ring: Pure aluminum.
- Light spot pipe is available, which could make the light more soft and more perfect.
- Light source: COB LED with a high efficiency reflector of optical.

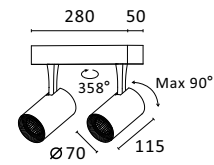

COB LED

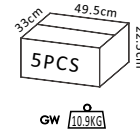

**C6257 2x10W 2100lm**  
 With 2 pieces of LED Driver 36V-250mA  
 230V-50Hz

NW  
 1.11kg

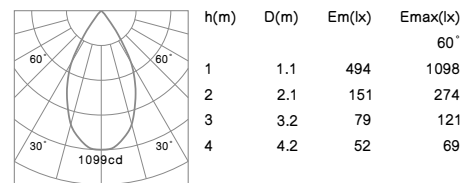
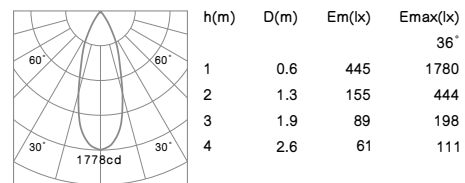
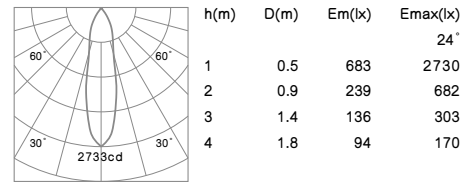
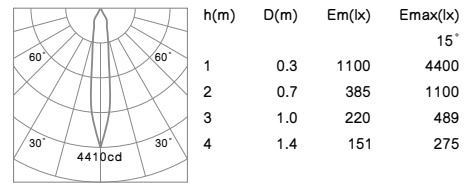

# Surface-mounted Spot Light MD

**C6257 2x15W 2700lm**  
 With 2 pieces of LED Driver 36V-350mA  
 230V-50Hz

NW  
 1.11kg

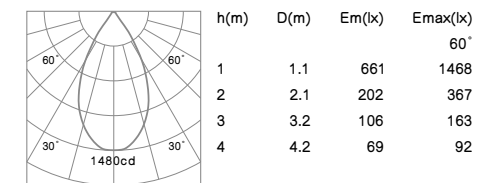
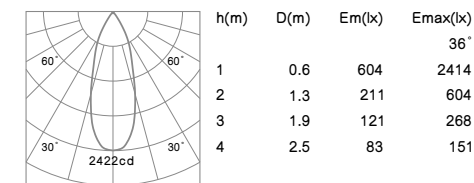
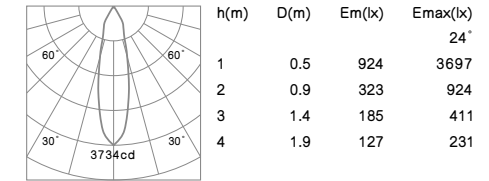
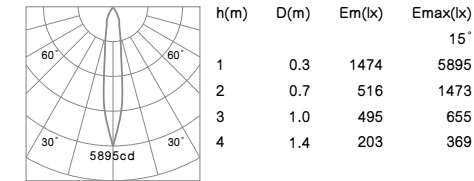

# Surface-mounted Spot Light MT



**COB LED CRI≥80 IP20 CE RoHS**

Housing color: White Silver Black  
 Color temperature: 2700K 3000K 4000K  
 Beam angle: 15° 24° 36° 60°

Driver gear for LED: Non-Dimmable

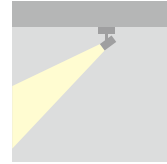

- Housing: Pure aluminum.
- Spot light adjustable 358° rotating around the vertical axis and 90° rotating around the horizontal axis.
- Mounting plate: Steel sheet.
- Anti-dazzle ring: Pure aluminum.
- Light spot pipe is available, which could make the light more soft and more perfect.
- Light source: COB LED with a high efficiency reflector of optical.

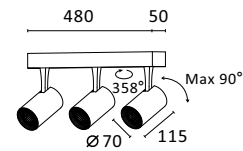

COB LED

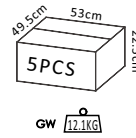

GW 17.1KG

**C6300 3x10W 3150lm**  
 With 3 pieces of LED Driver 36V-250mA  
 230V-50Hz

NW  
 1.71kg

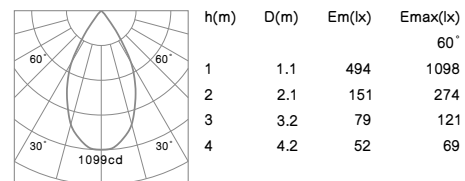
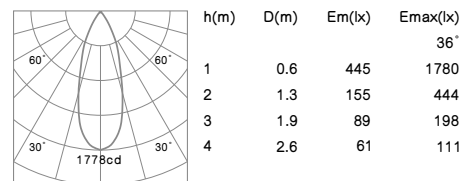
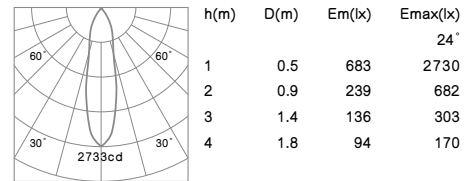
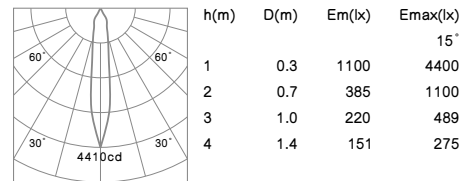

# Surface-mounted Spot Light MT

**C6300 3x15W 4050lm**  
 With 3 pieces of LED Driver 36V-350mA  
 230V-50Hz

NW  
 1.71kg

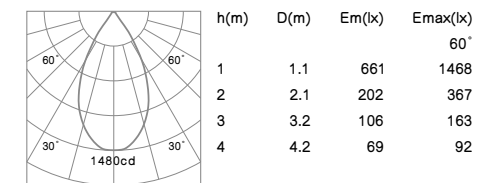
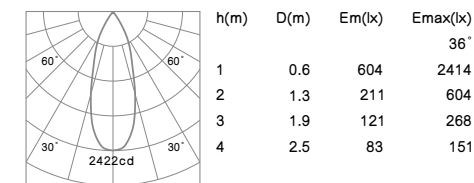
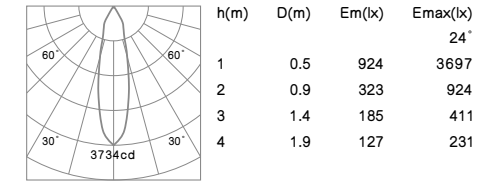
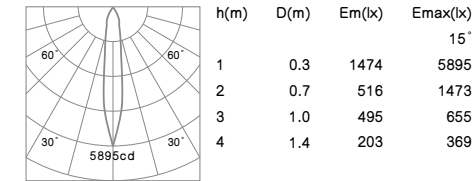

# Surface-mounted Spot Light s



**COB LED CRI≥80 IP20 CE RoHS**

Housing color: White Silver Black  
 Color temperature: 2700K 3000K 4000K  
 Beam angle: 10° 20° 30°

Driver gear for LED: Non-Dimmable

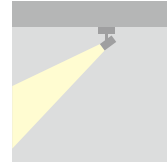

- Housing and bracket: Cast aluminum.
- Spot light adjustable 358° rotating around the vertical axis and 90° rotating around the horizontal axis.
- Anti-dazzle ring: Pure aluminum.
- Light source: COB LED with a lens of optical.

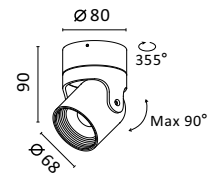

COB LED

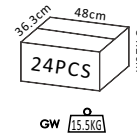

**C6026 6W 530lm**  
 With LED Driver 36V-150mA  
 230V-50Hz

NW  
 0.59kg

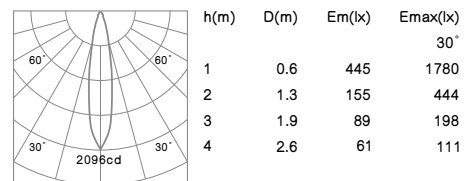
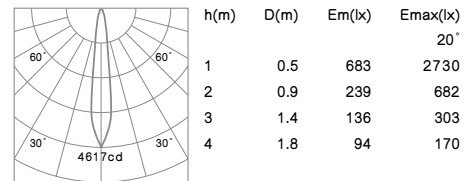
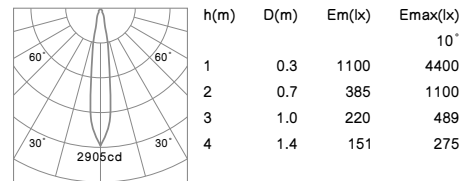

# Surface-mounted Spot Light s

**C6026 10W 900lm**  
 With LED Driver 36V-250mA  
 230V-50Hz

NW  
 0.59kg

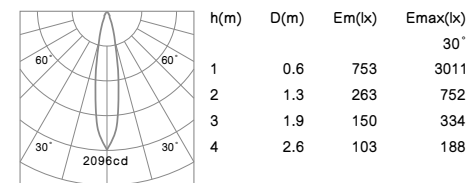
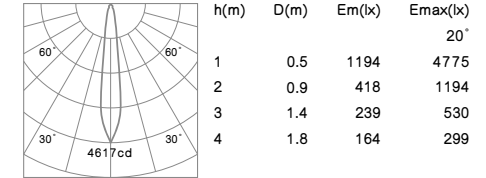
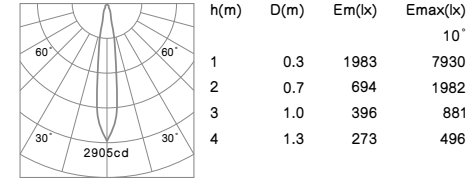



# Surface-mounted Spot Light s



**COB LED CRI≥80 IP20 CE RoHS**

Housing color: White Silver Black  
 Color temperature: 2700K 3000K 4000K  
 Beam angle: 15° 24° 36° 60°

Driver gear for LED: Non-Dimmable

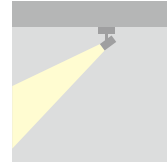

- Housing and bracket: Cast aluminum.
- Spot light adjustable 358° rotating around the vertical axis and 90° rotating around the horizontal axis.
- Mounting ring: Pure aluminum.
- Anti-dazzle ring: Plastic black.
- Light source: COB LED with a high efficiency reflector of optical.

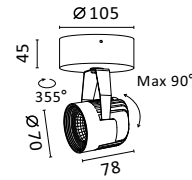

COB LED

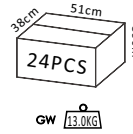

## C6034 6W 550lm With LED Driver 36V-150mA 230V-50Hz

NW  
0.64kg

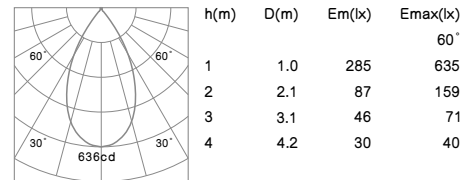
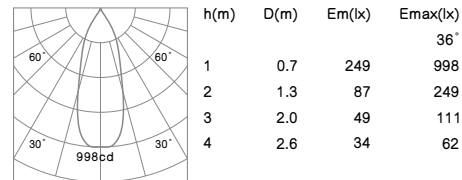
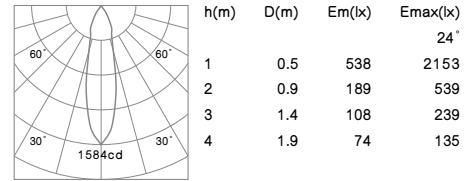
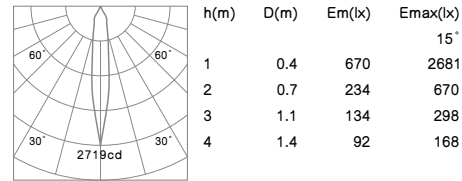

# Surface-mounted Spot Light s

## C6034 10W 1050lm With LED Driver 36V-250mA 230V-50Hz

NW  
0.64kg

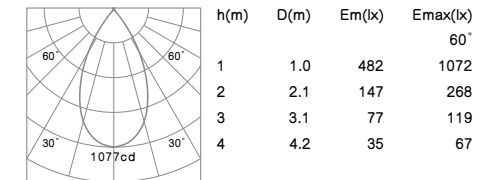
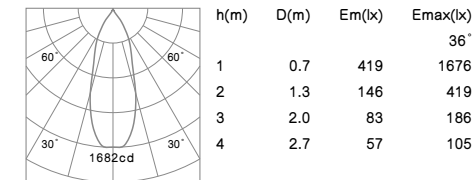
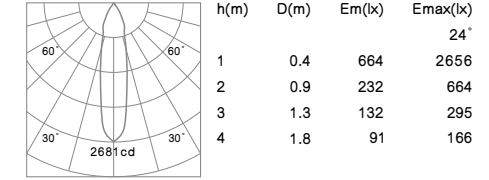
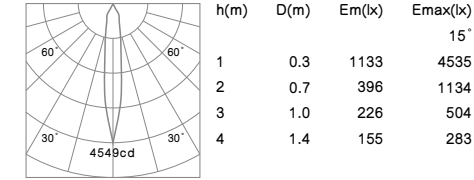

## C6034 15W 1370lm With LED Driver 36V-350mA 230V-50Hz

NW  
0.64kg

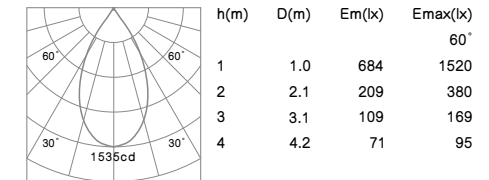
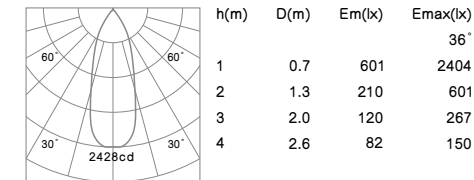
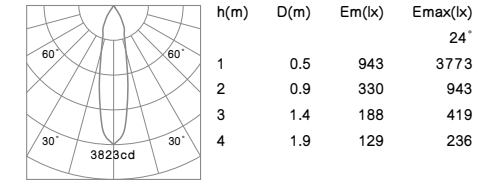
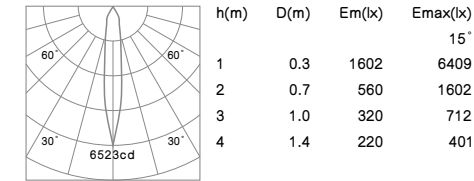

# Surface-mounted Spot Light M



**COB LED CRI≥80 IP20 CE RoHS**

Housing color: White Silver Black  
 Color temperature: 2700K 3000K 4000K  
 Beam angle: 15° 24° 36° 60°

Driver gear for LED: Non-Dimmable

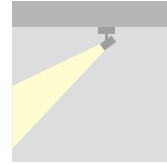

- Housing and bracket: Cast aluminum.
- Spot light adjustable 358° rotating around the vertical axis and 90° rotating around the horizontal axis.
- Mounting ring: Pure aluminum.
- Anti-dazzle ring: Plastic black.
- Light spot pipe is available, which could make the light more soft and more perfect.
- Light source: COB LED with a high efficiency reflector of optical.

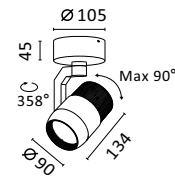

COB LED

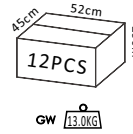

**C6054 15W 1450lm**  
 With LED Driver 36V-350mA  
 230V-50Hz

NW  
 1.06kg

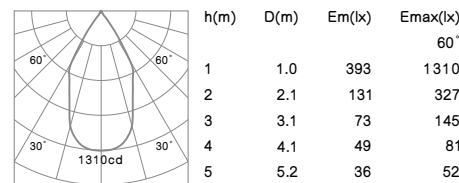
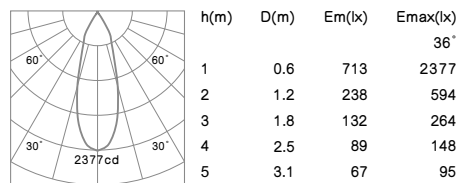
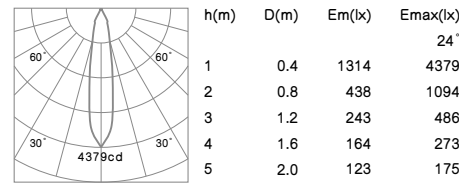
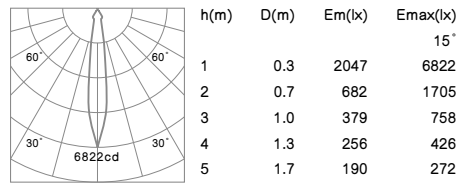

# Surface-mounted Spot Light M

**C6054 20W 2000lm**  
 With LED Driver 36V-500mA  
 230V-50Hz

NW  
 1.06kg

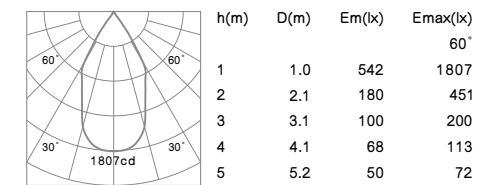
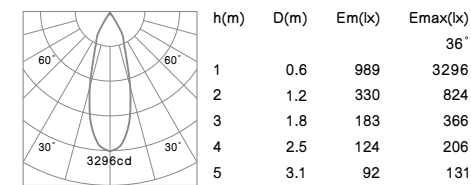
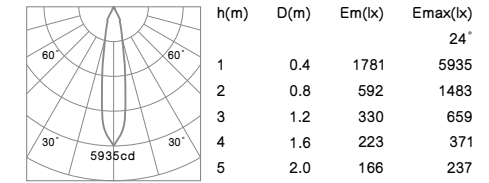
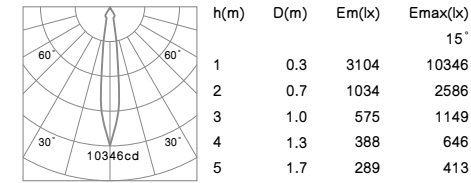

**C6054 25W 2250lm**  
 With LED Driver 36V-600mA  
 230V-50Hz

NW  
 1.06kg

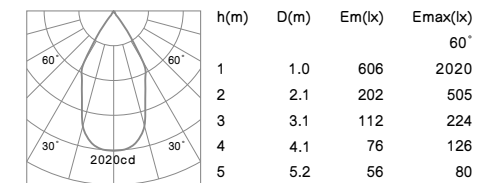
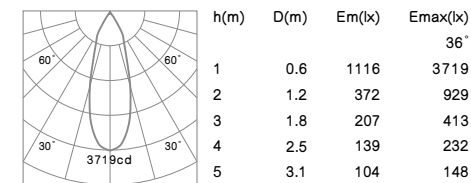
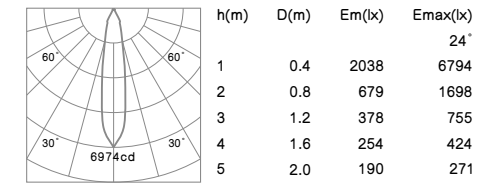
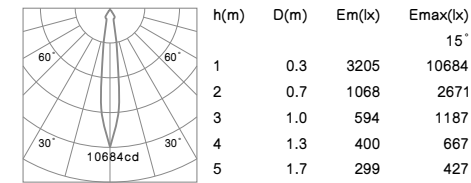

# Surface-mounted Spot Light



**COB LED CRI≥80 IP20 CE RoHS**

Housing color: White Silver Black  
 Color temperature: 2700K 3000K 4000K  
 Beam angle: 15° 24° 36° 60°

Driver gear for LED: Non-Dimmable

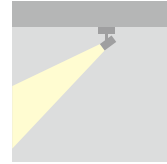

- Housing and bracket: Cast aluminum.
- Spot light adjustable 358° rotating around the vertical axis and 90° rotating around the horizontal axis.
- Mounting ring: Pure aluminum.
- Anti-dazzle ring: Plastic black.
- Light spot pipe is available, which could make the light more soft and more perfect.
- Light source: COB LED with a high efficiency reflector of optical.

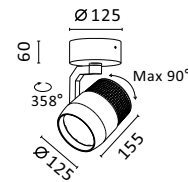

COB LED

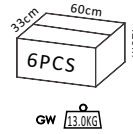

**C6063 25W 2350lm**  
 With LED Driver 36V-600mA  
 230V-50Hz

NW  
 1.59kg

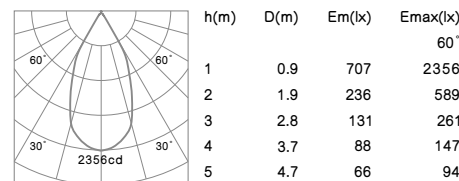
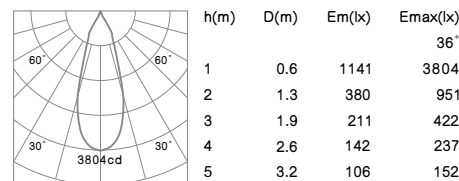
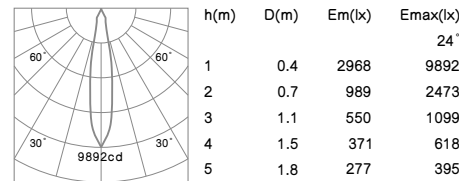
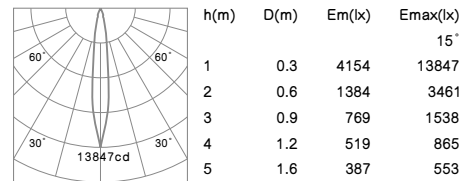

# Surface-mounted Spot Light

**C6063 30W 3100lm**  
 With LED Driver 36V-800mA  
 230V-50Hz

NW  
 1.59kg

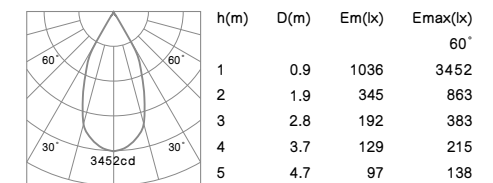
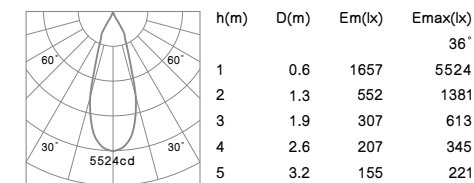
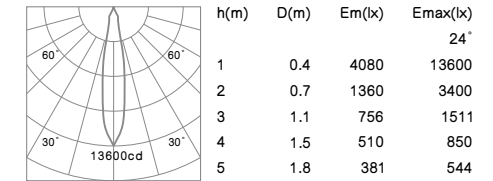
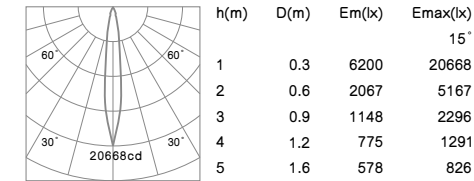

**C6063 40W 4000lm**  
 With LED Driver 36V-10500mA  
 230V-50Hz

NW  
 1.59kg

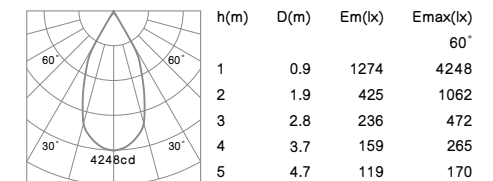
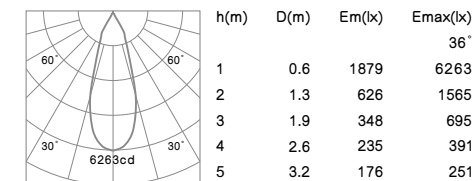
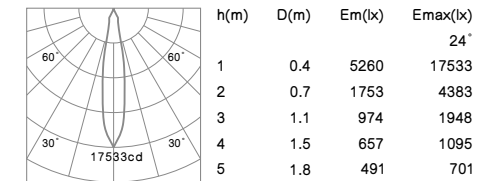
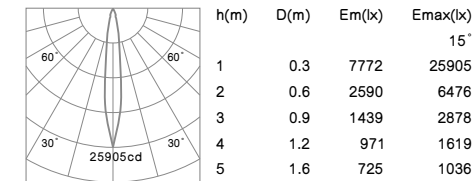

# Recessed Spot Light M



**COB LED CRI≥80 IP20 CE RoHS**

Housing color: White Silver Black  
 Color temperature: 2700K 3000K 4000K  
 Beam angle: 15° 24° 36° 60°

Driver gear for LED:  
 Non-Dimmable  
 1-10V Dimmable  
 DALI Dimmable  
 Triac Dimmable

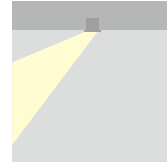

- Housing and bracket: Cast aluminum.
- Spot light adjustable 358° rotating around the vertical axis and 90° rotating around the horizontal axis.
- Anti-dazzle ring: Plastic black.
- Light spot pipe is available, which could make the light more soft and more perfect.
- Light source: COB LED with a high efficiency reflector of optical.
- The light can be compatible with emergency battery.

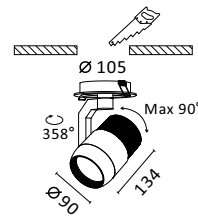

COB LED

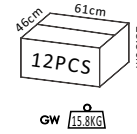

**R6301 15W 1450lm**  
 With LED Driver 36V-350mA  
 230V-50Hz

NW  
 1.10kg

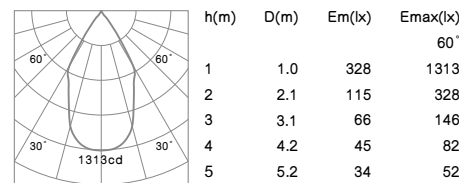
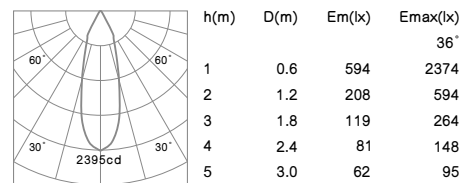
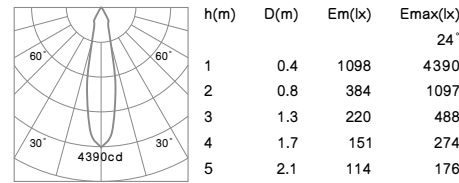
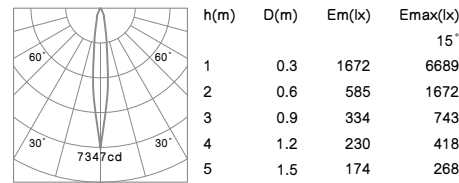

# Recessed Spot Light M

**R6301 20W 2100lm**  
 With LED Driver 36V-500mA  
 230V-50Hz

NW  
 1.10kg

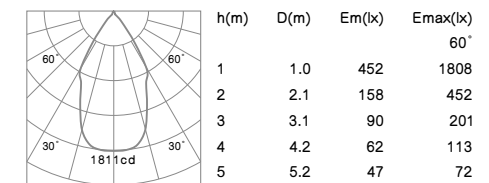
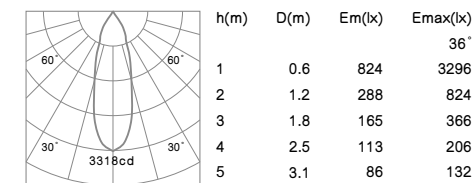
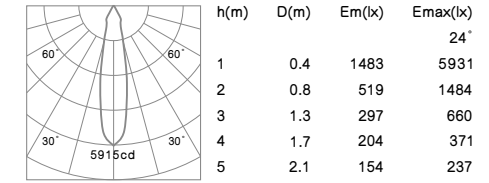
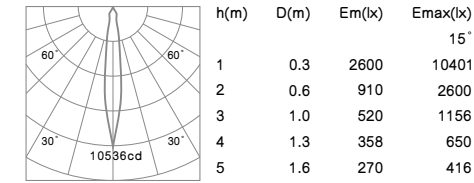

**R6301 25W 2250lm**  
 With LED Driver 36V-600mA  
 230V-50Hz

NW  
 1.10kg

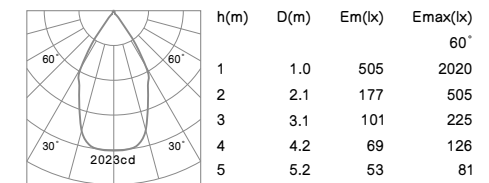
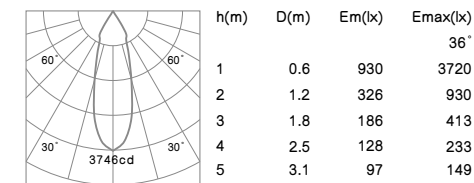
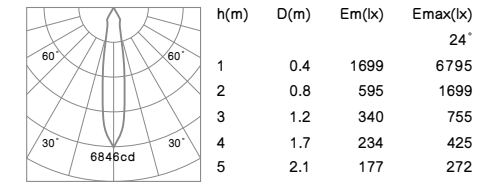
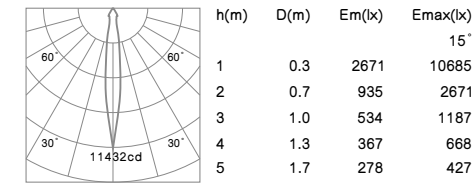



# Recessed Spot Light M



**COB LED CRI≥80 IP20 CE RoHS**

Housing color: White Silver Black  
 Color temperature: 2700K 3000K 4000K  
 Beam angle: 15° 24° 36°

Driver gear for LED:  
 Non-Dimmable  
 1-10V Dimmable  
 DALI Dimmable  
 Triac Dimmable

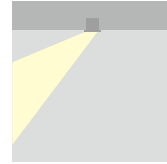

- Housing and bracket: Cast aluminum.
- Spot light adjustable 358° rotating around the vertical axis and 90° rotating around the horizontal axis.
- Anti-dazzle ring: Plastic black.
- Light spot pipe is available, which could make the light more soft and more perfect.
- Light source: COB LED with a high efficiency reflector of optical.
- The light can be compatible with emergency battery.

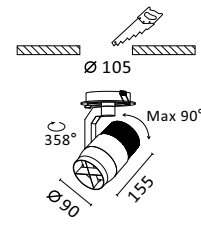

COB LED

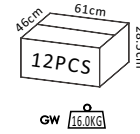

## R6307 15W 1050lm With LED Driver 36V-350mA 230V-50Hz

NW  
1.13kg

h(m)	D(m)	Em(lx)	Emax(lx)
1	0.3	1690	6758
2	0.6	591	1689
3	0.9	338	751
4	1.3	232	422
5	1.6	176	270

h(m)	D(m)	Em(lx)	Emax(lx)
1	0.4	960	3838
2	0.7	336	960
3	1.1	192	427
4	1.5	132	240
5	1.8	100	154

h(m)	D(m)	Em(lx)	Emax(lx)
1	0.5	535	2138
2	1.1	187	535
3	1.6	107	238
4	2.2	74	134
5	2.7	556	86

h(m)	D(m)	Em(lx)	Emax(lx)
1	0.4	960	3838
2	0.7	336	960
3	1.1	192	427
4	1.5	132	240
5	1.8	100	154

# Recessed Spot Light M

## R6307 20W 1430lm With LED Driver 36V-500mA 230V-50Hz

NW  
1.13kg

h(m)	D(m)	Em(lx)	Emax(lx)
1	0.3	2365	9460
2	0.6	818	2365
3	1.0	473	1051
4	1.3	325	591
5	1.6	246	378

h(m)	D(m)	Em(lx)	Emax(lx)
1	0.4	1299	5194
2	0.8	455	1299
3	1.2	260	577
4	1.6	179	325
5	2.0	135	208

h(m)	D(m)	Em(lx)	Emax(lx)
1	0.6	722	2886
2	1.2	253	722
3	1.8	144	321
4	2.5	99	180
5	3.1	75	115

## R6307 25W 1620lm With LED Driver 36V-600mA 230V-50Hz

NW  
1.13kg

h(m)	D(m)	Em(lx)	Emax(lx)
1	0.3	2660	10640
2	0.6	931	2660
3	1.0	532	1182
4	1.3	366	665
5	1.6	277	426

h(m)	D(m)	Em(lx)	Emax(lx)
1	0.4	1699	6795
2	0.8	595	1699
3	1.2	340	755
4	1.7	234	425
5	2.1	177	272

h(m)	D(m)	Em(lx)	Emax(lx)
1	0.5	829	3317
2	1.0	2901	829
3	1.6	166	369
4	2.2	114	207
5	2.7	86	133

# Recessed Spot Light



**COB LED CRI≥80 IP20 CE RoHS**

Housing color: White Silver Black  
 Color temperature: 2700K 3000K 4000K  
 Beam angle: 15° 24° 36° 60°

Driver gear for LED:  
 Non-Dimmable  
 1-10V Dimmable  
 DALI Dimmable  
 Triac Dimmable

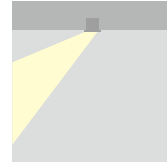

- Housing and bracket: Cast aluminum.
- Spot light adjustable 358° rotating around the vertical axis and 90° rotating around the horizontal axis.
- Anti-dazzle ring: Plastic black.
- Light spot pipe is available, which could make the light more soft and more perfect.
- Light source: COB LED with a high efficiency reflector of optical.
- The light can be compatible with emergency battery.

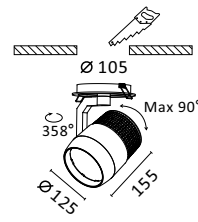

COB LED

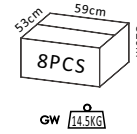

**R6302 20W 2050lm**  
 With LED Driver 36V-500mA  
 230V-50Hz

NW  
 1.52kg

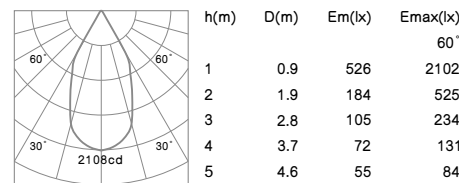
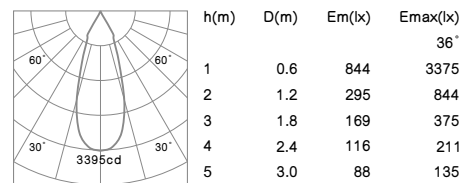
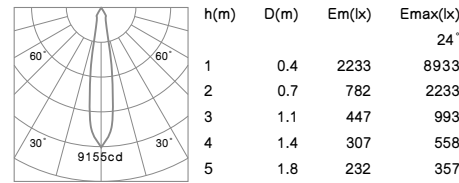
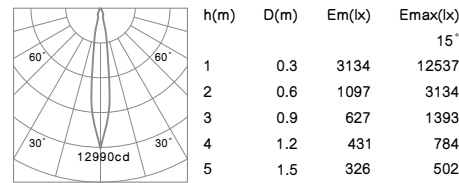

# Recessed Spot Light

**R6302 25W 2350lm**  
 With LED Driver 36V-600mA  
 230V-50Hz

NW  
 1.52kg

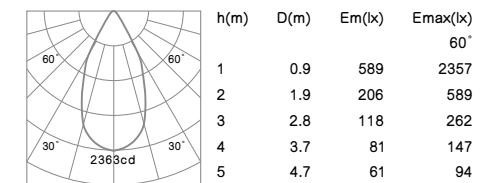
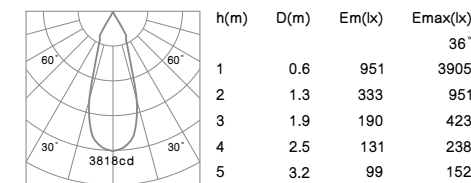
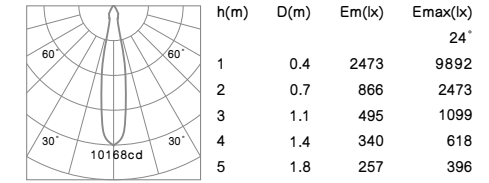
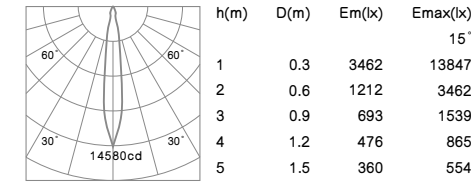

**R6302 30W 3100lm**  
 With LED Driver 36V-800mA  
 230V-50Hz

NW  
 1.52kg

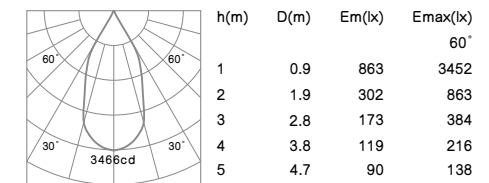
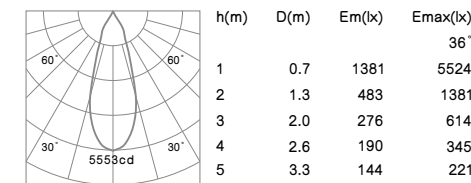
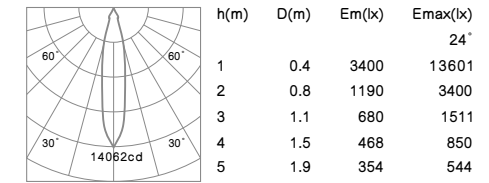
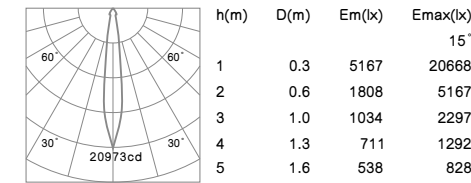

# Recessed Spot Light L

**R6302 40W 4000lm**  
With LED Driver 36V-1050mA  
230V-50Hz

NW  
1.52kg

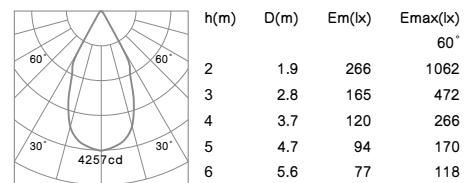
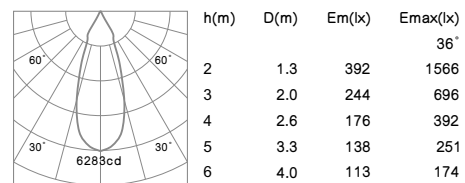
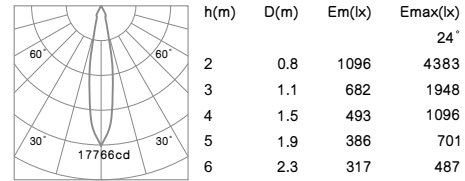
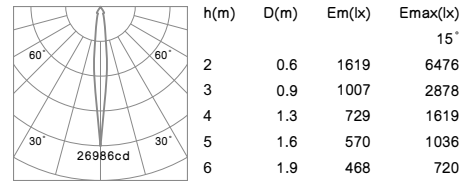

# Recessed Spot Light L

**COB LED CRI≥80 IP20 CE RoHS**

Housing color: White Silver Black  
Color temperature: 2700K 3000K 4000K  
Beam angle: 15° 24° 36°

Driver gear for LED: Non-Dimmable  
1-10V Dimmable  
DALI Dimmable  
Triac Dimmable

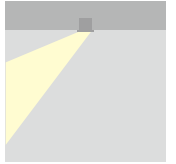

- Housing and bracket: Cast aluminum.
- Spot light adjustable 358° rotating around the vertical axis and 90° rotating around the horizontal axis.
- Anti-dazzle ring: Plastic black.
- Light spot pipe is available, which could make the light more soft and more perfect.
- Light source: COB LED with a high efficiency reflector of optical.
- The light can be compatible with emergency battery.

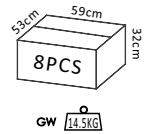
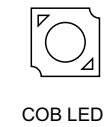
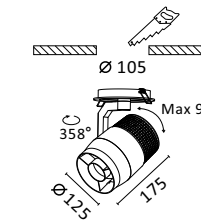

**R6308 20W 1550lm**  
With LED Driver 36V-500mA  
230V-50Hz

NW  
1.56kg

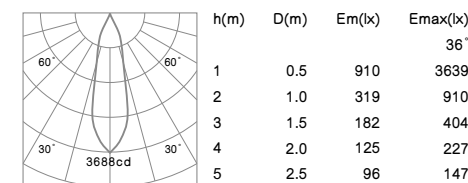
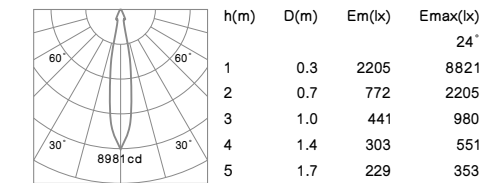
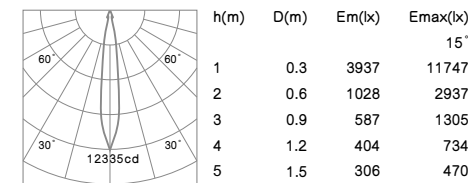

# Recessed Spot Light L

**R6308 25W 1770lm**  
With LED Driver 36V-600mA  
230V-50Hz

NW  
1.56kg

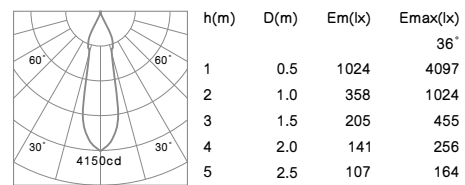
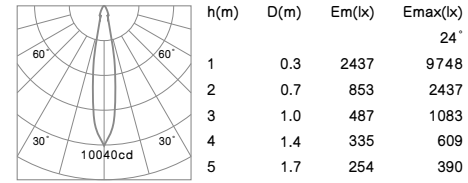
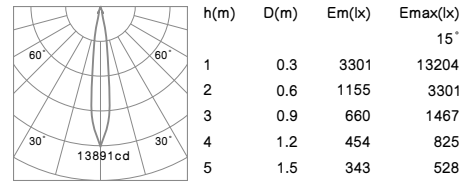

**R6308 30W 2300lm**  
With LED Driver 36V-800mA  
230V-50Hz

NW  
1.56kg

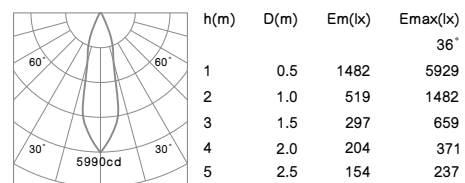
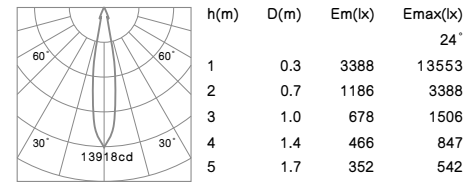
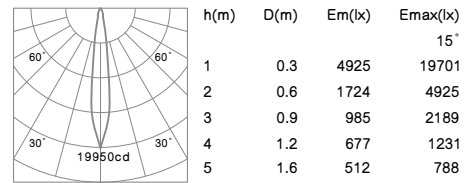

# Recessed Spot Light L

**R6308 40W 3000lm**  
With LED Driver 36V-1050mA  
230V-50Hz

NW  
1.56kg

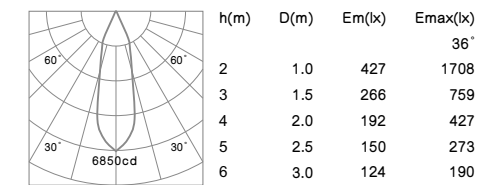
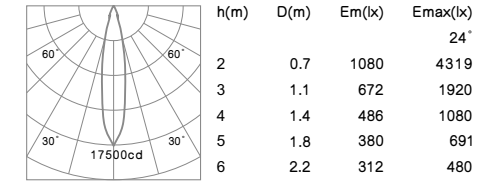
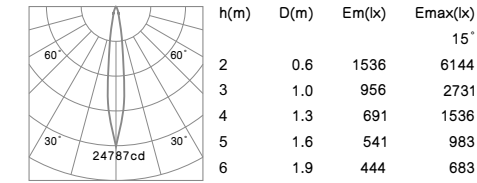



WALA



481

WALA



482







WALA

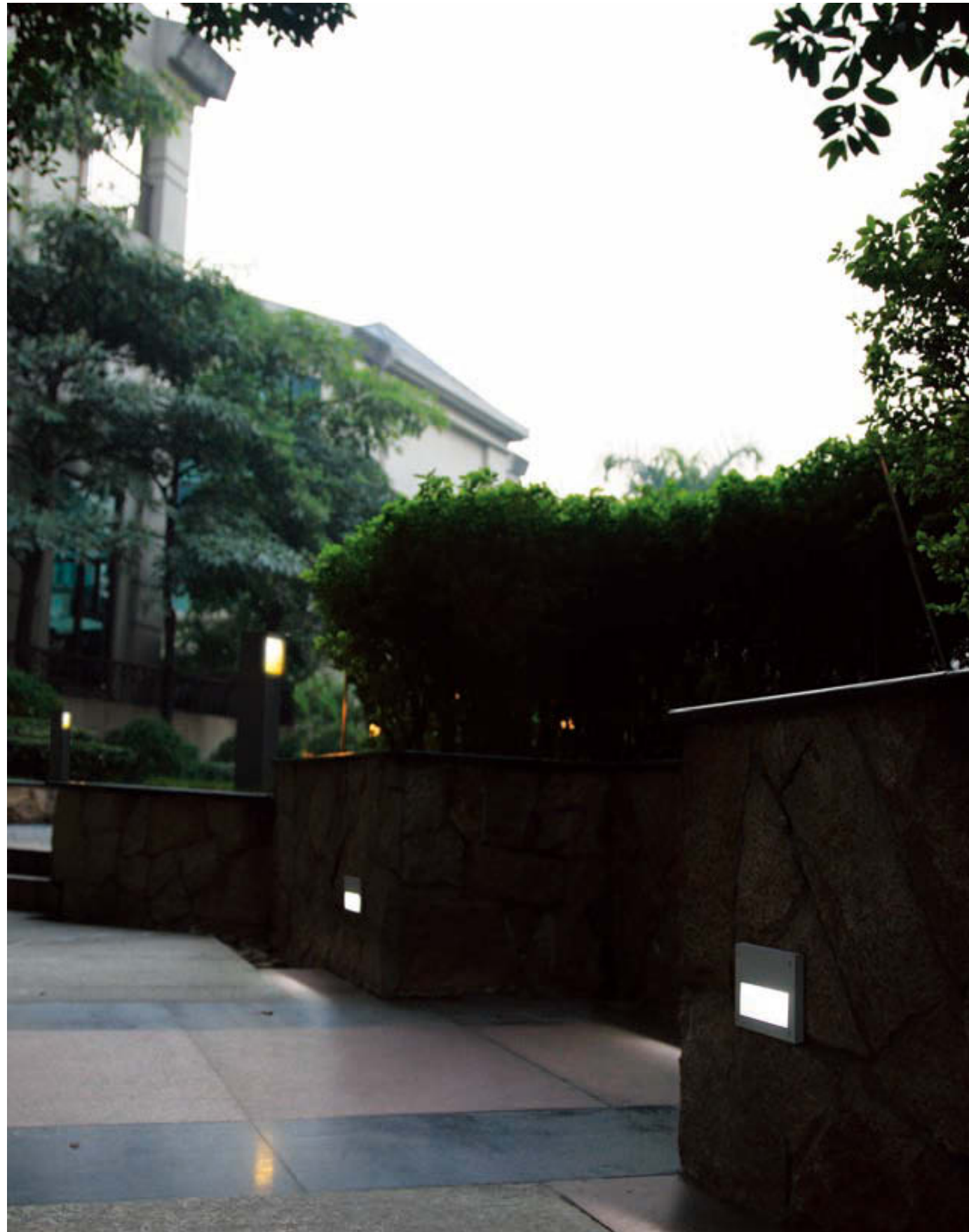

WALA

Interior



85.5x85.5x90mm 2x3W

P489



85.5x85.5x200mm 2x8W

P490



85.5x85.5x420mm 2x8W

P491



85.5x85.5x420mm 2x8W+SMD5W

P492



85.5x85.5x720mm 2x8W

P493





85.5x85.5x720mm 2x8W+SMD10W

P494

# WALA

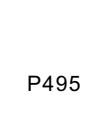
## Interior

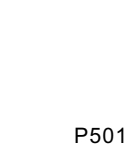
	80x90x49mm	5W	P495
	80x126x49mm	2x3W	P495
	80x50x61mm	5W	P496
	Ø 80x174mm	2x5W	P496
	65x65x72mm	5W / 2x3W	P497
	100x100x100mm	2x5W	P498
	80x80mm	3W	P499

# WALA

## Exterior

	Ø 80x80mm	5W	P501
	Ø 80x174mm	2x5W	P502
	100x100x100mm	2x5W	P503
	Ø 100mm	5W	P504
	100x100mm	5W	P505
	100x150mm	5W	P505
	150x100mm	5W	P506



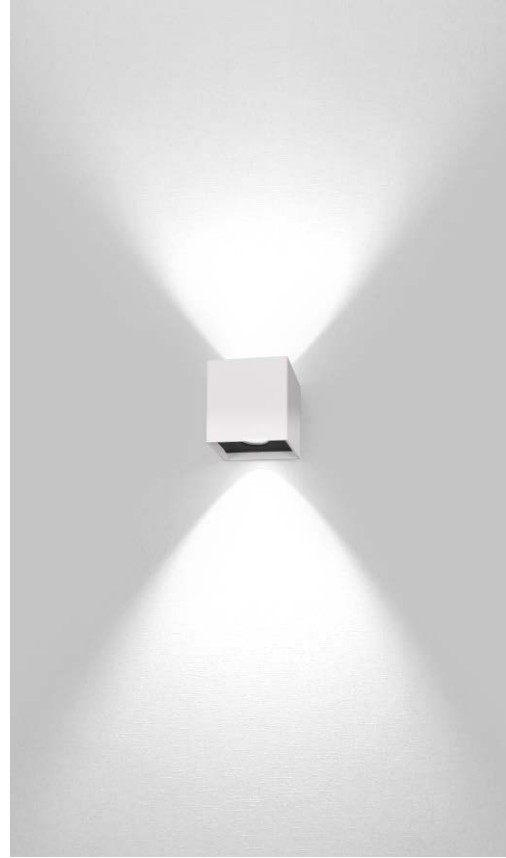

**COB LED CRI≥80 IP20 CE RoHS**  
 Housing color: White Silver Black Aluminum Brush  
 Color temperature: 2700K 3000K 4000K

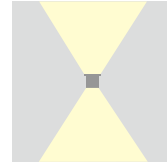

- Screwless design with magnetic mounted to make fixture looks more simple and elegant.
- Comfortable and symmetric light performance.
- Light housing: Pure aluminum.
- Surface mounted and no need wall-mounted plate.
- Light source: COB LED with a reflector of high optical.

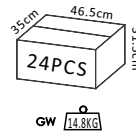
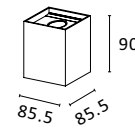

**W6186 2x3W 380lm**  
 With LED Driver 9V-500mA  
 230V-50Hz

NW  
 0.55kg

**COB LED CRI≥80 IP20 CE RoHS**  
 Housing color: White Silver Black Aluminum Brush  
 Color temperature: 2700K 3000K 4000K

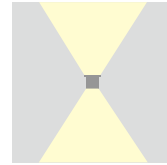

- Screwless design with magnetic mounted to make fixture looks more simple and elegant.
- Comfortable and symmetric light performance.
- Light housing: Pure aluminum.
- Surface mounted and no need wall-mounted plate.
- Light source: COB LED with a reflector of high optical.

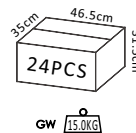
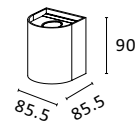

**W6187 2x3W 380lm**  
 With LED Driver 9V-500mA  
 230V-50Hz

NW  
 0.56kg

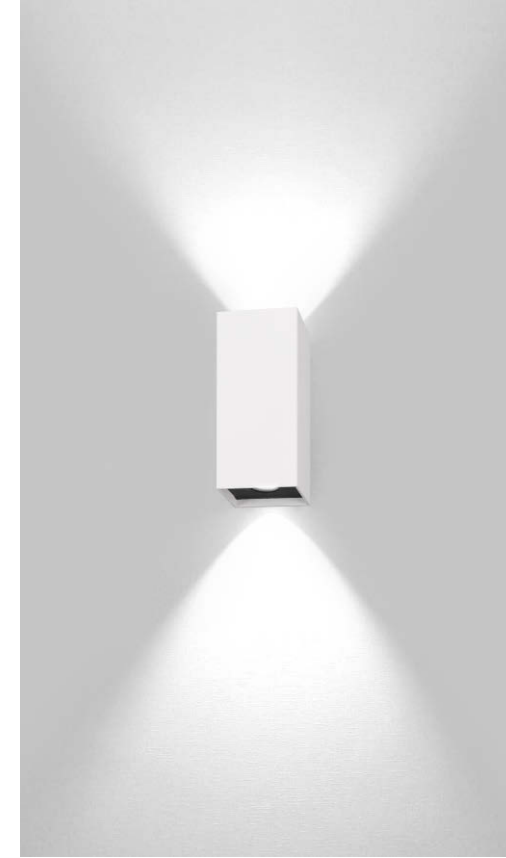

**COB LED CRI≥80 IP20 CE RoHS**  
 Housing color: White Silver Black Aluminum Brush  
 Color temperature: 2700K 3000K 4000K

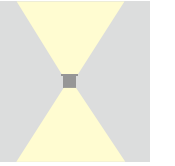

- Screwless design with magnetic mounted to make fixture looks more simple and elegant.
- Comfortable and symmetric light performance.
- Light housing: Pure aluminum.
- Surface mounted and no need wall-mounted plate.
- Light source: COB LED with a reflector of high optical.

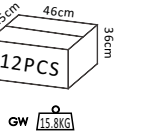
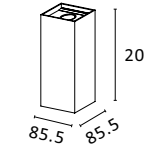

**W7500 2x8W 580lm**  
 With LED Driver 36V-180mA  
 230V-50Hz

NW  
 1.11kg

**COB LED CRI≥80 IP20 CE RoHS**  
 Housing color: White Silver Black Aluminum Brush  
 Color temperature: 2700K 3000K 4000K

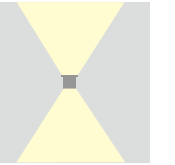

- Screwless design with magnetic mounted to make fixture looks more simple and elegant.
- Comfortable and symmetric light performance.
- Light housing: Pure aluminum.
- Surface mounted and no need wall-mounted plate.
- Light source: COB LED with a reflector of high optical.

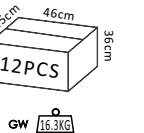
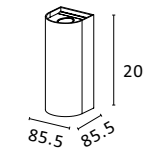

**W7600 2x8W 580lm**  
 With LED Driver 36V-180mA  
 230V-50Hz

NW  
 1.15kg



**COB LED CRI≥80 IP20 CE RoHS**  
 Housing color: White Silver Black Aluminum Brush  
 Color temperature: 2700K 3000K 4000K

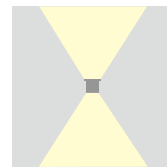

- Screwless design with magnetic mounted to make fixture looks more simple and elegant.
- Comfortable and symmetric light performance.
- Light housing: Pure aluminum.
- Surface mounted and no need wall-mounted plate.
- Light source: COB LED with a reflector of high optical.

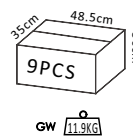
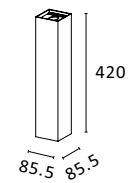

**W7501 2x8W 580lm**  
 With LED Driver 36V-180mA  
 230V-50Hz

NW 1.58kg

**COB LED CRI≥80 IP20 CE RoHS**  
 Housing color: White Silver Black Aluminum Brush  
 Color temperature: 2700K 3000K 4000K

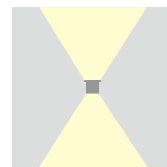

- Screwless design with magnetic mounted to make fixture looks more simple and elegant.
- Comfortable and symmetric light performance.
- Light housing: Pure aluminum.
- Surface mounted and no need wall-mounted plate.
- Light source: COB LED with a reflector of high optical.

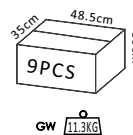
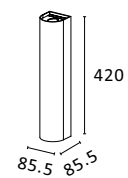

**W7601 2x8W 580lm**  
 With LED Driver 36V-180mA  
 230V-50Hz

NW 1.47kg

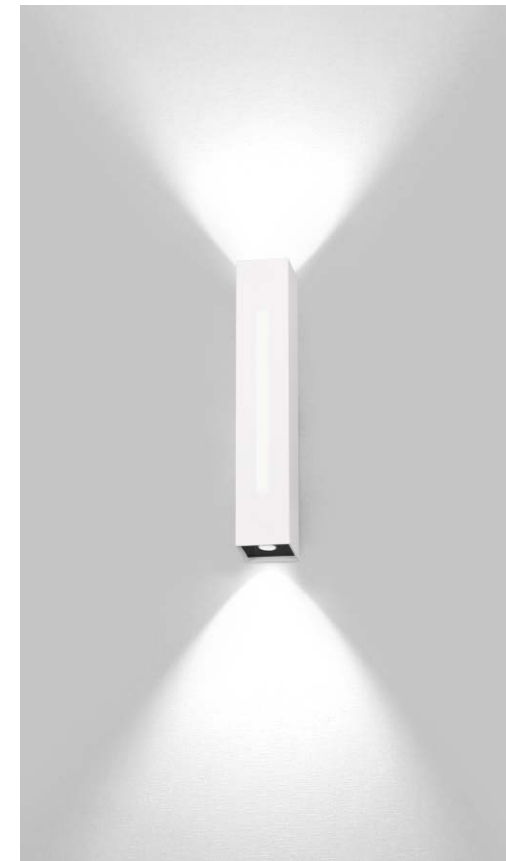

**COB LED CRI≥80 IP20 CE RoHS**  
 Housing color: White Silver Black Aluminum Brush  
 Color temperature: 2700K 3000K 4000K

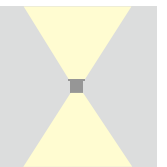

- Screwless design with magnetic mounted to make fixture looks more simple and elegant.
- Comfortable and symmetric light performance.
- Light housing: Pure aluminum.
- Surface mounted and no need wall-mounted plate.
- Light source: COB LED with a reflector of high optical and SMD LED with acrylic diffuser.

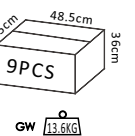
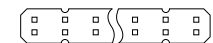
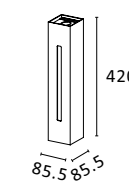

**W7503 COB2x8W+SMD5W 830lm**  
 With LED Driver 36V-180mA+36V-135mA  
 230V-50Hz

NW 1.85kg

**COB LED CRI≥80 IP20 CE RoHS**  
 Housing color: White Silver Black Aluminum Brush  
 Color temperature: 2700K 3000K 4000K

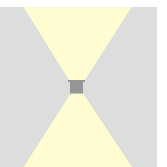

- Screwless design with magnetic mounted to make fixture looks more simple and elegant.
- Comfortable and symmetric light performance.
- Light housing: Pure aluminum.
- Surface mounted and no need wall-mounted plate.
- Light source: COB LED with a reflector of high optical and SMD LED with acrylic diffuser.

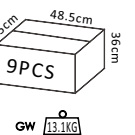
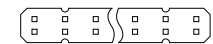
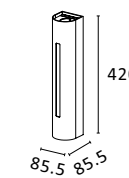

**W7603 COB2x8W+SMD5W 830lm**  
 With LED Driver 36V-180mA+36V-135mA  
 230V-50Hz

NW 1.77kg



**COB LED CRI≥80 IP20 CE RoHS**  
 Housing color: White Silver Black Aluminum Brush  
 Color temperature: 2700K 3000K 4000K

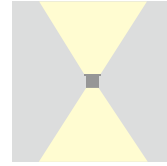

- Screwless design with magnetic mounted to make fixture looks more simple and elegant.
- Comfortable and symmetric light performance.
- Light housing: Pure aluminum.
- Surface mounted and no need wall-mounted plate.
- Light source: COB LED with a reflector of high optical.

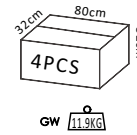
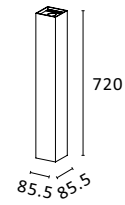

**W7502 2x8W 580lm**  
 With LED Driver 36V-180mA  
 230V-50Hz



**COB LED CRI≥80 IP20 CE RoHS**  
 Housing color: White Silver Black Aluminum Brush  
 Color temperature: 2700K 3000K 4000K

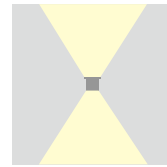

- Screwless design with magnetic mounted to make fixture looks more simple and elegant.
- Comfortable and symmetric light performance.
- Light housing: Pure aluminum.
- Surface mounted and no need wall-mounted plate.
- Light source: COB LED with a reflector of high optical.

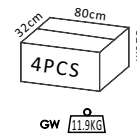
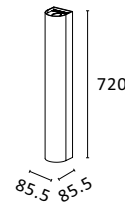

**W7602 2x8W 580lm**  
 With LED Driver 36V-180mA  
 230V-50Hz

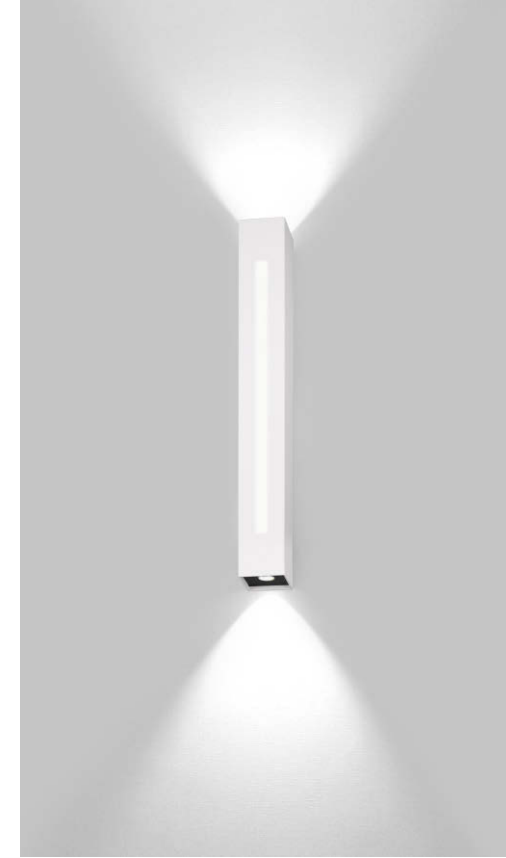

**COB LED CRI≥80 IP20 CE RoHS**  
 Housing color: White Silver Black Aluminum Brush  
 Color temperature: 2700K 3000K 4000K

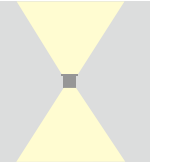

- Screwless design with magnetic mounted to make fixture looks more simple and elegant.
- Comfortable and symmetric light performance.
- Light housing: Pure aluminum.
- Surface mounted and no need wall-mounted plate.
- Light source: COB LED with a reflector of high optical and SMD LED with acrylic diffuser.

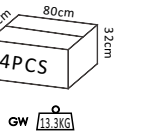
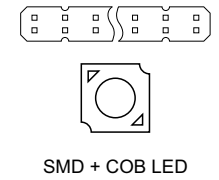
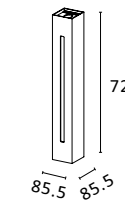

**W7504 COB2x8W+SMD10W 960lm**  
 With LED Driver 36V-180mA+24V-350mA  
 230V-50Hz



**COB LED CRI≥80 IP20 CE RoHS**  
 Housing color: White Silver Black Aluminum Brush  
 Color temperature: 2700K 3000K 4000K

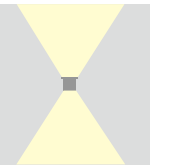

- Screwless design with magnetic mounted to make fixture looks more simple and elegant.
- Comfortable and symmetric light performance.
- Light housing: Pure aluminum.
- Surface mounted and no need wall-mounted plate.
- Light source: COB LED with a reflector of high optical and SMD LED with acrylic diffuser.

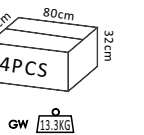
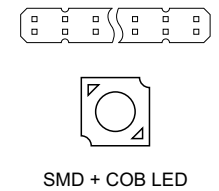
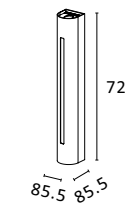

**W7604 COB2x8W+SMD10W 960lm**  
 With LED Driver 36V-180mA+24V-350mA  
 230V-50Hz





COB LED	CRI≥80	IP20	CE	RoHS
Housing color:	White	Silver	Black	
Color temperature:	2700K	3000K	4000K	

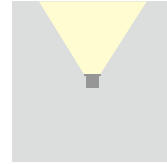

- Light housing: Pure aluminum.
- Wall-mounted plate: Steel sheet.
- Light source: COB LED.
- Included LED driver.

W6102 5W 383lm  
With LED Driver 9V-350mA  
230V-50Hz

NW  
0.31kg

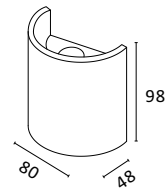

COB LED

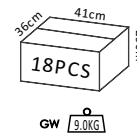

GW 5.0KG



COB LED	CRI≥80	IP20	CE	RoHS
Housing color:	White	Silver	Black	
Color temperature:	2700K	3000K	4000K	

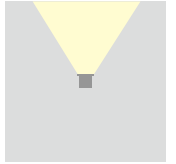

- Luminaire housing: Cast aluminum.
- Wall-mounted plate: Stainless sheet.
- Light source: COB LED.
- Included LED driver.

W6014 5W 383lm  
With LED Driver 9V-350mA  
230V-50Hz

NW  
0.26kg

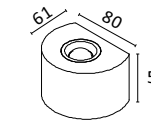

COB LED

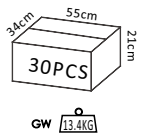

GW 13.4KG



COB LED	CRI≥80	IP20	CE	RoHS
Housing color:	White	Silver	Black	Aluminum Brush
Color temperature:	2700K	3000K	4000K	

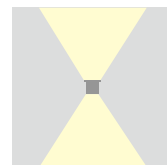

- Light housing: Pure aluminum.
- Wall-mounted plate: Steel sheet.
- Light source: COB LED.
- Included LED driver.

W6036 2x3W 468lm  
With LED Driver 9V-500mA  
230V-50Hz

NW  
0.37kg

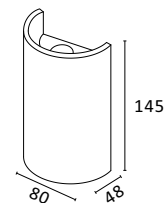

COB LED

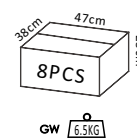

GW 6.5KG

COB LED	CRI≥80	IP20	CE	RoHS
Housing color:	White	Silver	Black	
Color temperature:	2700K	3000K	4000K	

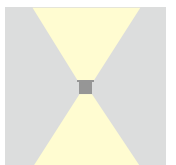

- Luminaire housing: Pure aluminum.
- Wall-mounted plate: Steel sheet.
- Light source: COB LED with a lens of optical.
- Included LED driver.

W6001 2x5W 900lm  
With LED Driver 36V-250mA  
230V-50Hz

NW  
0.74kg

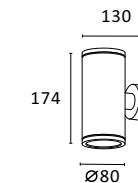

COB LED

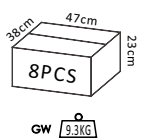

GW 6.3KG





W6016 5W 380lm  
With LED Driver 9V-350mA  
230V-50Hz

NW  
0.32kg

COB LED	CRI≥80	IP20	CE	RoHS
Housing color:	White	Brush	Black	
Color temperature:	2700K	3000K	4000K	

- Luminaire housing: Pure aluminum.
- Wall-mounted plate: Stainless sheet.
- Light source: COB LED with a lens of optical.
- Included LED driver.

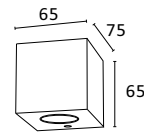
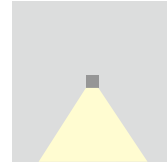

COB LED

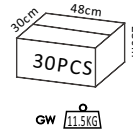

GW 11.5kg



W6019 2x3W 450lm  
With LED Driver 9V-500mA  
230V-50Hz

NW  
0.38kg

COB LED	CRI≥80	IP20	CE	RoHS
Housing color:	White	Brush	Black	
Color temperature:	2700K	3000K	4000K	

- Luminaire housing: Pure aluminum.
- Wall-mounted plate: Stainless sheet.
- Light source: COB LED with a lens of optical.
- Included LED driver.

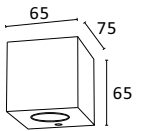
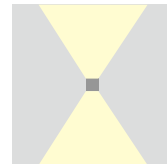

COB LED

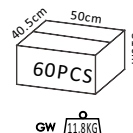

GW 11.8kg



W6171 2x5W 800lm  
With LED Driver 36V-250mA  
230V-50Hz

NW  
1.94kg

COB LED	CRI≥80	IP20	CE	RoHS
Housing color:	White	Silver	Black	
Color temperature:	2700K	3000K	4000K	

- Luminaire housing: Pure aluminum.
- Wall-mounted plate: Steel sheet.
- Light source: COB LED with a lens of optical.
- Included LED driver.

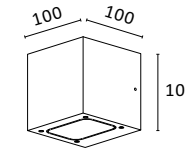
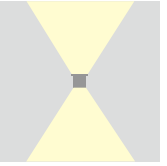

COB LED

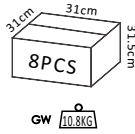

GW 10.8kg



**SMD LED CRI≥80 IP20 CE RoHS**  
 Housing color: White Silver Black  
 Color temperature: 2700K 3000K 4000K



- Housing: Aluminum sheet.
- Light source: SMD LED.
- Included LED driver.

**R6008 1W 35lm**  
 With LED Driver 3V-350mA  
 230V-50Hz

NW  
 0,09kg

**R6008 3W 68lm**  
 With LED Driver 3V-700mA  
 230V-50Hz

NW  
 0,09kg

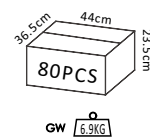
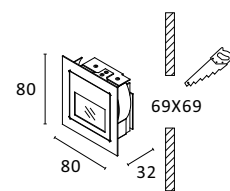

**5058**  
 Accessories  
 For model: R6008 R6803

NW  
 0,13kg

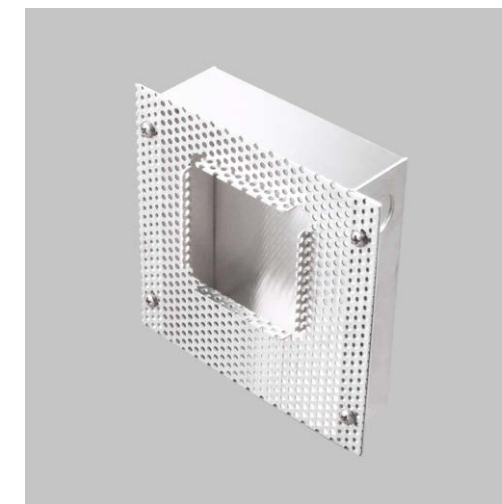

**CE RoHS**

- Recessed kit in brickwork: Aluminum sheet.

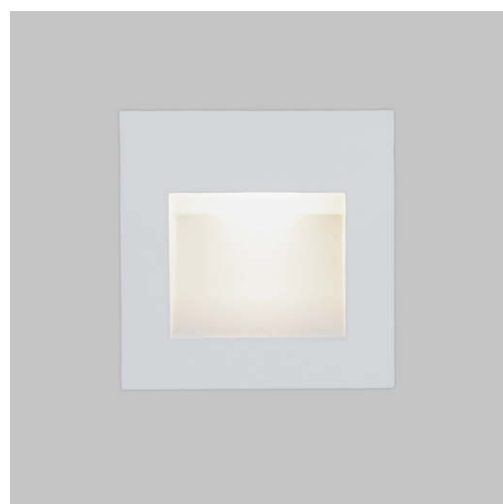
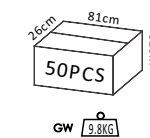
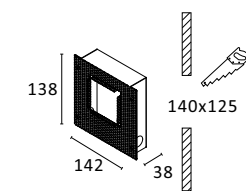

**COB LED CRI≥80 IP20 CE RoHS**  
 Housing color: White Silver Black  
 Color temperature: 2700K 3000K 4000K

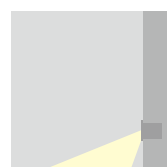

- Housing: Cast Aluminum.
- Light source: COB LED.
- Included LED driver.

**R6803 1W 49lm**  
 With LED Driver 3V-350mA  
 230V-50Hz

NW  
 0,28kg

**R6803 3W 190lm**  
 With LED Driver 9V-350mA  
 230V-50Hz

NW  
 0,28kg

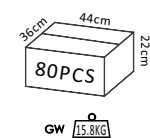
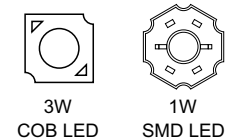
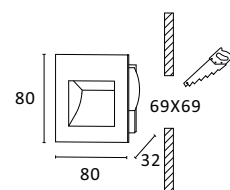

WALA Exterior



**COB LED CRI≥80 IP54 CE RoHS**  
 Housing color: White Silver Black  
 Color temperature: 2700K 3000K 4000K

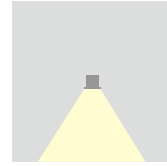

- Luminaire housing: Cast aluminum.
- Wall-mounted plate: Stainless sheet.
- Light source: COB LED with an optical lens and glass.
- Included LED driver.

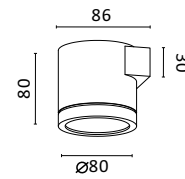

COB LED

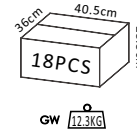

**E6018 5W 500lm**  
 With LED Driver 9V-500mA  
 230V-50Hz

NW  
 0.58kg

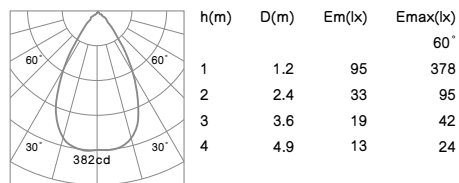
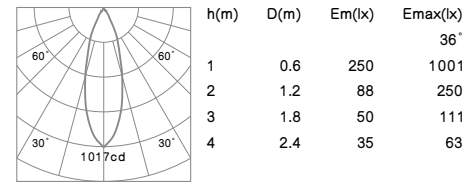
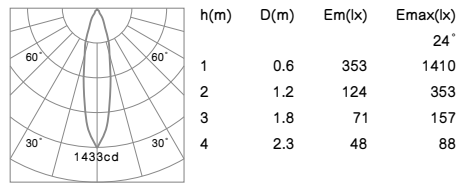

WALA Exterior



**COB LED CRI≥80 IP54 CE RoHS**  
 Housing color: White Silver Black  
 Color temperature: 2700K 3000K 4000K

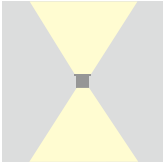

- Luminaire housing: Pure aluminum.
- Wall-mounted plate: Stainless sheet.
- Light source: COB LED with an optical lens and glass.
- Included LED driver.

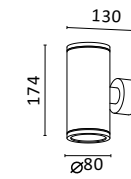

COB LED

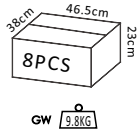

**E6029 2x5W 900lm**  
 With LED Driver 36V-250mA  
 230V-50Hz

NW  
 0.74kg

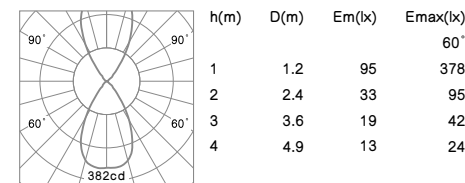
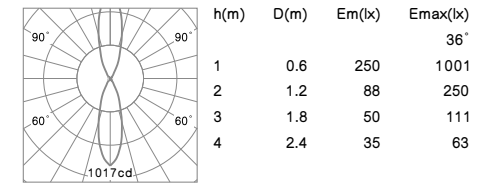
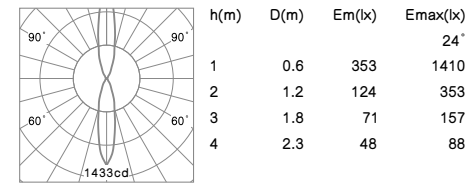

WALA Exterior



**COB LED CRI≥80 IP54 CE RoHS**  
 Housing color: White Silver Black  
 Color temperature: 2700K 3000K 4000K

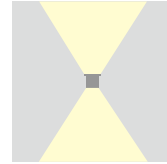

- Luminaire housing: Pure aluminum.
- Wall-mounted plate: Cast aluminum.
- Light source: COB LED with an optical lens and glass.
- Included LED driver.

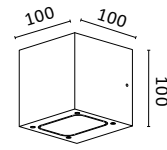

COB LED

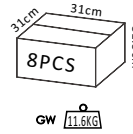

**E6016 2x5W 800lm**  
 With LED Driver 36V-250mA  
 230V-50Hz

NW  
 1.94kg

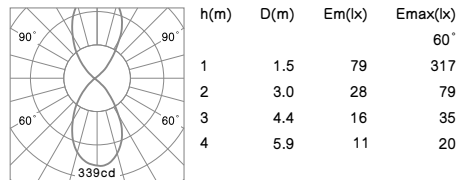
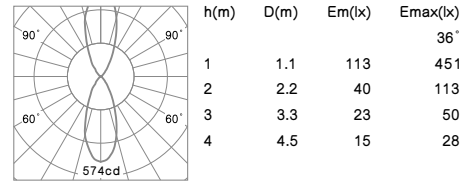
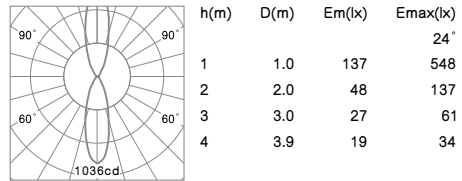

WALA Exterior



**COB LED CRI≥80 IP54 CE RoHS**  
 Housing color: White Silver Black  
 Color temperature: 2700K 3000K 4000K

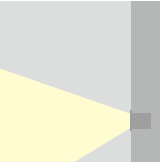

- Housing for recessed mounting in brickwork cast aluminum with a plastic recessed box.
- Light source: COB LED with an optical lens and glass.
- Included LED driver.

**E6170 5W 400lm**  
 With LED Driver 9V-500mA  
 230V-50Hz

NW  
 0.40kg

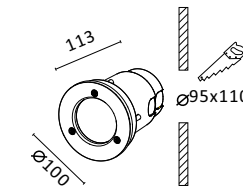

COB LED

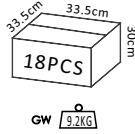





**COB LED CRI≥80 IP54 CE RoHS**  
 Housing color: White Silver Black  
 Color temperature: 2700K 3000K 4000K



- Housing for recessed mounting in brickwork cast aluminum with a plastic recessed box.
- Light source: COB LED with an optical lens and glass.
- Included LED driver.

**E6007 5W 100lm**  
 With LED Driver 9V-500mA  
 230V-50Hz

NW  
 0.52kg

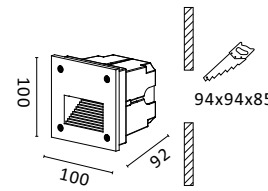

COB LED

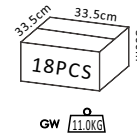

GW 11.0KG



**COB LED CRI≥80 IP54 CE RoHS**  
 Housing color: White Silver Black  
 Color temperature: 2700K 3000K 4000K



- Housing for recessed mounting in brickwork cast aluminum with a plastic recessed box.
- Light source: COB LED with an optical lens and glass.
- Included LED driver.

**E6031 2x5W 170lm**  
 With LED Driver 36V-250mA  
 230V-50Hz

NW  
 0.67kg

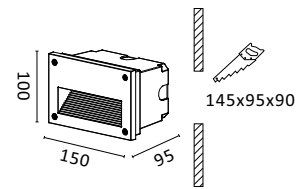

COB LED

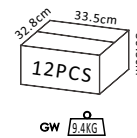

GW 5.4KG



**COB LED CRI≥80 IP54 CE RoHS**  
 Housing color: White Silver Black  
 Color temperature: 2700K 3000K 4000K



- Housing for recessed mounting in brickwork cast aluminum with a plastic recessed box.
- Light source: COB LED with an optical lens and glass.
- Included LED driver.

**E6013 5W 100lm**  
 With LED Driver 9V-500mA  
 230V-50Hz

NW  
 0.60kg

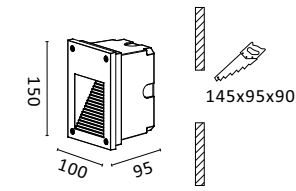

COB LED

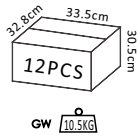

GW 10.5KG

OFFICE



507

OFFICE



SMD LED  
Lens of optical

Anti-glare

Office Lighting

Recessed  
Pendant

508

OFFICE

Oval wide flood  
120°

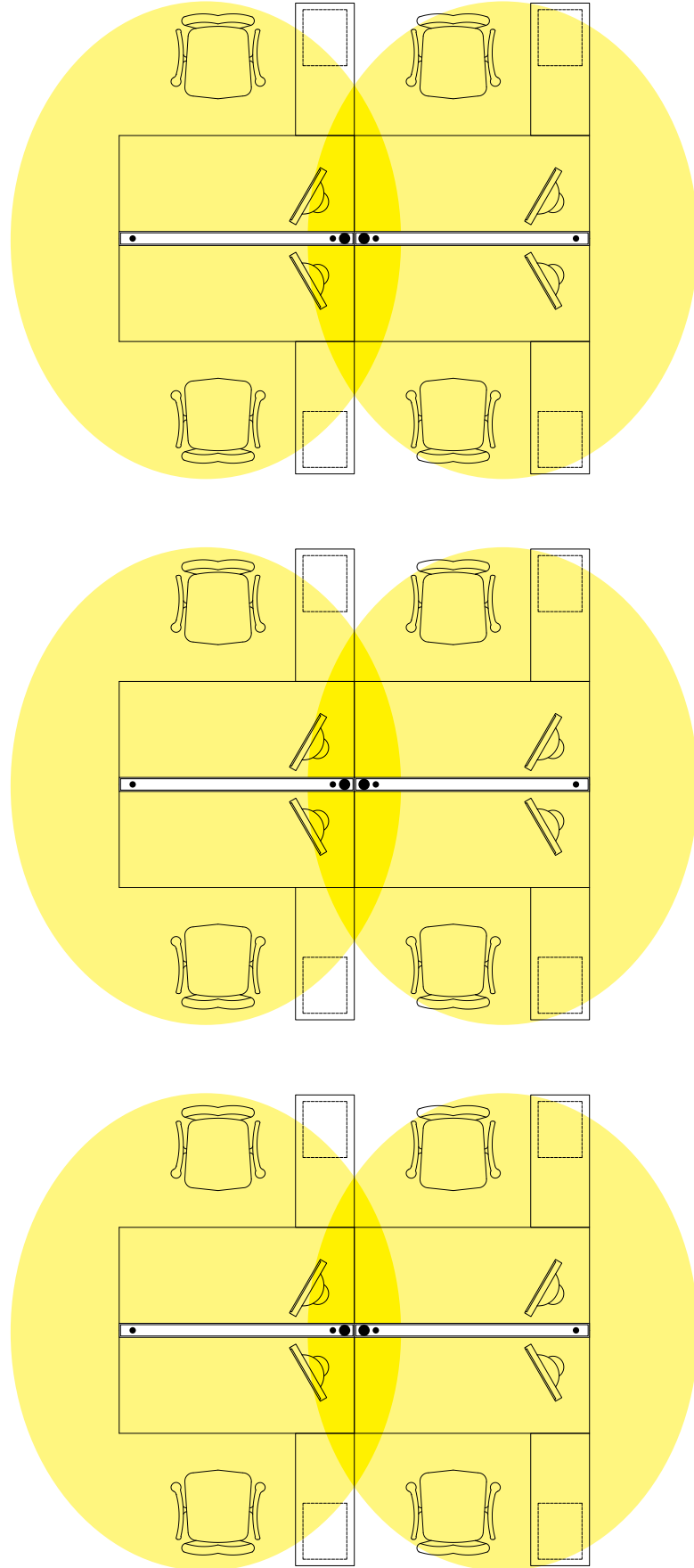

OFFICE









OFFICE



OFFICE

Recessed



1150x52x84mm 18W/36W

P515



1460x52x84mm 28W/46W

P515



1146x65x78mm 18W/36W

P516

Pendant



880x37x70mm 28W

P517



1440x37x70mm 28W/46W

P517



1136x37x70mm 18W/36W

P518



1130x60x75mm 18W/36W

P518

# OFFICE Recessed

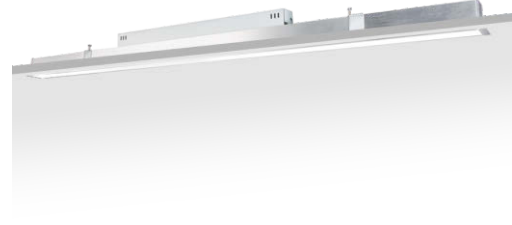

**SMD LED** **CRI≥80** **IP20** **CE** **RoHS**

Housing color: White Silver Black Anodising Brush  
 Color temperature: 3000K 4000K 6000K

Driver gear for LED: Non-Dimmable  
 1-10V Dimmable  
 DALI Dimmable

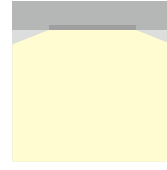

- The lamp body is made of pure aluminum and is molded through extrusion and then shaped by CNC machines: the surface is oxidized after brushing or electrostatic thermo-painting finish.
- Germany imported high transmittance PMMA diffuser specially designed for LED light sources creating a high visual comfort and very uniform lighting distributions.
- Tuneable white dimming control is available.
- Seamless continuous lighting system without dark spots available.
- Exquisite design for the dimension of the lighting fixture.
- Applications: offices , educational institutes ,hospitals, warehouses , meeting rooms, schools and showrooms.

**R3010 18W 1540lm**  
 AC 230V or With LED Driver 36V-500mA  
 230V-50Hz

NW  
 1.95kg

**R3010 36W 2500lm**  
 AC 230V or With LED Driver 36V-900mA  
 230V-50Hz

NW  
 1.95kg

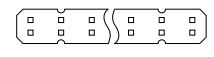
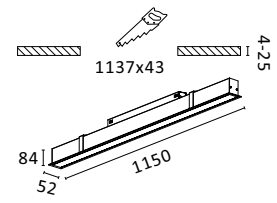

SMD LED



GW 15.0KG

**SMD LED** **CRI≥80** **IP20** **CE** **RoHS**

Housing color: White Silver Black Anodising Brush  
 Color temperature: 3000K 4000K 6000K

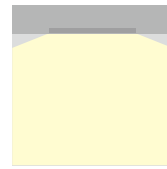

- The lamp body is made of pure aluminum and is molded through extrusion and then shaped by CNC machines: the surface is oxidized after brushing or electrostatic thermo-painting finish.
- Germany imported high transmittance PMMA diffuser specially designed for LED light sources creating a high visual comfort and very uniform lighting distributions.
- Tuneable white dimming control is available.
- Seamless continuous lighting system without dark spots available.
- Exquisite design for the dimension of the lighting fixture.
- Applications: offices , educational institutes ,hospitals, warehouses , meeting rooms, schools and showrooms.

**R3011 28W 2200lm**  
 AC 230V or With LED Driver  
 36V-500mA+2x15V-350mA  
 230V-50Hz

NW  
 2.30kg

**R3011 46W 3150lm**  
 AC 230V or With LED Driver  
 36V-900mA+2x15V-350mA  
 230V-50Hz

NW  
 2.30kg

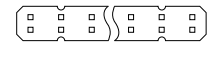
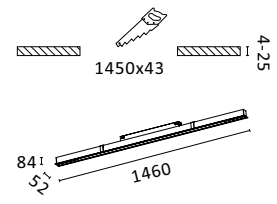

SMD LED

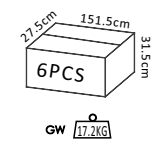

GW 17.2KG

# OFFICE Recessed



**SMD LED** **CRI≥80** **IP20** **CE** **RoHS**

Housing color: White Silver Black Anodising Brush  
 Color temperature: 3000K 4000K 6000K

Driver gear for LED: Non-Dimmable  
 1-10V Dimmable  
 DALI Dimmable



- The lamp body is made of pure aluminum and is molded through extrusion and then shaped by CNC machines: the surface is oxidized after brushing or electrostatic thermo-painting finish.
- Germany imported high transmittance PMMA diffuser specially designed for LED light sources creating a high visual comfort and very uniform lighting distributions.
- Tuneable white dimming control is available.
- Seamless continuous lighting system without dark spots available.
- Applications: offices , educational institutes ,hospitals, warehouses , meeting rooms, schools and showrooms.

**R3009 18W 1540lm**  
 AC 230V or With LED Driver 36V-500mA  
 230V-50Hz

NW  
 2.10kg

**R3009 36W 2500lm**  
 AC 230V or With LED Driver 36V-900mA  
 230V-50Hz

NW  
 2.10kg

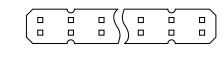
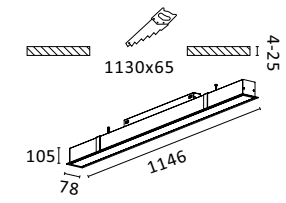

SMD LED

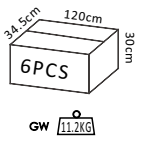

GW 11.2KG

# OFFICE Pendant



**SMD LED CRI≥80 IP20 CE RoHS**

Housing color: White Silver Black Anodising Brush  
 Color temperature: 3000K 4000K 6000K

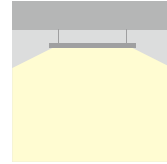

- The lamp body is made of pure aluminum and is molded through extrusion and then shaped by CNC machines: the surface is oxidized after brushing or electrostatic thermo-painting finish.
- Germany imported high transmittance PMMA diffuser specially designed for LED light sources creating a high visual comfort and very uniform lighting distributions.
- Tuneable white dimming control is available.
- Seamless continuous lighting system without dark spots available.
- Exquisite design for the dimension of the lighting fixture.
- Applications: offices , educational institutes ,hospitals, warehouses , meeting rooms, schools and showrooms.

**F3175 28W 2100lm**  
 AC 230V or With LED Driver 36V-500mA+2x15V-350mA  
 230V-50Hz

NW  
 1.88kg

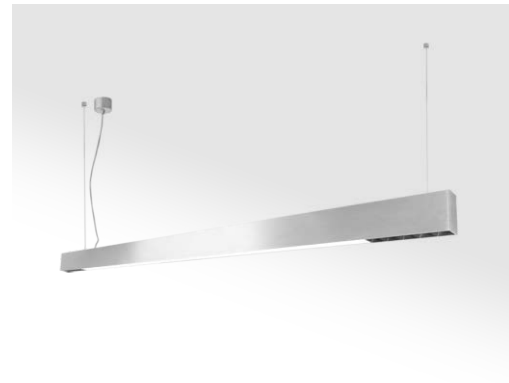
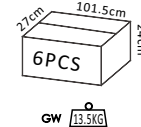
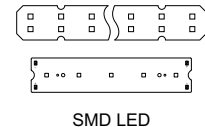
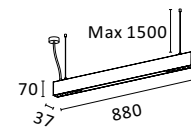

**SMD LED CRI≥80 IP20 CE RoHS**

Housing color: White Silver Black Anodising Brush  
 Color temperature: 3000K 4000K 6000K

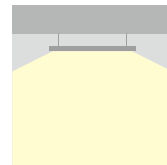

- The lamp body is made of pure aluminum and is molded through extrusion and then shaped by CNC machines: the surface is oxidized after brushing or electrostatic thermo-painting finish.
- Germany imported high transmittance PMMA diffuser specially designed for LED light sources creating a high visual comfort and very uniform lighting distributions.
- Tuneable white dimming control is available.
- Seamless continuous lighting system without dark spots available.
- Exquisite design for the dimension of the lighting fixture.
- Applications: offices , educational institutes ,hospitals, warehouses , meeting rooms, schools and showrooms.

**F3176 28W 2200lm**  
 AC 230V or With LED Driver 36V-500mA+2x15V-350mA  
 230V-50Hz

NW  
 2.50kg

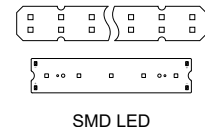
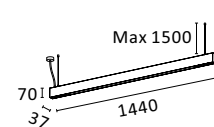

# OFFICE Pendant



**SMD LED CRI≥80 IP20 CE RoHS**

Housing color: White Silver Black Anodising Brush  
 Color temperature: 3000K 4000K 6000K

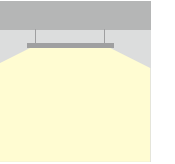

- The lamp body is made of pure aluminum and is molded through extrusion and then shaped by CNC machines: the surface is oxidized after brushing or electrostatic thermo-painting finish.
- Germany imported high transmittance PMMA diffuser specially designed for LED light sources creating a high visual comfort and very uniform lighting distributions.
- Tuneable white dimming control is available.
- Seamless continuous lighting system without dark spots available.
- Exquisite design for the dimension of the lighting fixture.
- Applications: offices , educational institutes ,hospitals, warehouses , meeting rooms, schools and showrooms.

**F3177 18W 1100lm**  
 AC 230V or With LED Driver 36V-500mA  
 230V-50Hz

NW  
 1.95kg

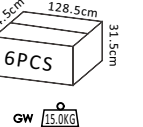
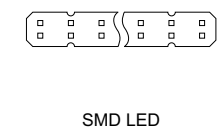
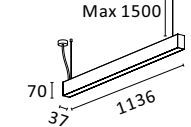

**SMD LED CRI≥80 IP20 CE RoHS**

Housing color: White Silver Black Anodising Brush  
 Color temperature: 3000K 4000K 6000K

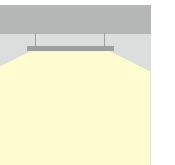

- The lamp body is made of pure aluminum and is molded through extrusion and then shaped by CNC machines: the surface is oxidized after brushing or electrostatic thermo-painting finish.
- Germany imported high transmittance PMMA diffuser specially designed for LED light sources creating a high visual comfort and very uniform lighting distributions.
- Tuneable white dimming control is available.
- Seamless continuous lighting system without dark spots available.
- Applications: offices , educational institutes ,hospitals, warehouses , meeting rooms, schools and showrooms.

**F7007 18W 1100lm**  
 AC 230V or With LED Driver 36V-500mA  
 230V-50Hz

NW  
 2.30kg

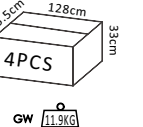
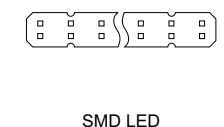
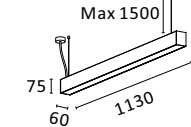

Accessories: connecting plate

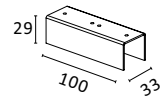

Small connecting bracket

Suitable for:  
F3175 / F3176 / F3177

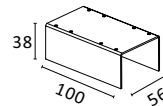

Large connecting bracket

Suitable for:  
F7007

Connecting plate installation spec

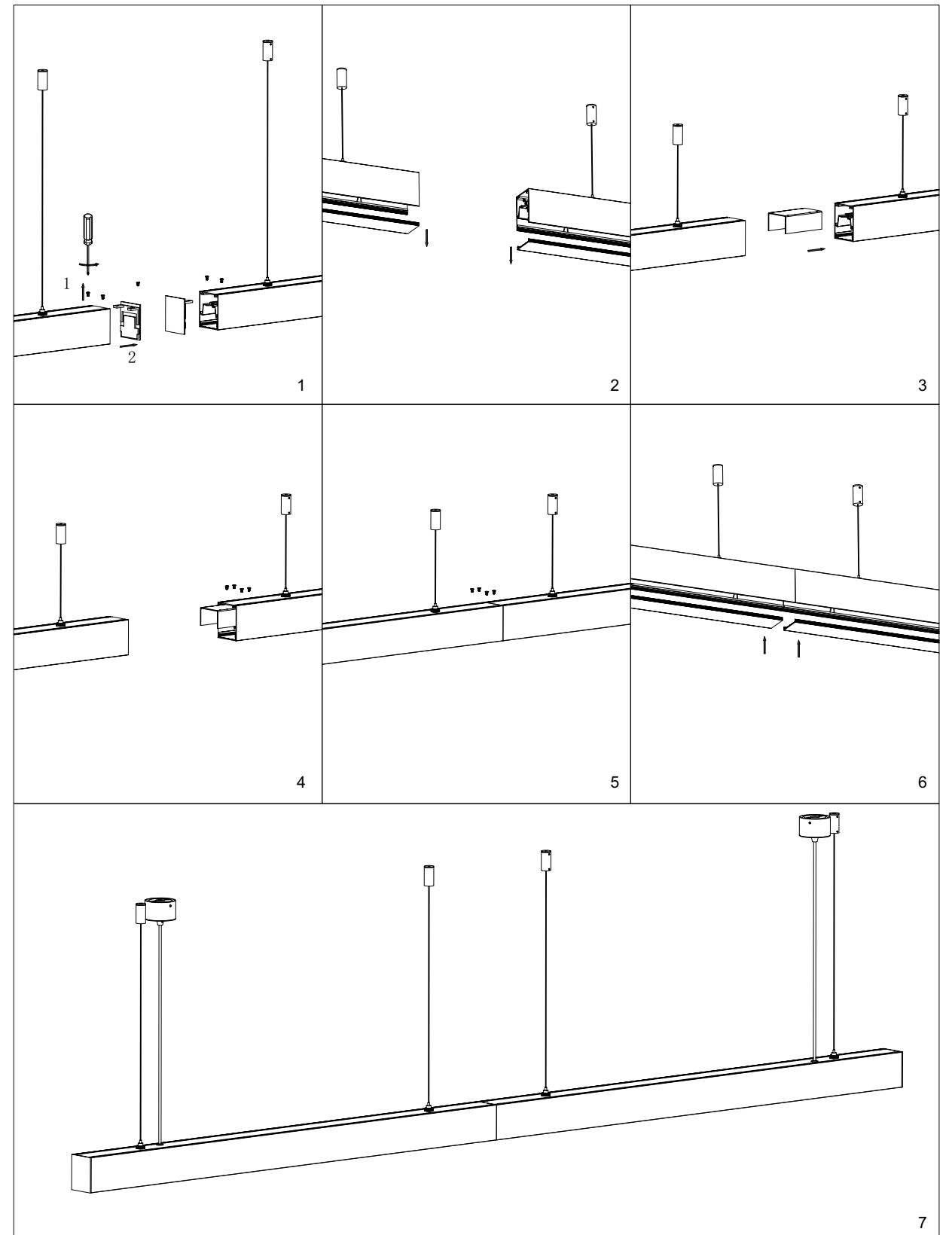









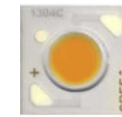









DRIVER















LIGHT SOURCE



## DATA









	Code	Lamp cap	Voltage (V)	Power (W)	Luminous flux (lm)	Luminous intensity (cd)	Beam angle (°)	Colour temperature (K)	
	QT9	G4	12	20	300			3000	
	QT12	GY6.35	12	50	910			3000	
	QT12	GY6.35	12	75	1450			3000	
	QT12	GY6.35	12	100	2200			3000	
	QR-CBC51	GU5.3	12	20		6000	10	3000	
	QR-CBC51	GU5.3	12	20		2300	24	3000	
	QR-CBC51	GU5.3	12	20		1000	36	3000	
	QR-CBC51	GU5.3	12	35		12500	10	3000	
	QR-CBC51	GU5.3	12	35		4400	24	3000	
	QR-CBC51	GU5.3	12	35		2200	36	3000	
	QR-CBC51	GU5.3	12	50		15000	10	3000	
	QR-CBC51	GU5.3	12	50		5700	24	3000	
	QR-CBC51	GU5.3	12	50		2850	36	3000	
	QR-LP111	G53	12	50		40000	8	3000	
	QR-LP111	G53	12	50		20000	24	3000	
	QR-LP111	G53	12	50		4000	45	3000	
	QR-LP111	G53	12	75		30000	8	3000	
	QR-LP111	G53	12	75		5300	24	3000	
	QR-LP111	G53	12	75		2000	45	3000	
	QR-LP111	G53	12	100		4800	8	3000	
	QR-LP111	G53	12	100		8500	24	3000	
	QR-LP111	G53	12	100		2800	45	3000	
		H-PIN	G9	230	25	230			2900
		H-PIN	G9	230	40	460			2900
		H-PIN	G9	230	60	790			2900
	QPAR16	GU10	230	35		600	35	2900	
	QPAR16	GU10	230	50		950	35	2900	
	QPAR20	E27	230	50		3200	10	2900	
	QPAR20	E27	230	50		1000	30	2900	
	QPAR30	E27	230	75		6900	10	2900	
	QPAR30	E27	230	75		2200	40	2900	
	PAR38	E27	230	120		9300	12	2900	
	PAR38	E27	230	120		3100	30	2900	
	PAR56	GX16d	230	300		40000	9/15		
	PAR56	GX16d	230	300		9000	16/40		
	QT32	E27	230	100	1470				
	QT32	E27	230	150	2400				
	QT32	E27	230	230	4210				
	QT32	E27	230	230	4350				
	HIT-TM	PGJ5		20	1650			3000	
	HIT-CRI	G8.5		35	3500			3000	
	HIT-CRI	G8.5		35	3400			4200	
	HIT-CRI	G8.5		70	6600			3000	
	HIT-CRI	G8.5		70	6900			4200	
	HIT	G12		35	3500			3000	
	HIT	G12		35	3600			4200	
	HIT	G12		70	6800			3000	
	HIT	G12		70	7300			4200	
	HIT	G12		150	14500			3000	
	HIT	G12		150	15000			4200	
	HIT-DE	Rx7-s		70	6800			3000	
	HIT-DE	Rx7-s		70	6600			4200	
	HIT-DE	Rx7s-24		150	14500			3000	
	HIT-DE	Rx7s-24		150	14400			4200	

## DATA

	Code	Lamp cap	Voltage (V)	Power (W)	Luminous flux (lm)	Luminous intensity (cd)	Beam angle (°)	Colour temperature (K)	
	TC-D	G24d-1		10	600			2700-3000-4000	
	TC-D	G24d-1		13	900			2700-3000-4000	
	TC-D	G24d-2		18	1200			2700-3000-4000	
	TC-D	G24d-3		26	1800			2700-3000-4000	
	TC-DEL	G24q-1		10	600			2700-3000-4000	
	TC-DEL	G24q-1		13	900			2700-3000-4000	
	TC-DEL	G24q-2		18	1200			2700-3000-4000	
	TC-DEL	G24q-3		26	1800			2700-3000-4000	
	TC-T	Gx24d-1		13	900			2700-3000-4000	
	TC-T	Gx24d-2		18	1200			2700-3000-4000	
	TC-T	Gx24d-3		26	1800			2700-3000-4000	
	TC-TEL	Gx24q-1		13	900			2700-3000-4000	
	TC-TEL	Gx24q-2		18	1200			2700-3000-4000	
	TC-TEL	Gx24q-3		26	1800			2700-3000-4000	
	TC-TEL	Gx24q-3		32	2400			2700-3000-4000	
	TC-TEL	Gx24q-4		42	3200			2700-3000-4000	
	TC-DSE	E27	230	5	240			2700-3000-4000	
	TC-DSE	E27	230	7	400			2700-3000-4000	
	TC-DSE	E27	230	11	600			2700-3000-4000	
	TC-DSE	E27	230	15	900			2700-3000-4000	
	TC-DSE	E27	230	20	1230			2700-3000-4000	
	TC-DSE	E27	230	23	1530			2700-3000-4000	
	TC-DSE	E27	230	30	1900			2700-3000-4000	
		T16(FH)(T5)	G5		14	1100			6500
T16(FH)(T5)		G5		14	1200			4000	
T16(FH)(T5)		G5		14	1200			3500	
T16(FH)(T5)		G5		21	1750			6500	
T16(FH)(T5)		G5		21	1900			4000	
T16(FH)(T5)		G5		21	1900			3500	
T16(FH)(T5)		G5		28	2400			6500	
T16(FH)(T5)		G5		28	2600			4000	
T16(FH)(T5)		G5		28	2600			3500	
		T16(FQ)(T5)	G5		24	1600			6500
		T16(FQ)(T5)	G5		24	1750			4000
		T16(FQ)(T5)	G5		24	1750			3500
	T16(FQ)(T5)	G5		39	2850			6500	
	T16(FQ)(T5)	G5		39	3100			4000	
	T16(FQ)(T5)	G5		39	3100			3500	
	T16(FQ)(T5)	G5		54	4000			6500	
	T16(FQ)(T5)	G5		54	4450			4000	
	T16(FQ)(T5)	G5		54	4450			3500	
	T5FC	2GX13		55	3800			6500	
	T5FC	2GX13		55	4200			4000	
	T5FC	2GX13		55	4200			3000	
	LED QR-CB51	GU5.3	DC 12V	3 x 1W	140			3000	
	LED QR-CB51	GU5.3	DC 12V	3 x 1W	180			6000	
	LED QPAR16	GU10	230	3 x 1W	180			3000	
	LED QPAR16	GU10	230	3 x 1W	210			6000	
	Energy-Saving Lamp cup	GU10	230	7W				3000	
		GU10	230	7W				6000	
		GU10	230	9W				3000	
		GU10	230	9W				6000	
	LED PAR30	E27	230	7 x 1W	420			3000	
	LED PAR30	E27	230	7 x 1W	480			6000	
	LED spot light	E27	230	12 x 1W	700			3000	
	LED spot light	E27	230	12 x 1W	840			6000	

## ICONS

### symbol Description

	A luminaire in which protection against electric shock does not rely on basic insulation only, but which includes an additional safety precaution in such a way that means are provided for the connection of accessible conductive parts to the protective (earthing) conductor in the fixed wiring of the installation in such a way that accessible conductive parts cannot become live in the event of a failure of the basic insulation.
	A luminaire in which protection against electric shock does not rely on basic insulation only, but in which additional safety precautions such as double insulation or reinforced insulation are provided, there being no provision for protective earthing or reliance upon installation conditions.
	A luminaire in which protection against electric shock relies on supply at safety extra-low voltage (SELV) and in which voltages higher than those of SELV are not generated.
	All products subject to the EMC guideline 89/336 (electromagnetic compatibility) and the guideline 73/23 (low-voltage) meet the requirements therein and bear the CE symbol on their packaging.
	All luminaires meet the F requirements in accordance with EN 60598-1 and are suitable for mounting on normal inflammable mounting surfaces (housing parts).
<b>IP20</b>	All luminaires meet the requirements of protection mode IP20 and are not marked. Other protection modes are specified for each product.
	<b>Protection mode IP44</b> Splash proof protection against splashes from all directions.
	<b>Protection mode IP65</b> Protection against dust and strong jets of water from all directions.
	<b>Protection mode IP67</b> Protection against dust and against the results of temporary immersion.
	<b>Protection mode IP68xm</b> Protection against dust and against the results of continuous submersion up to a depth of *m.

## PRODUCT CODES

Model	Page	Model	Page	Model	Page	Model	Page	Model	Page	Model	Page
4001	453	C6038	378	P6026	398	R6178	334	R6259	206	R6364	307
4002	453	C6044	368	P6033	418	R6179	336	R6262	095	R6365	309
4003	453	C6045	367	P6034	419	R6180	338	R6270	146	R6803	499
4005	455	C6046	379	P6035	420	R6188	052	R6280	240	R6821	186
4006	455	C6047	311	P6040	421	R6190	204	R6282	170	R6830	222
4007	455	C6048	313	P6041	422	R6191	334	R6285	144	R6831	223
4008	455	C6049	380	R3009	516	R6192	336	R6286	069	R6842	229
4009	455	C6050	457	R3010	515	R6193	338	R6287	071	R6843	230
4010	455	C6051	375	R3011	515	R6195	134	R6288	340	R6864	188
4011	455	C6052	376	R6008	499	R6196	133	R6289	342	R6865	187
4012	455	C6054	467	R6011	226	R6197	157	R6290	344	R6866	214
4013	456	C6062	370	R6013	225	R6198	114	R6291	251	R6867	213
4014	456	C6063	469	R6015	228	R6199	115	R6292	254	R6894	022
4015	456	C6221	369	R6017	227	R6200	172	R6295	303	R6897	016
4016	456	C6234	366	R6018	232	R6201	136	R6296	034	R6900	083
4017	456	C6257	459	R6020	109	R6202	135	R6297	040	R6901	085
4018	454	C6264	371	R6083	247	R6203	339	R6298	053	R6902	091
4019	454	C6290	372	R6084	249	R6204	341	R6299	031	R6903	093
4020	454	C6300	461	R6087	267	R6205	343	R6300	037	R6904	087
4021	453	E6007	505	R6089	269	R6206	333	R6301	471	R6905	089
4022	453	E6013	506	R6092	158	R6207	335	R6302	475	R6918	349
4023	453	E6016	503	R6093	126	R6208	337	R6307	473	R6924	245
4024	456	E6018	501	R6094	131	R6209	327	R6308	478	R6925	265
4025	456	E6021	180	R6103	231	R6210	329	R6309	017	T6001	441
4026	456	E6022	181	R6104	111	R6211	331	R6310	019	T6002	445
4027	456	E6023	182	R6108	112	R6212	321	R6311	020	T6012	435
4028	456	E6024	183	R6116	211	R6213	323	R6314	205	T6017	437
5058	500	E6025	184	R6117	212	R6214	325	R6315	018	T6032	443
		E6026	185	R6118	216	R6215	110	R6316	128	T6033	448
C6002	386	E6027	021	R6121	207	R6216	063	R6319	196	T6099	439
C6003	386	E6028	015	R6136	051	R6217	064	R6321	132	W6001	496
C6004	385	E6029	502	R6140	169	R6218	156	R6324	215	W6014	496
C6005	385	E6031	505	R6141	209	R6229	065	R6325	160	W6016	497
C6019	233	E6170	504	R6146	171	R6230	067	R6326	137	W6019	497
C6021	363	F3175	517	R6153	105	R6231	271	R6327	138	W6036	495
C6023	234	F3176	517	R6154	106	R6232	274	R6334	195	W6102	495
C6024	365	F3177	518	R6155	328	R6233	277	R6335	194	W6171	498
C6025	364	F7007	518	R6156	330	R6235	280	R6338	055	W6186	489
C6026	463	P6002	388	R6157	332	R6236	283	R6340	011	W6187	489
C6027	351	P6003	388	R6158	322	R6237	286	R6341	012	W7500	490
C6028	353	P6004	387	R6159	324	R6238	328	R6342	013	W7501	491
C6029	410	P6005	387	R6160	326	R6239	330	R6343	014	W7502	493
C6030	409	P6016	404	R6161	210	R6240	332	R6356	322	W7503	492
C6031	408	P6017	405	R6171	113	R6245	239	R6357	324	W7504	494
C6032	407	P6018	406	R6172	154	R6248	116	R6358	326	W7600	490
C6033	377	P6022	394	R6173	155	R6249	203	R6360	297	W7601	491
C6034	465	P6023	395	R6175	340	R6254	108	R6361	299	W7602	493
C6035	373	P6024	396	R6176	342	R6255	107	R6362	301	W7603	492
C6036	374	P6025	397	R6177	344	R6256	202	R6363	305	W7604	494

# VENEZINA

## Contents

- All statements of surfaces are colour names only, not material specifications.
- All measurements are without obligation and can vary slightly.

## Catalogue

Concept / production;  
· VENEZINA-Team  
Printed in HongKong

The full or partial reproduction of this catalogue is not allowed without authorization.

[sales@venezina.com](mailto:sales@venezina.com)  
[www.venezina.com](http://www.venezina.com)